

Kinetix 5500 Drive Systems

Catalog Numbers 2198-H003-ERS, 2198-H008-ERS, 2198-H015-ERS, 2198-H025-ERS, 2198-H040-ERS, 2198-H070-ERS, 2198-H003-ERS2, 2198-H008-ERS2, 2198-H015-ERS2, 2198-H025-ERS2, 2198-H040-ERS2, 2198-H070-ERS2, 2198-CAPMOD-1300

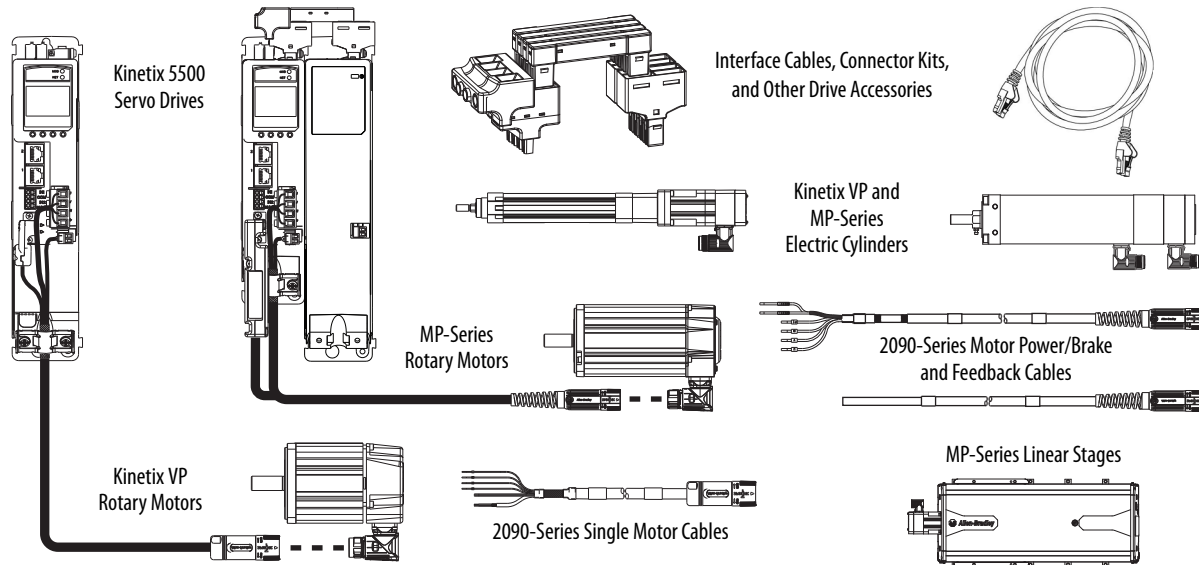

Topic	Page
Introduction	2
Safe Torque-off Configuration Options	3
Determine What You Need	6
Kinetix 5500 Shared-bus System Examples	10
2090-Series Single Motor Cable Overview	13
2090-Series Motor Power/Brake and Feedback Cables Overview	14
Rotary Motion System Combinations	
Kinetix VP Low Inertia Motors	16
Kinetix VP Food Grade Motors	32
Kinetix VP Hygienic Stainless Steel Motors	43
Kinetix VP Stainless Steel Motors	52

Topic, continued	Page
MP-Series Low Inertia Motors	53
MP-Series Medium Inertia Motors	64
MP-Series Food Grade Motors	72
MP-Series Stainless Steel Motors	77
Linear Motion System Combinations	
LDAT-Series Integrated Linear Thrusters	80
MP-Series Integrated Linear Stages	101
Kinetix VP Electric Cylinders	105
MP-Series Electric Cylinders	108
MP-Series Heavy Duty Electric Cylinders	110
Additional Resources	116



Summary of Changes

This publication contains new and updated information as indicated in the following table.

Topic	Page
Added compatibility with CompactLogix™ 5480 controllers.	3
Added compatibility with Kinetix® VP (Bulletin VPAR) electric cylinders.	7, 8
Added compatibility with Kinetix VP (Bulletin VPH) hygienic stainless-steel servo motors.	
Added compatibility with 2198-DBRxx-F AC line filters.	9
Corrected motor-rated output values for VPF-B1153E and VPF-B1153F servo motors.	38
Added performance specifications for Bulletin VPH servo motors with Kinetix 5500 drives.	43, 47
Added performance specifications for Bulletin VPAR electric cylinders with Kinetix 5500 drives.	105

Introduction

Use this publication if your application includes the Kinetix® 5500 drive family and Kinetix VP motors and actuators or any of the other compatible Allen-Bradley® motors and actuators. LDAT-Series linear thrusters and MP-Series™ motor and actuators require the 2198-H2DCK feedback converter kit. For more Kinetix drive and motor information, see the Kinetix Motion Control Selection Guide, publication [KNX-SG001](#), or Motion Analyzer software.

The purpose of this publication is to assist you in identifying the drive system components and accessory items you need for your Kinetix 5500 drive and motor/actuator combination. Diagrams in this publication illustrate how many of the common drive accessory items are used in a typical system. See the Kinetix Servo Drives Specifications Technical Data, publication [KNX-TD003](#), for detailed accessory descriptions and specifications.

Drive/motor system combinations also include the following:

- Motor/cable combinations table
- Drive and motor performance specifications table
- Torque/speed curves with each motor matched to the drive that provides optimum performance

Performance specification data and curves reflect nominal system performance of a typical system with motor/drive at rated ambient temperature and line voltage. For additional information on ambients, line conditions, and valid combinations that are not shown in this publication, refer to the Motion Analyzer system sizing and selection tool.

IMPORTANT These system combinations do not include all possible motor/drive combinations. See the Motion Analyzer system sizing and selection tool to verify compatibility. Access Motion Analyzer at <https://motionanalyzer.rockwellautomation.com>.

Safe Torque-off Configuration Options

Kinetix 5500 servo drives are available with safe torque-off over hardwired connections or integrated over the EtherNet/IP™ network. These examples illustrate the safe torque-off configuration options.

Hardwired Safety Configuration

The 2198-Hxxx-ERS drives use the safe torque-off (STO) connector for wiring external safety devices and cascading hardwired safety connections from one drive to another.

Safe Torque-off (hardwired) Configuration

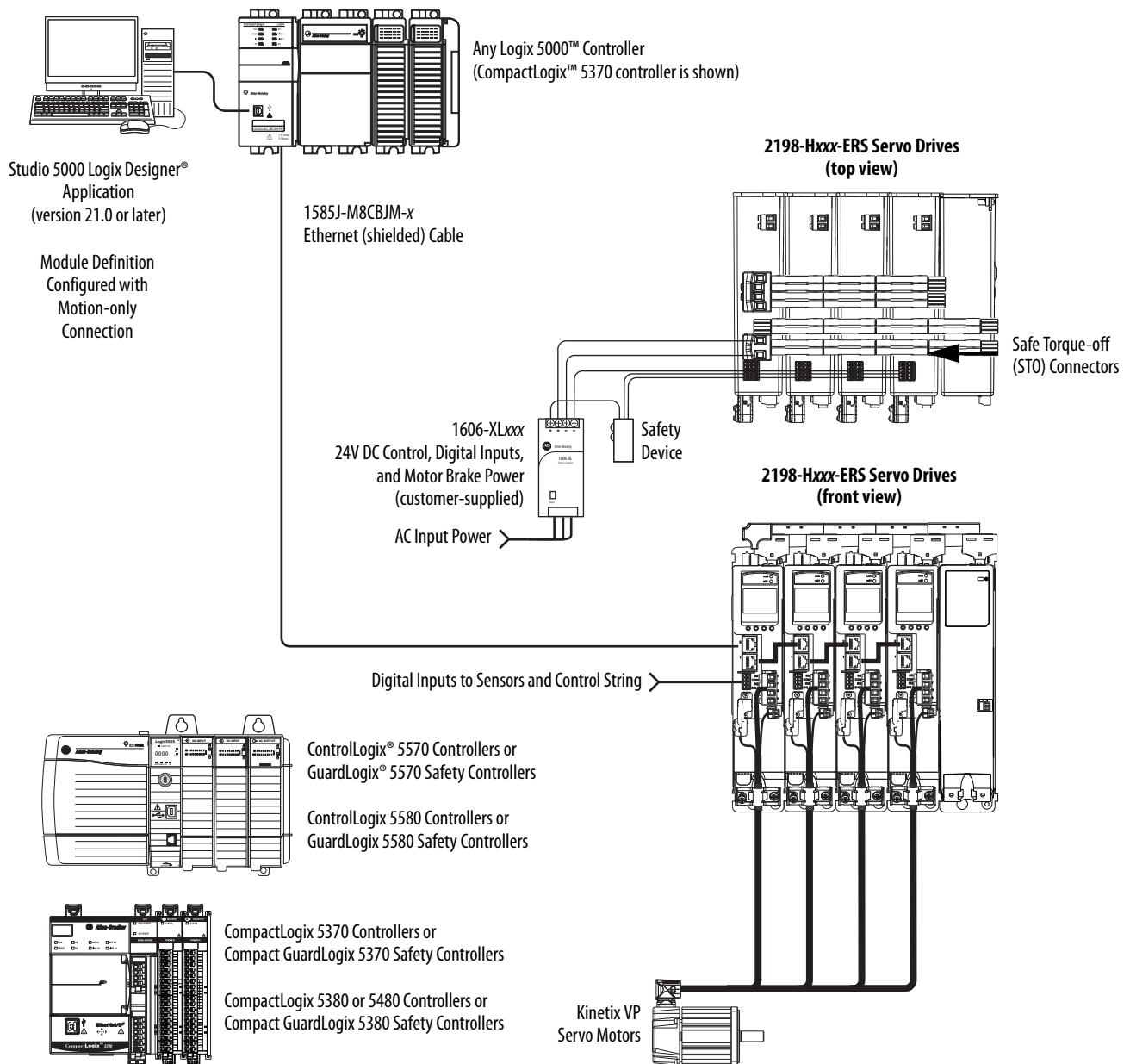

Integrated Safety Configurations

The GuardLogix 5570 or Compact GuardLogix 5370 safety controller issues the safe torque-off (STO) command over the EtherNet/IP network and the 2198-Hxxx-ERS2 drive executes the STO command.

In this example, a single GuardLogix safety controller makes the Motion and Safety connections with the 2198-Hxxx-ERS2 integrated safety drives.

IMPORTANT If only one controller is used in an application with Motion and Safety connections, it must be a GuardLogix 5570 or Compact GuardLogix 5370 safety controller.

Motion and Safety Configuration (single controller)

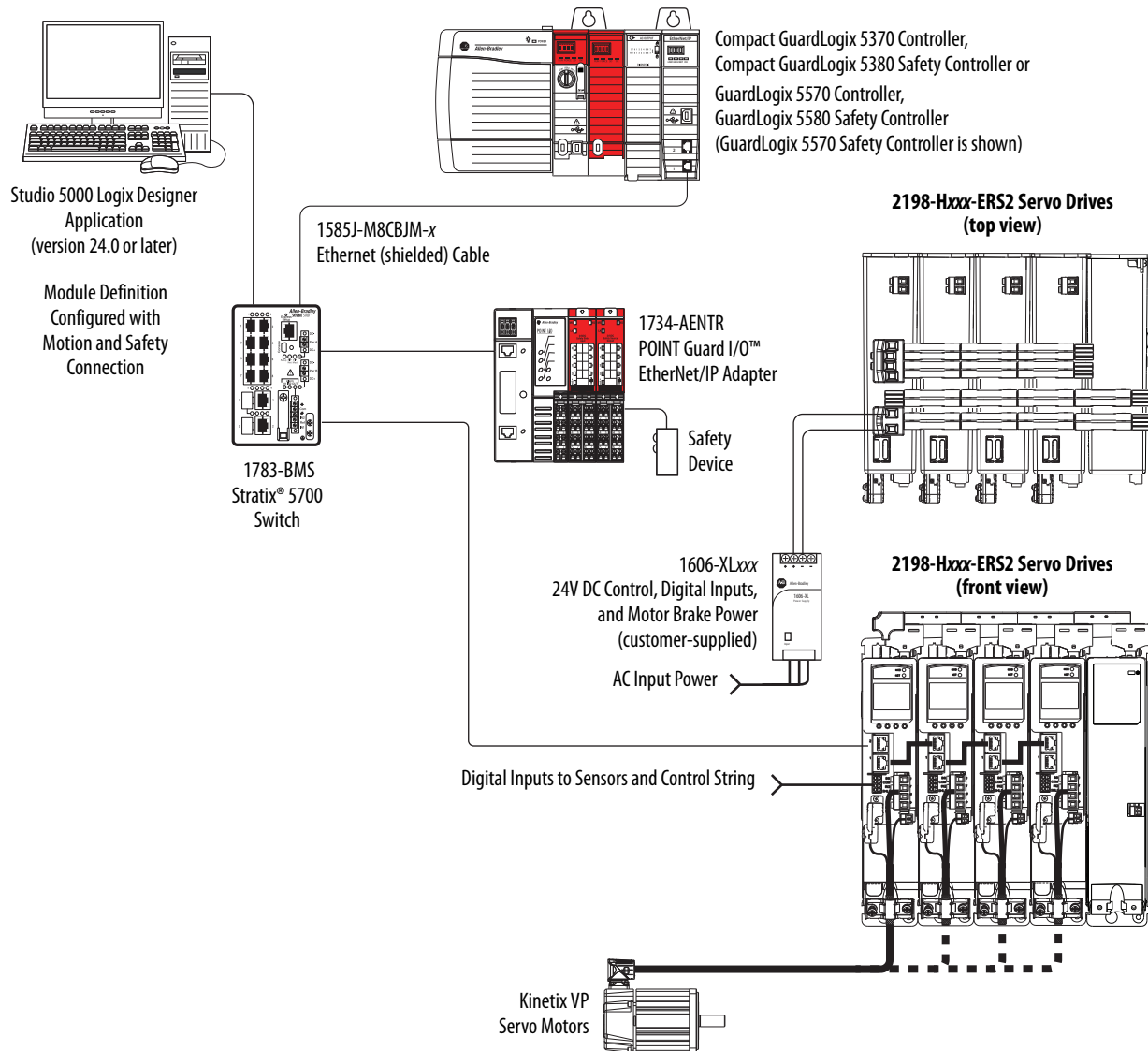

In this example, a non-safety controller makes the Motion-only connection and a separate GuardLogix safety controller makes the Safety-only connection with the 2198-Hxxx-ERS2 integrated safety drives.

IMPORTANT If two controllers are used in an application with Motion-only and Safety-only connections, the Safety-only connection must be a GuardLogix 5570 or Compact GuardLogix 5370 safety controller and the Motion-only connection must be a ControlLogix 5570 or CompactLogix 5370 controller.

Motion and Safety Configuration (multi-controller)

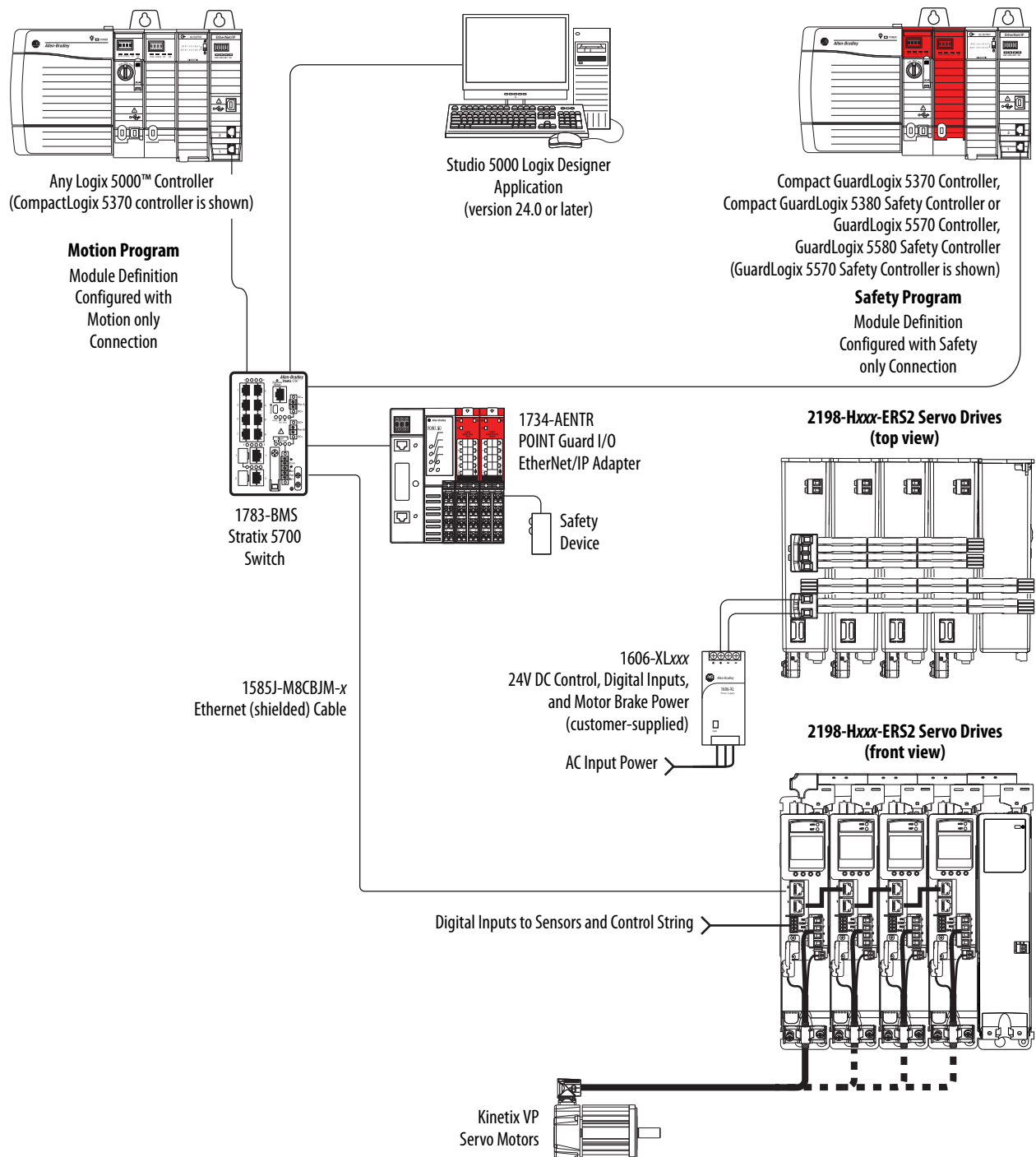

Determine What You Need

For each Kinetix 5500 drive system, the drive and motor/actuator catalog numbers are required to determine the motor cable catalog number. Ethernet cables and a 24V DC power supply are also required.

- 2198-KITCON-DSL (2-pin) connector kits are used for motor feedback from Kinetix VP motors (high-resolution absolute feedback). Kits are included with the drive and can also be purchased separately. Use these kits with 2090-CSxM1DF or 2090-CSxM1DG cables.
- 2198-H2DCK feedback converter kits (2-pin, Hiperface-to-DSL, series B or later) feedback converter kits are required for LDAT-series linear thrusters and MP-Series motors and actuators. Use these kits with 2090-CFBM7DF feedback cables.
- Shared-bus connector kits are required for shared-bus configurations.

Optional equipment includes the following:

- Kinetix 5500 capacitor module
- 2198-ABQE encoder output module
- Bulletin 2198 AC line filters
- Bulletin 2097 shunt resistors

Example diagrams of the required and optional equipment are provided.

Kinetix 5500 Servo Drives

Drive Cat. No. (hardwired STO)	Drive Cat. No. (integrated STO)	Frame	Input Voltage	Continuous Output Power kW	Continuous Output Current A 0-pk	Features
2198-H003-ERS	2198-H003-ERS2	1	195...264V rms, single-phase 195...264V rms, three-phase 324...528V rms, three-phase	0.2 kW 0.3 kW 0.6 kW	1.4	<ul style="list-style-type: none"> • Single-axis, single or three-phase • Multi-axis, three-phase bus-sharing • Designed for optimum performance with Kinetix VP servo motors • Single cable technology • Safe torque-off
2198-H008-ERS	2198-H008-ERS2			0.5 kW 0.8 kW 1.6 kW	3.5	
2198-H015-ERS	2198-H015-ERS2			1.0 kW 1.5 kW 3.2 kW	7.1	
2198-H025-ERS	2198-H025-ERS2	2	195...264V rms, three-phase 324...528V rms, three-phase	2.4 kW 5.1 kW	11.3	
2198-H040-ERS	2198-H040-ERS2			4.0 kW 8.3 kW	18.4	
2198-H070-ERS	2198-H070-ERS2			3	7.0 kW 14.6 kW	

Feedback connections are made at the 2-pin motor feedback (MF) connector. These examples illustrate how you can use the Bulletin 2198 connector kits for making these connections. These examples illustrate how you can use the Bulletin 2198 connector kits for making these connections.

Feedback Configuration Examples

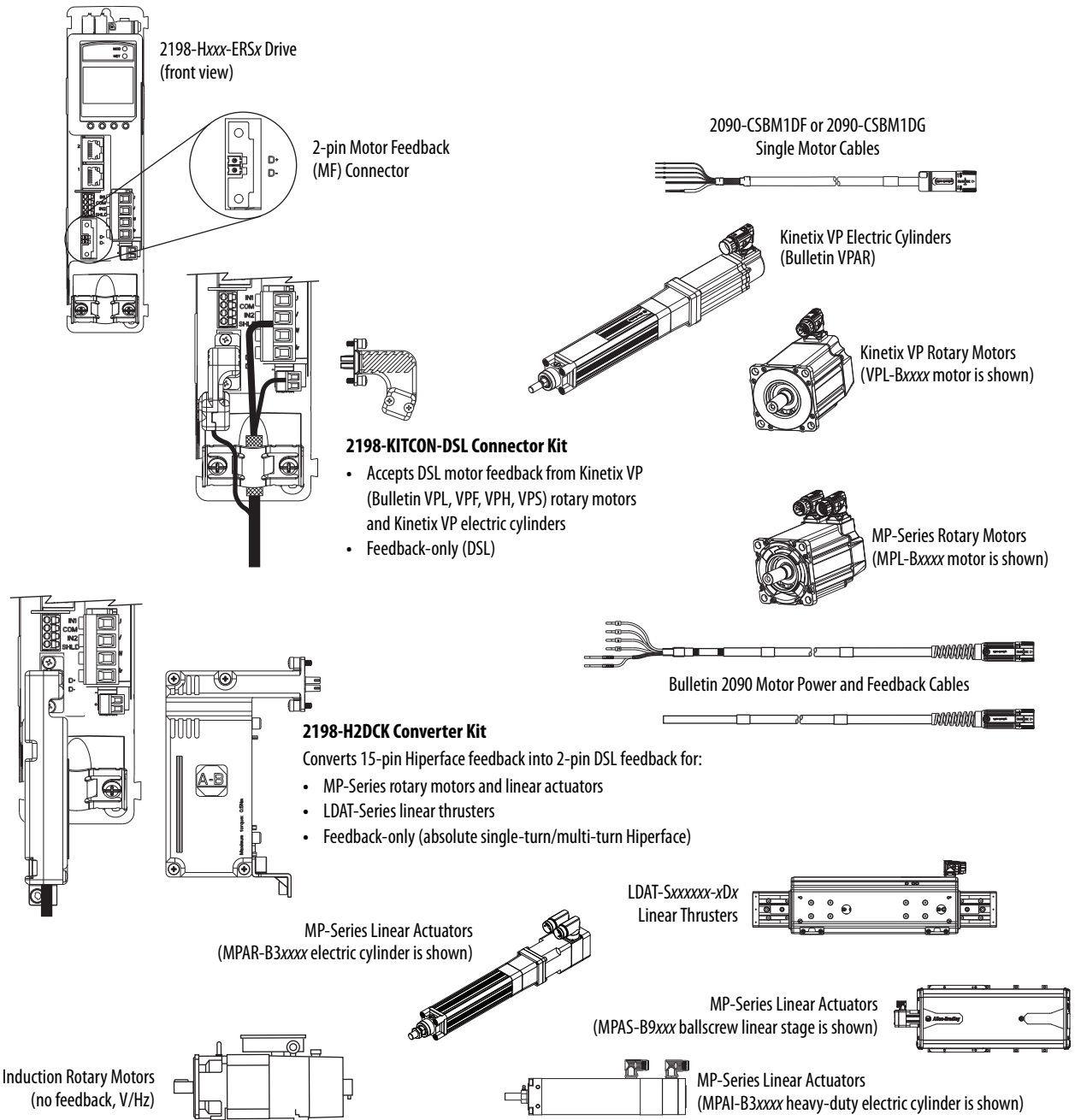

IMPORTANT In 2198-H2DCK converter kit applications, you can replace the 2090-CPxM7DF power/brake cable with a 2090-CSBM1DF single motor cable (and reuse the 2090-CFBM7DF feedback cable) to increase the maximum cable length to 50 m (164 ft). However, this applies to only 18 and 14 AWG single cables. 2090-CSxM1Dx-10Axxx (10 AWG/M40 connector) single cables are not compatible with 2090-CPBM7DF-10Axxx (10 AWG/M40 connector) power/brake cables.

Required Drive Accessories

Drive Accessory	Description	Cat. No.
24V power supply	24V DC for control power and motor brakes.	1606-XLxxx
Ethernet network cables	Double-ended, non-flex, shielded.	1585J-M8CBJM-x
	Double-ended, high-flex, shielded.	1585J-M8UBJM-x
Motor cables	Kinetix VP (Bulletin VPL, VPF, VPH, and VPS) rotary motors. ⁽¹⁾	Refer to the specific drive/motor combination for the motor cables required for your system.
	Kinetix VP (Bulletin VPAR) electric cylinders. ⁽¹⁾	
	MP-Series (Bulletin MPL, MPM, MPF, and MPS) rotary motors with high-resolution absolute encoders.	
	MP-Series (Bulletin MPAS ballscrew, MPAR, and MPAL) linear actuators.	
Shared-bus connection system	LDAT-Series linear thrusters.	
	Input wiring connectors and DC-bus T connectors for use between frame 1, 2, and 3 servo drives (frame 3:2, frame 2:1, frame 1:1, and frame 2:2). Required for shared-bus configurations.	2198-H040-x-x
Shared-bus connection system	Input wiring connectors and DC-bus T connectors for use between frame 3 servo drives (frame 3:3).	2198-H070-x-x
	HiPerface-to-DSL feedback converter kit ⁽²⁾	Converts HiPerface high-resolution absolute encoder feedback to HiPerface DSL feedback. Required for feedback connections to LDAT-Series linear thrusters and MP-Series motors and actuators.

- (1) The 2198-KITCON-DSL feedback connector kit is required for Kinetix VP motors and actuators and is included with each Kinetix 5500 servo drive. Replacement kits are also available.
- (2) The maximum cable length is reduced to 20 m (65.6 ft) for these systems and typical system performance, as documented in this publication, requires the motor and drive at 40 °C (104 °F) ambient and rated line voltage.

Kinetix 5500 Drive with Kinetix VP Motor

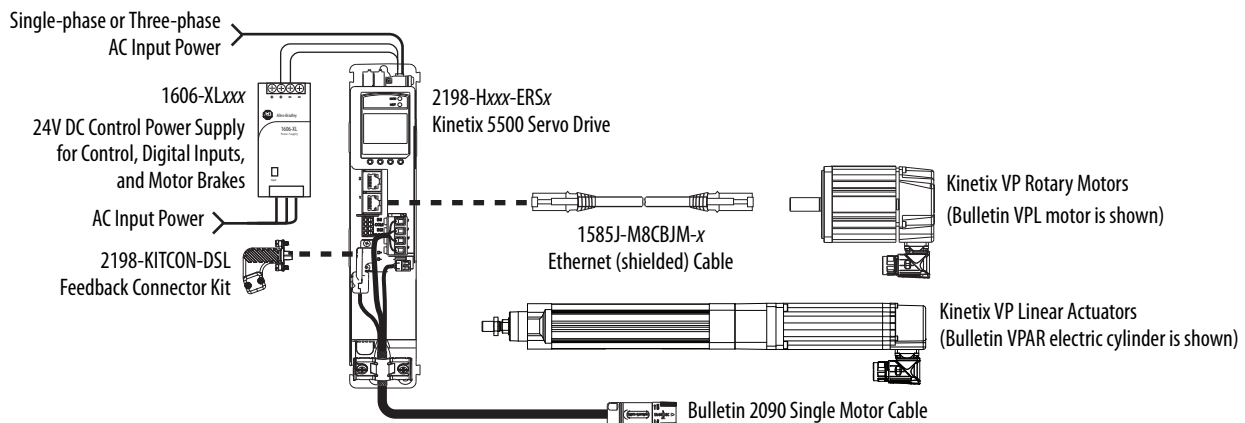

Kinetix 5500 Drive with MP-Series Motor or Actuator

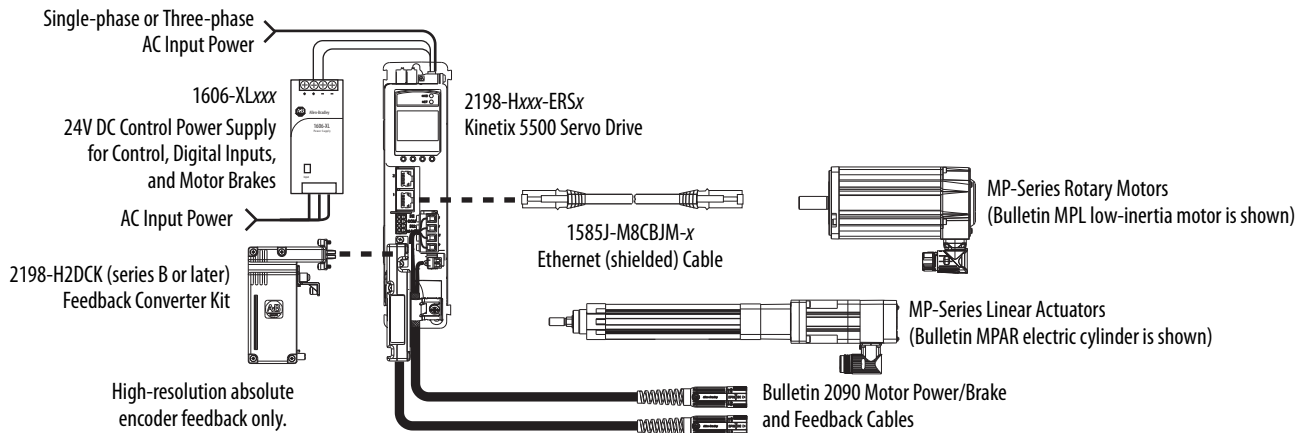

Refer to the Kinetix Servo Drives Specifications Technical Data, publication [KNX-TD003](#), for detailed descriptions and additional specifications for the Kinetix 5500 drive family.

Optional Drive Accessories

Drive Accessory	Description	Cat. No.
Shared-bus connector kits	24V input wiring connectors, T-connectors, and bus bars for the 24V shared-bus connection system	<ul style="list-style-type: none"> 2198-TCON-24VDCIN36 2198-xxxx-P-T
Capacitor module	Capacitor bank for energy storage and/or to improve performance in applications that produce regenerative energy and require shorter duty cycles (1360 µf).	2198-CAPMOD-1300
Encoder output module	The Allen-Bradley encoder output module is a DIN-rail mounted EtherNet/IP network-based standalone module capable of outputting encoder pulses to a customer-supplied peripheral device.	2198-ABQE
AC line filters	AC line conditioning for EMC.	<ul style="list-style-type: none"> 2198-DBRxx-F 2198-DBxx-F
Bulletin 2097 shunt resistor	Panel-mount shunt resistor.	2097-Rx
External auxiliary encoders	Allen-Bradley Integrated Motion encoder on the EtherNet/IP network provides a feedback-only axis.	Bulletin 842E-CM

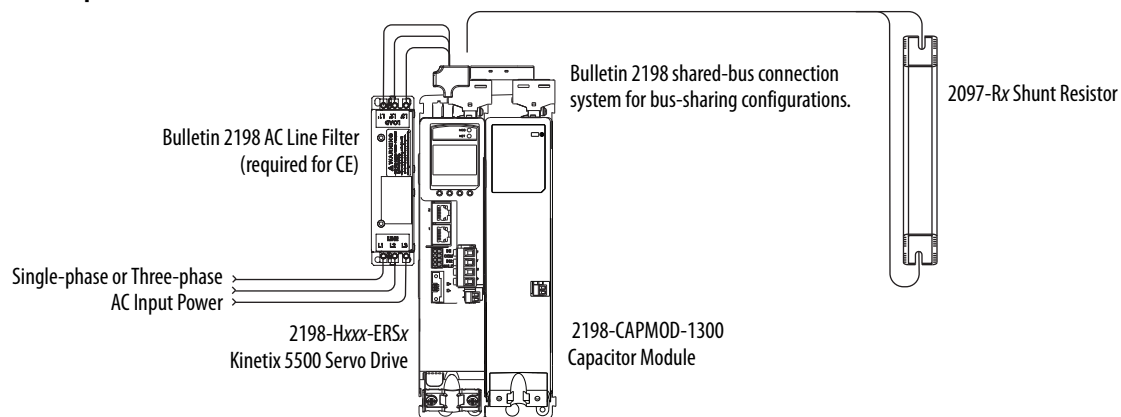
Kinetix 5500 Optional Accessories

Refer to the Kinetix Servo Drives Specifications Technical Data, publication [KNX-TD003](#), for detailed descriptions and additional specifications for the Kinetix 5500 drive accessories.

In this example, the encoder output module outputs encoder pulses to cameras used in line-scan vision systems. The module supports real and virtual axes for systems using the integrated motion on EtherNet/IP network.

Encoder Output Module Example

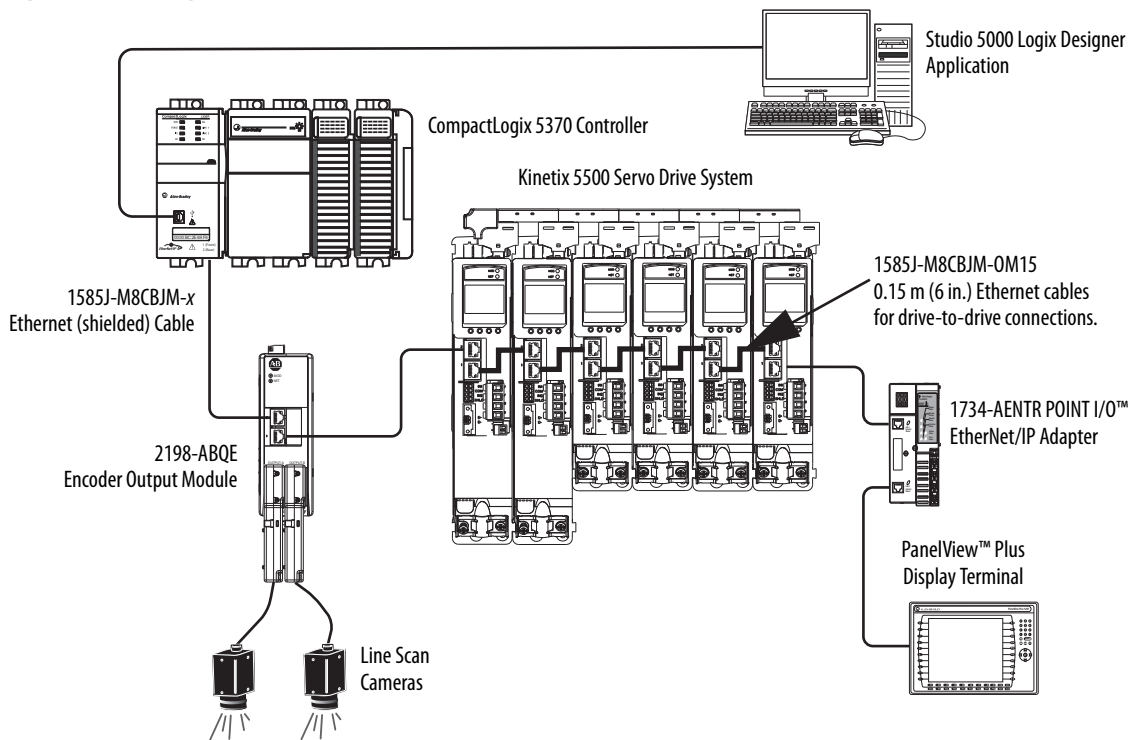

Refer to the Kinetix Servo Drives Specifications Technical Data, publication [KNX-TD003](#), for detailed descriptions and additional specifications for the Kinetix 5500 drive accessories.

Kinetix 5500 Shared-bus System Examples

These system examples illustrate how Kinetix 5500 servo drives and shared-bus accessories are used in typical shared-bus configurations. In these examples, frame 1 and 2 drives are used, so the shared-bus accessories are all catalog number 2198-H040-x-x.

Engaging the zero-stack tab and cutout from drive-to-drive makes efficient use of panel space for installations with multiple drives. Engaging the zero-stack tab and cutout from drive-to-drive is required for shared-bus multi-axis drive systems. This is done to make sure the drive connectors are spaced properly to accept the shared-bus connection system.

Zero-stack Tab and Cutout Example

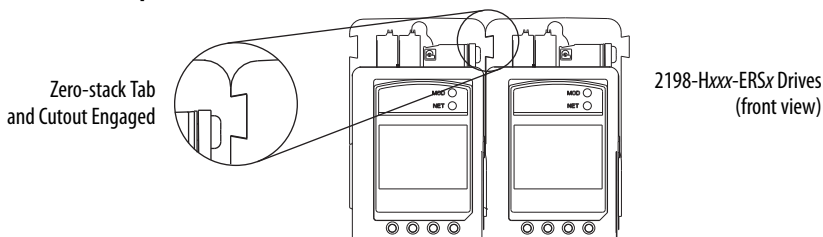

Refer to the Kinetix Servo Drives Specifications Technical Data, publication [KNX-TD003](#), for detailed descriptions and catalog numbers for the shared-bus connector kits.

In this example, three-phase AC power and 24V control power is shared in a shared-AC configuration. All drives must have the same power rating (catalog number).

Shared AC Installation Example

Kinetix 5500 Servo Drives (top view)
2198-H008-ERS (frame 1) Drives are Shown

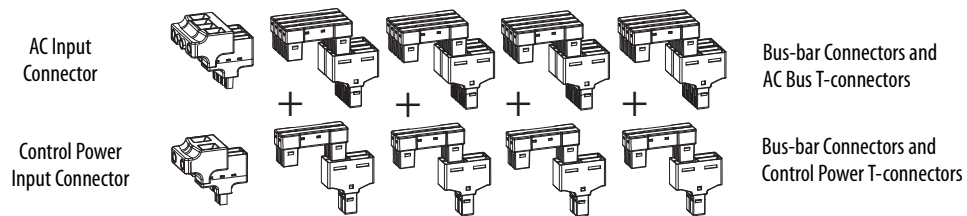
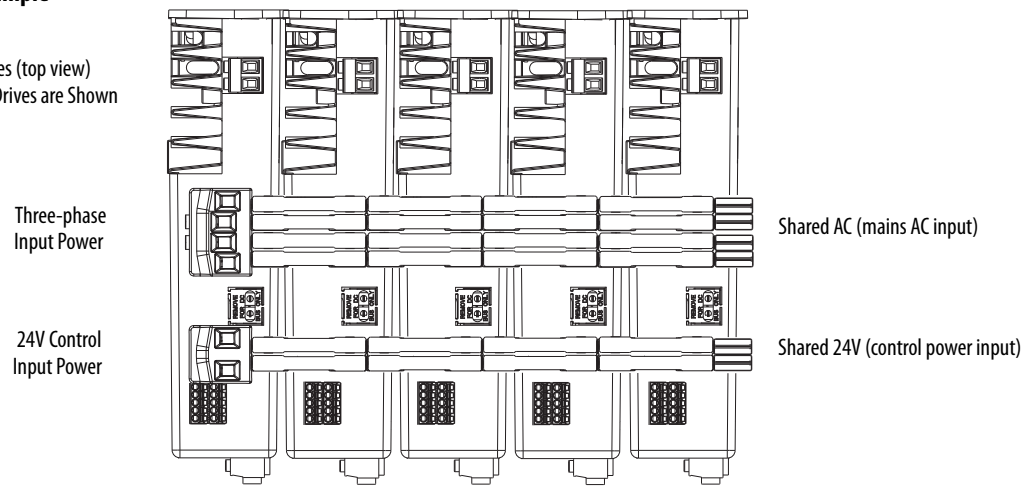

Kinetix 5500 Servo Drives (front view)
2198-H008-ERS (frame 1) Drives are Shown

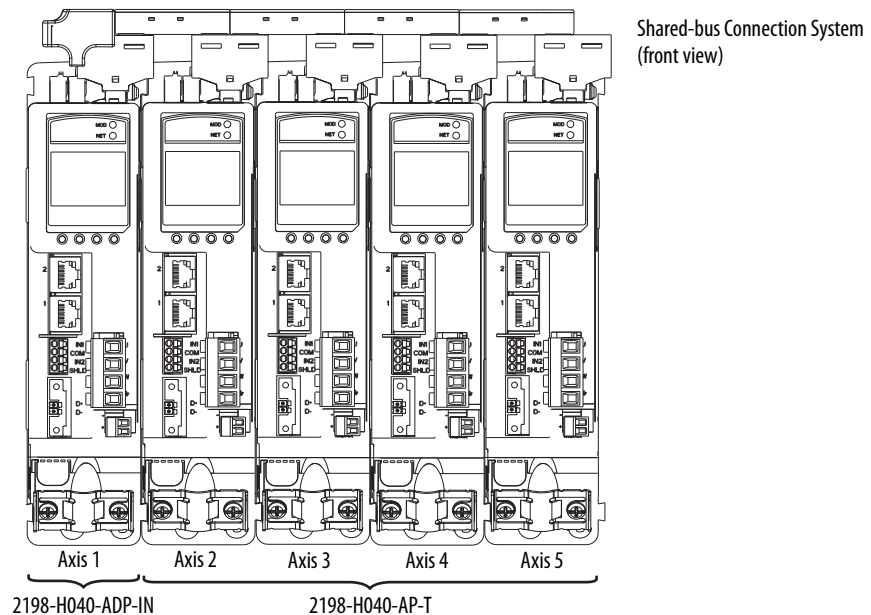

The 2198-H040-ADP-IN connector kit also includes a DC-bus T-connector, but is not used in this configuration.

IMPORTANT In shared AC configurations, all drives must have the same power rating. Shared AC configurations do not support the Bulletin 2198 capacitor module. Refer to the Kinetix 5500 Servo Drives User Manual, publication [2198-UM001](#), for system sizing information, including restrictions on how many drives can be connected in the shared AC configuration.

In this example, three-phase AC input power is supplied to two converter drives with the same power rating. This parallel converter configuration increases the DC power supplied to the inverter drives.

Shared AC/DC Bus Hybrid Installation Example

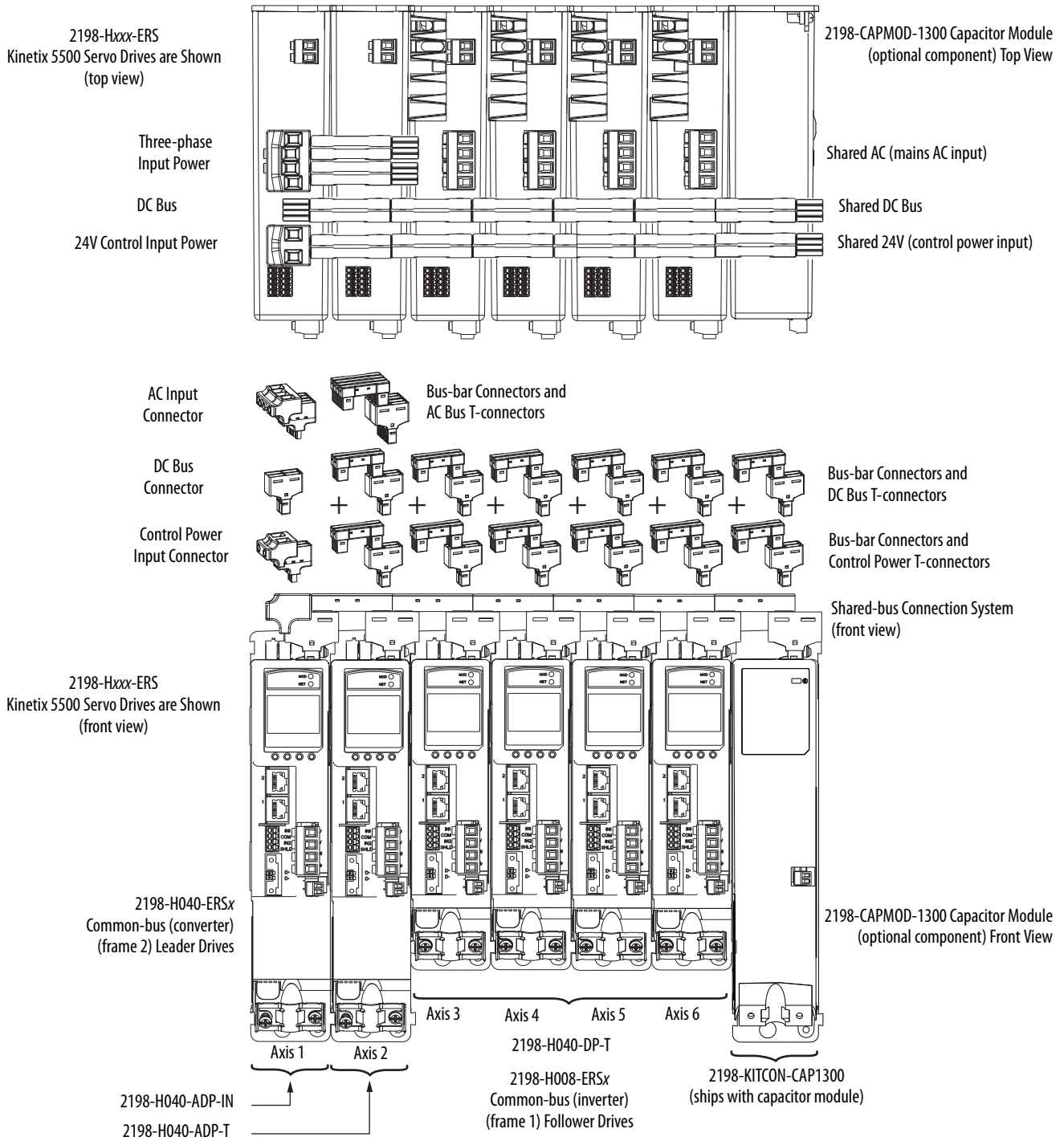

IMPORTANT In shared AC/DC hybrid configurations, the two converter drives must have the same power rating and must be greater than or equal to the inverter drives. Refer to the Kinetix 5500 Servo Drives User Manual, publication [2198-UM001](#), for system sizing information, including restrictions on how many drives can be connected in the shared AC/DC, shared DC (common bus), and hybrid configurations.

2090-Series Single Motor Cable Overview

These cables apply to Kinetix VP rotary motors and linear actuators. When using single cables, system performance of a typical system with the motor at 40 °C (104 °F) and drive at 50 °C (122 °F) ambient applies. For maximum motor-cable lengths with Kinetix 5500 drives, see the Kinetix 5500 Servo Drives User Manual, publication [2198-UM001](#).

IMPORTANT Because of the unique characteristics of single cable technology, building your own cables, using field modified Rockwell Automation® factory-delivered cable, or using third-party cables with Kinetix VP (Bulletin VPL, VPF, VPH, and VPS) motors and Bulletin VPAR electric cylinders is not an option.

2090-CSxM1DF cable conductors have flying-leads and lead preparation that is designed specifically for Kinetix 5500 servo drives. No on-site lead preparation is required. 2090-CSxM1DG cable conductors have flying-leads and lead preparation that is designed for either Kinetix 5500 or Kinetix 5700 servo drives. No on-site lead preparation is required; however, 2090-CSxM1DG cable leads are longer than 2090-CSxM1DF cable leads to accommodate either drive family.

Single Motor Cable Descriptions

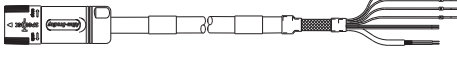
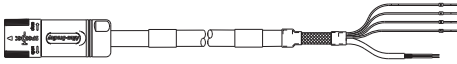
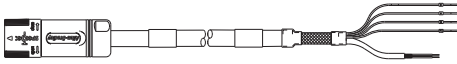
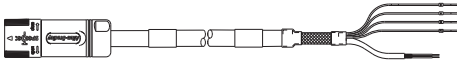
Single Cable Cat. No.	Description	Cable Configuration		Motor Connector
		Motor End	Drive End	
2090-CSBM1DF-xxAAxx 2090-CSBM1DF-xxAFxx 2090-CSBM1DG-xxAAxx 2090-CSBM1DG-xxAFxx	<ul style="list-style-type: none"> • Drive-end flying-leads (DF) (DG = longer lead lengths) • Power/feedback/brake wires (SB) • Standard, non-flex (AA) • Continuous-flex (AF) 			SpeedTec DIN
2090-CSWM1DF-xxAAxx 2090-CSWM1DG-xxAAxx	<ul style="list-style-type: none"> • Drive-end flying-leads (DF) (DG = longer lead lengths) • Power/feedback wires only (SW) 			

Single extension cables provide continuous-flex cable technology between your standard (non-flex) cable and the continuous-flex application. The IP rating for continuous-flex extension cables is consistent with the motor/actuator and cable combination they are extending. Extension cables are available in lengths up to 30 m (98.4 ft). Extension power cables are available in 18, 14, and 10 AWG.

Single Extension Cable Descriptions

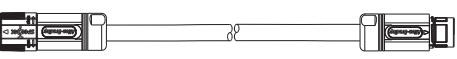
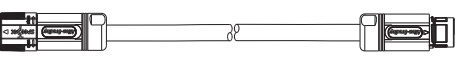
Cable Cat. No.	Description	Cable Configuration		Motor Connector
		Motor End	Drive End	
2090-CSBM1E1-xxAFxx	<ul style="list-style-type: none"> • Drive-end (male) connector, extension (E1) ⁽¹⁾ • Motor-end SpeedTec DIN cable plug (M1) 			SpeedTec DIN

(1) SpeedTec DIN connector (motor end) and male connector for extending SpeedTec DIN cable.



Refer to the Kinetix Motion Accessories Technical Data, publication [KNX-TD004](#), for cable specifications.

2090-Series Motor Power/Brake and Feedback Cables Overview

These cables apply to LDAT-Series linear thrusters and MP-Series motors and actuators with high-resolution absolute encoders. When using these cables, system performance of a typical system with the motor/actuator at 40 °C (104 °F) and drive at 40 °C (104 °F) ambient applies. Maximum motor power cable length is 20 m (65.6 ft) for Kinetix 5500 drive systems using these cables.

IMPORTANT To increase the maximum motor power cable length to 50 m (164 ft) and the system ambient to motor at 40 °C (104 °F) and drive at 50 °C (122 °F), use the 2090-CSBM1DF (single) cable for motor power/brake, and the 2090-CFBM7DF cable for motor feedback.

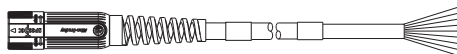
Feedback Cable Descriptions (standard, non-flex)

Standard Cable Cat. No.	Description	Cable Configuration		Motor/Actuator Connector
		Motor/Actuator End	Drive End	
2090-CFBM7DF-CEAAxx	<ul style="list-style-type: none"> Drive-end flying-leads (DF) High-resolution or resolver applications (CE) 			SpeedTec DIN (M7)
2090-CFBM4E2-CATR	<ul style="list-style-type: none"> Drive-end bayonet (E2), transition (TR) cable ⁽¹⁾ Motor-end threaded DIN (M4) All feedback types (CA) 			Threaded DIN (M4)

(1) Threaded DIN connector (motor end) and bayonet connector for 2090-XXNFMP-Sxx cable.

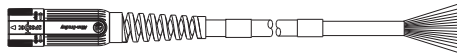
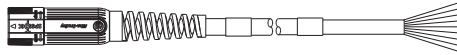
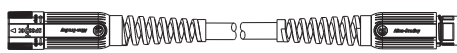

Feedback Cable Descriptions (continuous-flex)

Continuous-flex Cable Cat. No.	Description	Cable Configuration		Motor/Actuator Connector
		Motor/Actuator End	Drive End	
2090-CFBM7DF-CDAFxx	<ul style="list-style-type: none"> Drive-end flying-leads (DF) High-resolution or incremental applications (CD) 			SpeedTec DIN (M7)
2090-CFBM7DF-CEAFxx	<ul style="list-style-type: none"> Drive-end flying-leads (DF) High-resolution or resolver applications (CE) 			
2090-CFBM7E7-CDAFxx 2090-CFBM7E7-CEAFxx	<ul style="list-style-type: none"> Drive-end (male) connector, extension (E7) ⁽¹⁾ Motor-end SpeedTec DIN cable plug (M7) 			

(1) SpeedTec DIN connector (motor end) and male connector for extending SpeedTec or threaded DIN cable.

Motor-end cable connector kits, for use when building your own cables are also available. Refer to the Kinetix Motion Accessories Technical Data, publication [KNX-TD004](#), for more information.

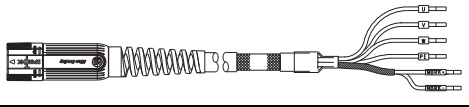
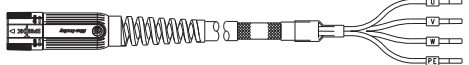
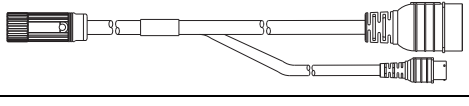
Power/Brake Cable Descriptions (standard, non-flex)

Standard Cable Cat. No.	Description	Cable Configuration		Motor/Actuator Connector
		Motor/Actuator End	Drive End	
2090-CPBM7DF-xxAAxx	<ul style="list-style-type: none"> • Drive-end flying-leads (DF) • Power/brake wires (PB) 			SpeedTec DIN (M7)
2090-CPWM7DF-xxAAxx	<ul style="list-style-type: none"> • Drive-end flying-leads (DF) • Power wires only (PW) 			
2090-CPBM4E2-xxTR	<ul style="list-style-type: none"> • Drive-end bayonet (E2), transition (TR) cable ⁽¹⁾ • Motor-end threaded DIN (M4) • Power/brake wires (PB) 			Threaded DIN (M4)
2090-CPWM4E2-xxTR	<ul style="list-style-type: none"> • Drive-end bayonet (E2), transition (TR) cable ⁽¹⁾ • Motor-end threaded DIN (M4) • Power wires only (PW) 			

(1) Threaded DIN connector (motor end) and bayonet connector for 2090-XXNFMP-5xx cable.

Power/Brake Cable Descriptions (continuous-flex)

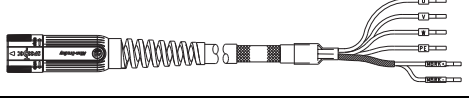
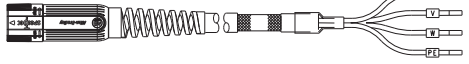
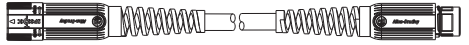
Continuous-flex Cable Cat. No.	Description	Cable Configuration		Motor/Actuator Connector
		Motor/Actuator End	Drive End	
2090-CPBM7DF-xxAFxx	<ul style="list-style-type: none"> • Drive-end flying-leads (DF) • Power/brake wires (PB) 			SpeedTec DIN (M7)
2090-CPWM7DF-xxAFxx	<ul style="list-style-type: none"> • Drive-end flying-leads (DF) • Power wires only (PW) 			
2090-CPBM7E7-xxAFxx	<ul style="list-style-type: none"> • Drive-end (male) connector, extension (E7) ⁽¹⁾ • Motor-end SpeedTec DIN cable plug (M7) 			

(1) SpeedTec DIN connector (motor end) and male connector for extending SpeedTec or threaded DIN cable.

Refer to the Kinetix Motion Accessories Technical Data, publication [KNX-TD004](#), for cable specifications.

Kinetix 5500 (200V-class operation) Drives with Kinetix VP Low Inertia Motors

This section provides system combination information for the Kinetix 5500 drives (with 200 and 240V, nominal input) when matched with Kinetix VP (200V-class) low-inertia motors. Single cable catalog numbers, system performance specifications, and the optimum torque/speed curves are included.

Kinetix 5500 servo drives are capable of 200V or 400V-class operation. These system performance tables and torque/speed curves reflect single-phase and three-phase drive operation with 200V-class motors; however, only 2198-H003-ERS x , 2198-H008-ERS x , and 2198-H015-ERS x drives are capable of single-phase operation.

Bulletin VPL Motor Cable Combinations

Rotary Motor (200V-class) Cat. No.	Single Cable Cat. No. ⁽¹⁾	Feedback Type
VPL-A063xx	2090-CSBM1Dx-18AAxx or 2090-CSWM1Dx-18AAxx (standard, non-flex) 2090-CSBM1Dx-18AFxx (continuous-flex)	Multi-turn or Single-turn Digital Encoder Feedback
VPL-A0751E, VPL-A0752C, VPL-A0753C		
VPL-A0752E, VPL-A0753E	2090-CSBM1Dx-14AAxx or 2090-CSWM1Dx-14AAxx (standard, non-flex) 2090-CSBM1Dx-14AFxx (continuous-flex)	
VPL-A1001C	2090-CSBM1Dx-18AAxx or 2090-CSWM1Dx-18AAxx (standard, non-flex) 2090-CSBM1Dx-18AFxx (continuous-flex)	
VPL-A1001M, VPL-A1002x, VPL-A1003x	2090-CSBM1Dx-14AAxx or 2090-CSWM1Dx-14AAxx (standard, non-flex) 2090-CSBM1Dx-14AFxx (continuous-flex)	
VPL-A1152x, VPL-A1153x		
VPL-A1303x, VPL-A1304x, VPL-A1306x		

(1) Use 2090-CSxM1DF or 2090-CSxM1DG cables. Cable length xx is in meters, 01 (3.3) . . . 50 (164) in 1.0 m (3.3 ft) increments. Refer to the Kinetix Motion Accessories Technical Data, publication [KNX-TD004](#), for cable specifications. For cable configuration illustrations and feature descriptions, by catalog number, refer to 2090-Series Single Motor Cable Overview beginning on [page 13](#).

Bulletin VPL Motor Performance Specifications with Kinetix 5500 (200V-class operation) Drives

Rotary Motor Cat. No.	Rated Speed rpm	Speed, max rpm	System Continuous Stall Current A 0-pk	System Continuous Stall Torque N-m (lb-in)	System Peak Stall Current A 0-pk	System Peak Stall Torque N-m (lb-in)	Motor Rated Output kW (Hp)	Kinetix 5500 Drives (240V AC Input)
VPL-A0631E	4500	4500	1.20	0.46 (4.0)	3.50	1.12 (9.91)	0.19 (0.25)	2198-H003-ERSx
					4.20	1.33 (12.0)		2198-H008-ERSx
VPL-A0631M	7200	7200	1.92	0.46 (4.0)	6.48	1.33 (12.0)	0.28 (0.38)	2198-H008-ERSx
VPL-A0632F	4800	4800	2.55	0.93 (8.0)	8.75	2.69 (24.0)	0.39 (0.52)	2198-H008-ERSx
VPL-A0633C	3000	3000	2.50	1.27 (11.0)	8.75	4.09 (36.0)	0.37 (0.50)	2198-H008-ERSx
VPL-A0633F	4500	4500	3.52	1.27 (11.0)	8.80	2.87 (25.0)	0.44 (0.59)	2198-H008-ERSx
					12.60	4.09 (36.0)		2198-H015-ERSx
VPL-A0751E	4800	4800	2.90	1.01 (9.0)	8.80	2.20 (19.0)	0.50 (0.67)	2198-H008-ERSx
					9.12	2.27 (20.0)		2198-H015-ERSx
VPL-A0752C	3300	3300	3.80	1.61 (14.0)	13.30	4.39 (39.0)	0.49 (0.66)	2198-H015-ERSx
VPL-A0752E	4800	4800	4.90	1.61 (14.0)	17.70	4.10 (36.0)	0.66 (0.88)	2198-H015-ERSx
					18.90	4.39 (39.0)		2198-H025-ERSx
VPL-A0753C	3300	3300	4.90	2.16 (19.0)	17.70	6.55 (58.0)	0.59 (0.79)	2198-H015-ERSx
					18.90	7.02 (62.0)		2198-H025-ERSx
VPL-A0753E	4600	4600	6.12	2.28 (20.0)	17.70	5.13 (45.0)	0.80 (1.07)	2198-H015-ERSx
					25.34	7.35 (65.0)		2198-H025-ERSx
VPL-A1001C	2800	2800	3.61	1.93 (17.0)	8.80	3.22 (28.0)	0.56 (0.75)	2198-H008-ERSx
					10.38	3.78 (33.0)		2198-H015-ERSx
VPL-A1001M	6500	6500	7.15	1.95 (17.0)	17.70	3.31 (29.0)	1.29 (1.73)	2198-H015-ERSx
					20.20	3.78 (33.0)		2198-H025-ERSx
VPL-A1002C	3000	3000	6.24	3.39 (30.0)	17.70	6.80 (60.0)	1.03 (1.38)	2198-H015-ERSx
					20.33	7.82 (69.0)		2198-H025-ERSx
VPL-A1002F	5000	5000	10.04	3.26 (29.0)	28.30	6.77 (60.0)	1.60 (2.14)	2198-H025-ERSx
					34.30	7.82 (69.0)		2198-H040-ERSx
VPL-A1003C	2250	2250	6.14	4.18 (37.0)	17.70	9.76 (86.0)	0.87 (1.17)	2198-H015-ERSx
					20.20	11.15 (99.0)		2198-H025-ERSx
VPL-A1003E	3750	3750	9.58	4.18 (37.0)	28.30	9.76 (86.0)	1.31 (1.76)	2198-H025-ERSx
					28.80	11.15 (99.0)		2198-H040-ERSx
VPL-A1003F	5500	5500	15.62	4.18 (37.0)	45.90	10.25 (90.0)	1.90 (2.55)	2198-H040-ERSx
					50.0	11.15 (99.0)		2198-H070-ERSx
VPL-A1152B	2150	2150	6.17	5.10 (45.0)	17.70	10.95 (96.0)	1.02 (1.37)	2198-H015-ERSx
					21.19	13.12 (116)		2198-H025-ERSx
VPL-A1152E	3300	3300	10.60	5.08 (45.0)	28.30	12.14 (107)	1.47 (1.97)	2198-H025-ERSx
					32.10	13.12 (116)		2198-H040-ERSx
VPL-A1152F	5000	5000	13.56	4.70 (42.0)	45.80	13.12 (116)	2.16 (2.90)	2198-H040-ERSx
VPL-A1153C	2300	2300	8.88	6.55 (58.0)	28.30	18.30 (162)	1.35 (1.81)	2198-H025-ERSx
					33.0	20.33 (180)		2198-H040-ERSx
VPL-A1303B	1950	1950	10.34	8.80 (78.0)	28.30	19.85 (175)	1.61 (2.16)	2198-H025-ERSx
					31.0	20.72 (183)		2198-H040-ERSx

Bulletin VPL Motor Performance Specifications with Kinetix 5500 (200V-class operation) Drives (cont.)

Rotary Motor Cat. No.	Rated Speed rpm	Speed, max rpm	System Continuous Stall Current A 0-pk	System Continuous Stall Torque N·m (lb·in)	System Peak Stall Current A 0-pk	System Peak Stall Torque N·m (lb·in)	Motor Rated Output kW (Hp)	Kinetix 5500 Drives (240V AC Input)
VPL-A1303F	4000	4000	18.60	7.75 (69.0)	45.90	15.36 (136)	2.50 (3.35)	2198-H040-ERSx
					62.0	20.72 (183)		2198-H070-ERSx
VPL-A1304A	1600	1600	9.43	10.29 (91.0)	28.30	25.03 (221)	1.55 (2.08)	2198-H025-ERSx
					33.76	28.45 (252)		2198-H040-ERSx
VPL-A1304D	3000	3000	18.40	10.20 (90.0)	45.90	21.48 (190)	2.60 (3.50)	2198-H040-ERSx
					58.0	27.10 (240)		2198-H070-ERSx
VPL-A1306C	2000	2000	14.78	13.38 (118)	45.90	28.50 (252)	2.13 (2.86)	2198-H040-ERSx
					55.83	34.62 (306)		2198-H070-ERSx

Performance specification data and curves reflect nominal system performance of a typical system with the motor at 40 °C (104 °F) and the drive at 50 °C (122 °F) ambient, and rated line voltage. For additional information on ambient and line conditions, refer to Motion Analyzer software.

Kinetix 5500 (200V-class operation) Drives/Kinetix VP Low Inertia Motor Curves

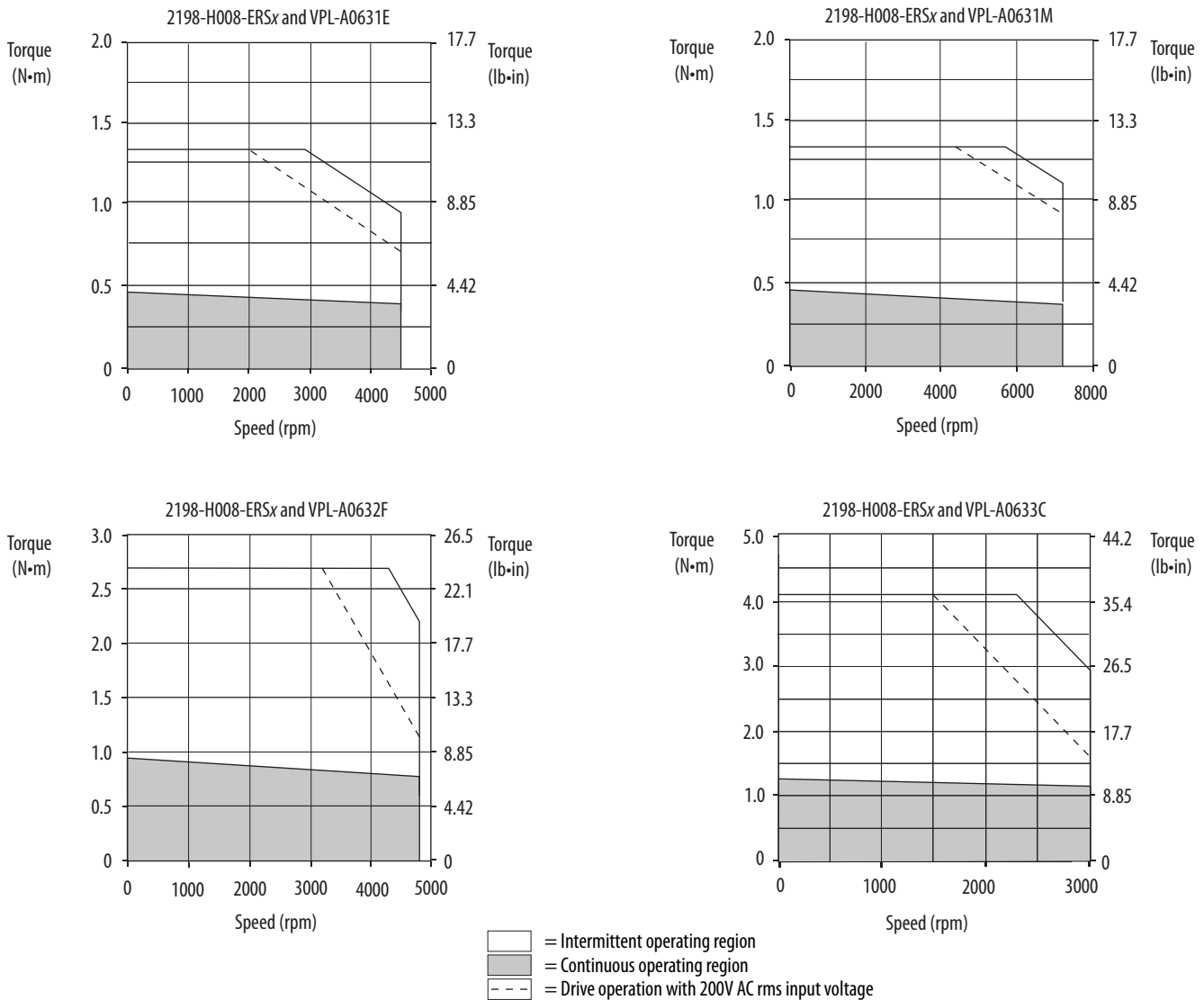

Kinetix 5500 (200V-class operation) Drives/Kinetix VP Low Inertia Motor Curves (continued)

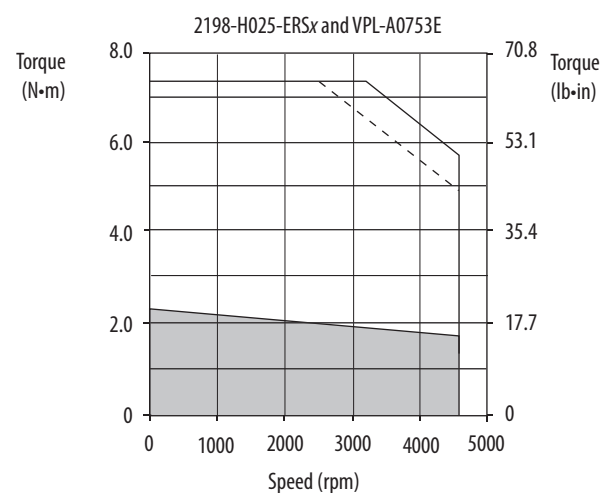
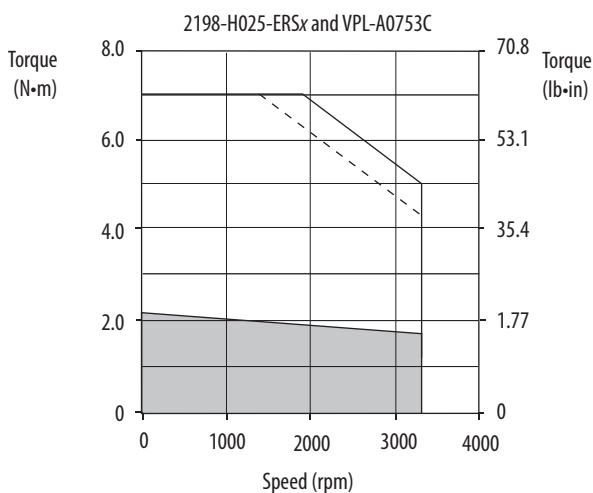
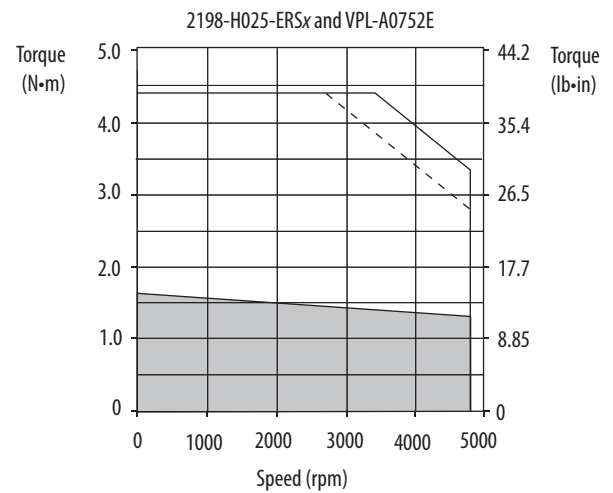
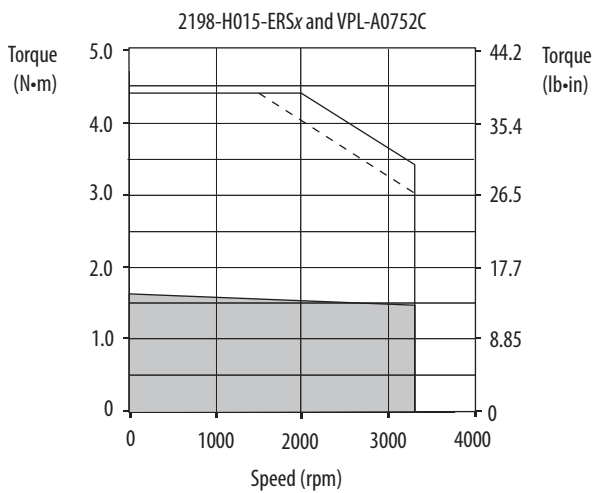
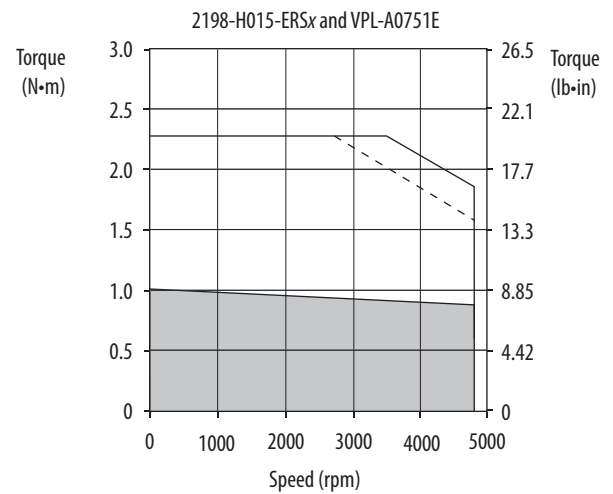
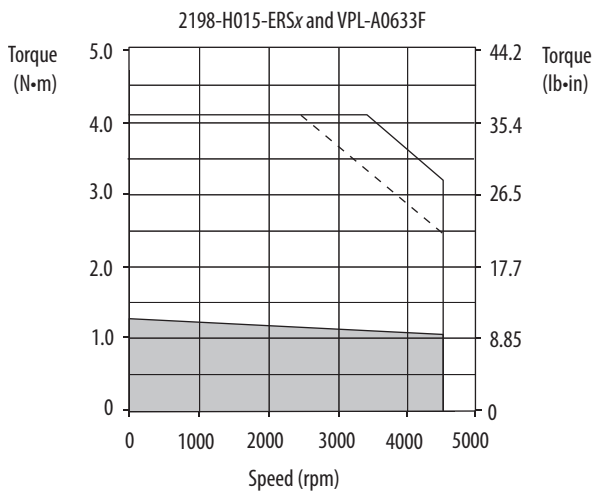

- = Intermittent operating region
- = Continuous operating region
- = Drive operation with 200V AC rms input voltage

Kinetix 5500 (200V-class operation) Drives/Kinetix VP Low Inertia Motor Curves (continued)

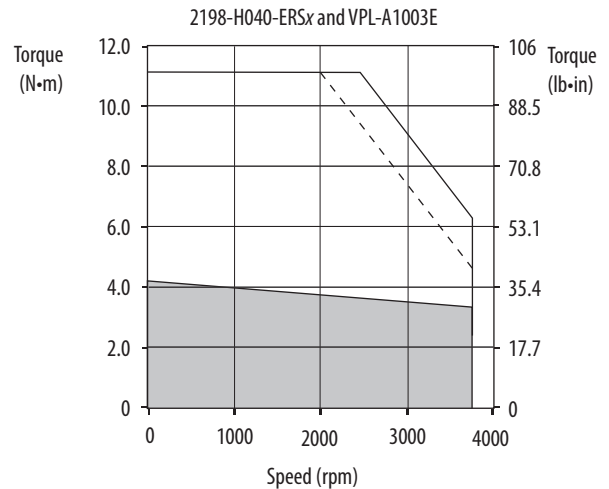
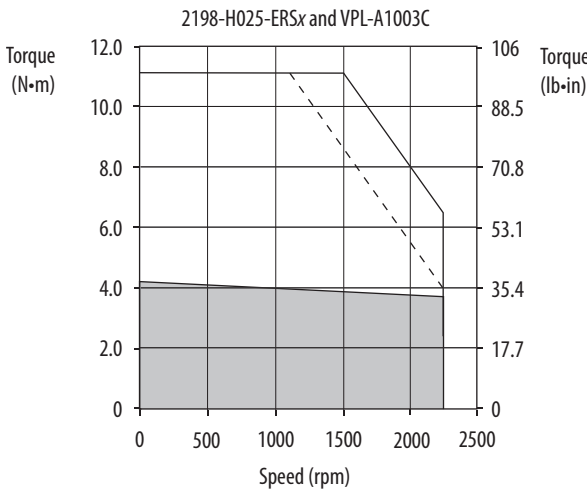
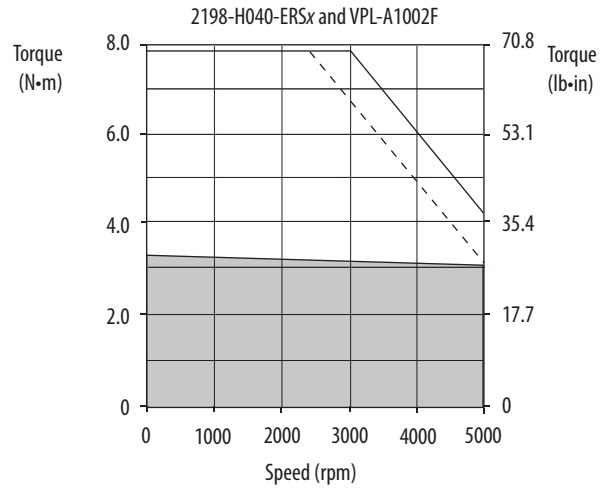
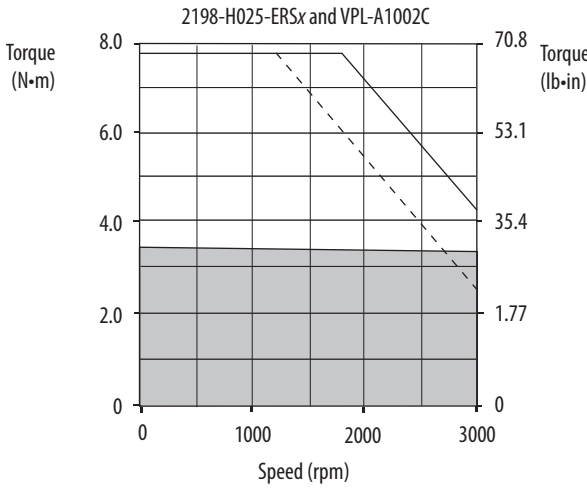
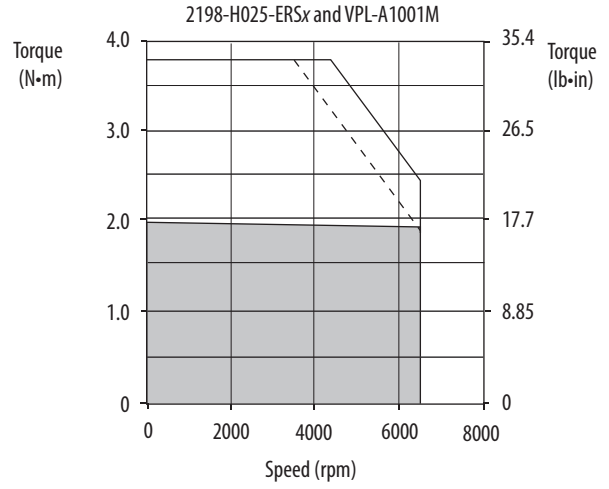
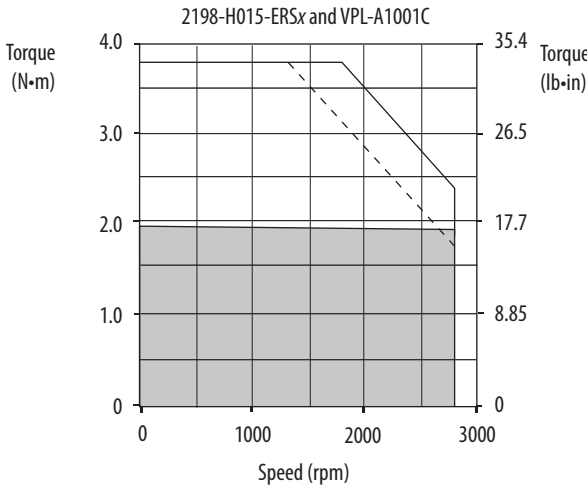

- = Intermittent operating region
- = Continuous operating region
- = Drive operation with 200V AC rms input voltage

Kinetix 5500 (200V-class operation) Drives/Kinetix VP Low Inertia Motor Curves (continued)

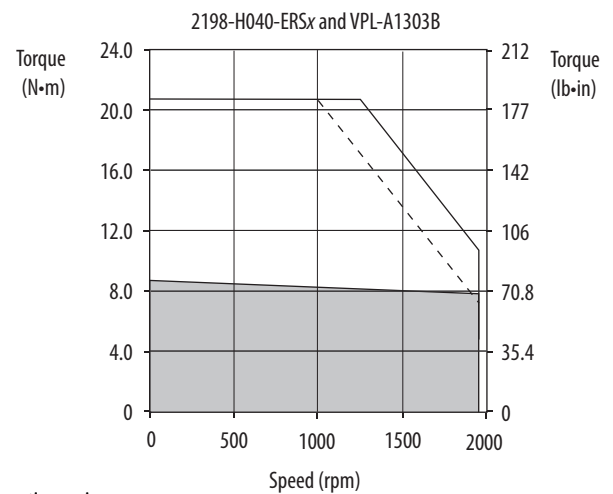
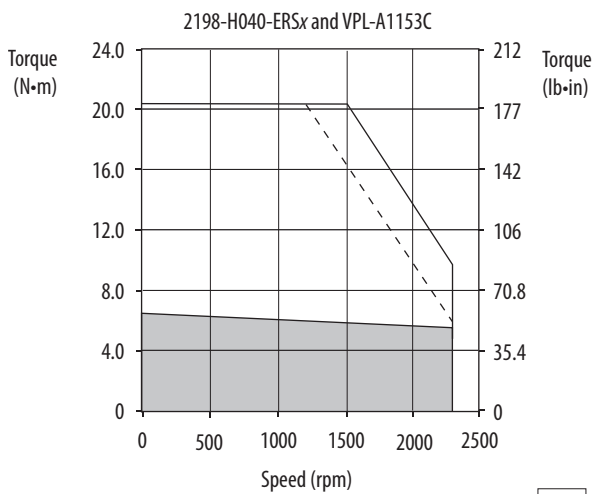
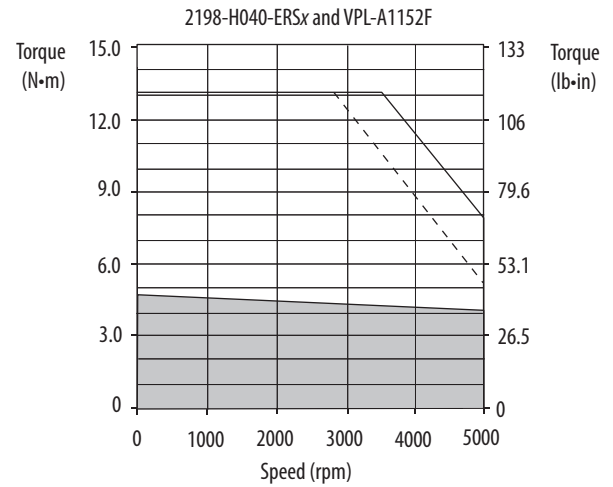
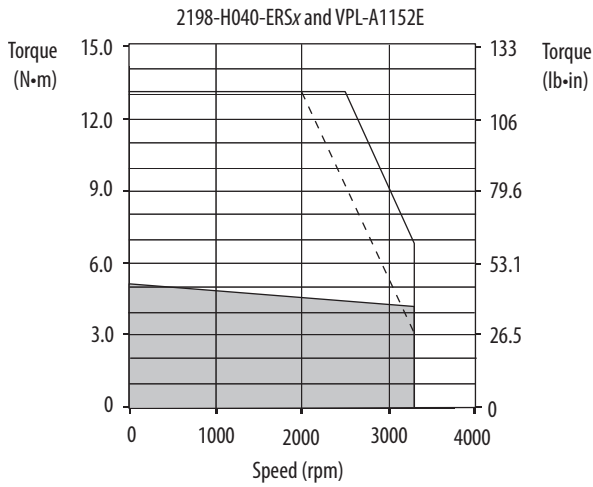
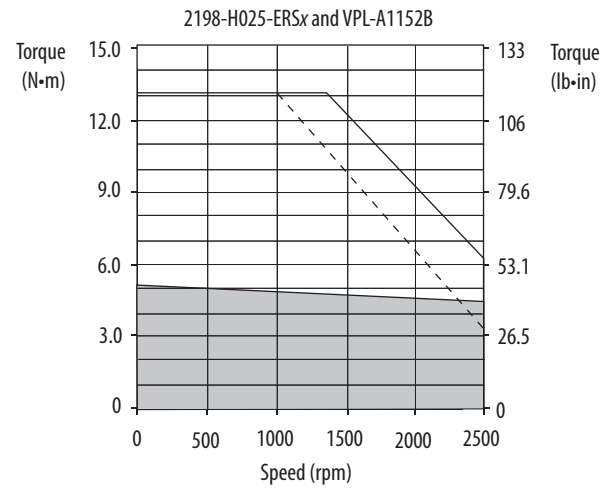
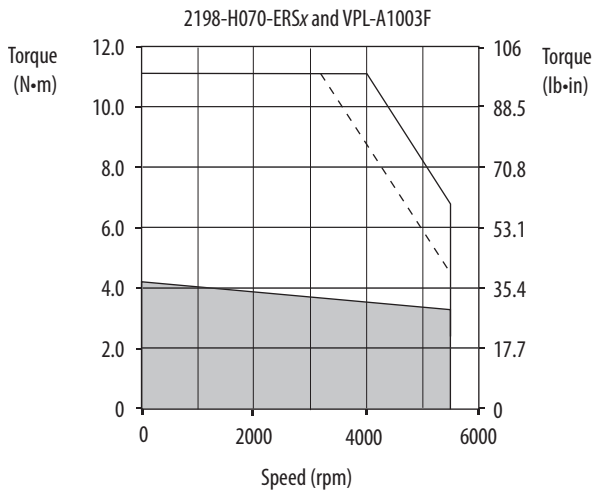

- = Intermittent operating region
- = Continuous operating region
- = Drive operation with 200V AC rms input voltage

Kinetix 5500 (200V-class operation) Drives/Kinetix VP Low Inertia Motor Curves (continued)

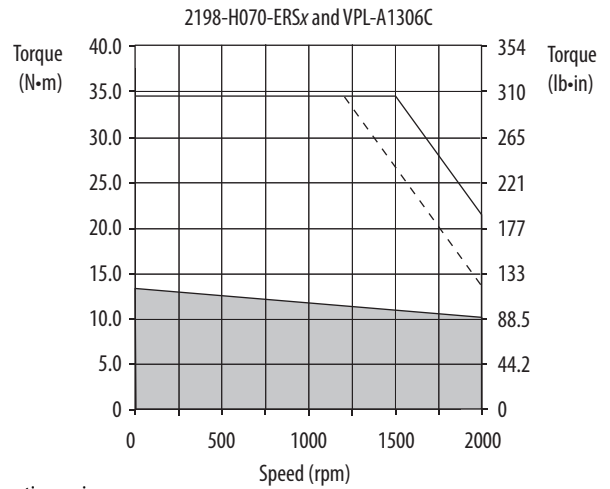
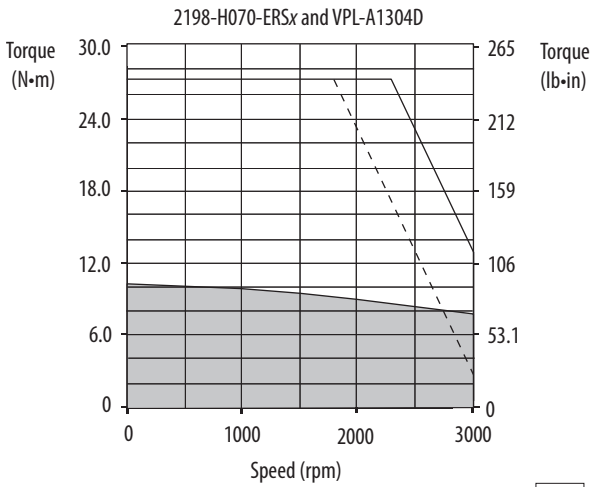
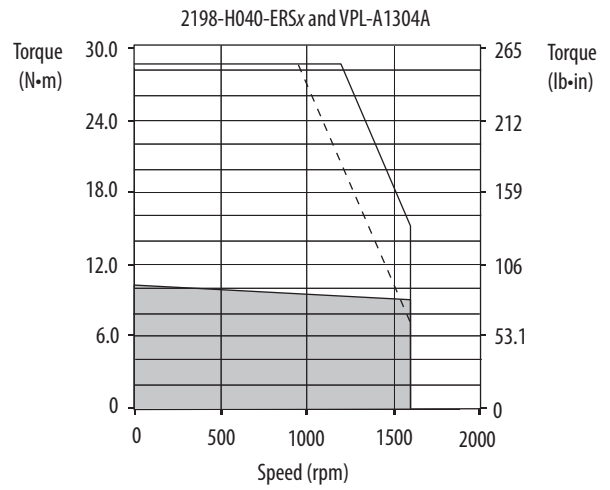
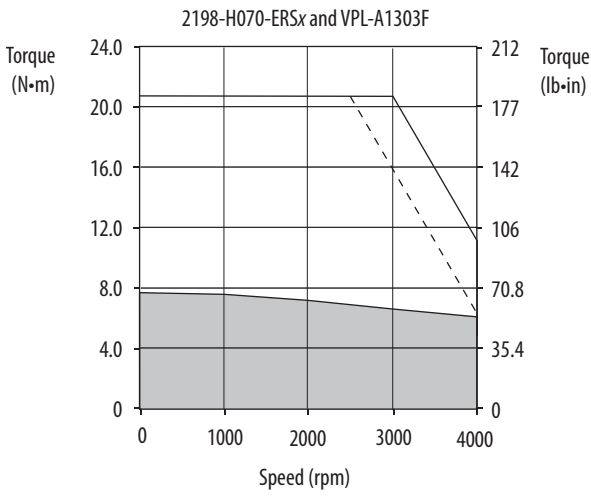

- = Intermittent operating region
- = Continuous operating region
- = Drive operation with 200V AC rms input voltage

Kinetix 5500 (400V-class operation) Drives with Kinetix VP Low Inertia Motors

This section provides system combination information for the Kinetix 5500 drives (with 400 and 480V, nominal input) when matched with Kinetix VP (400V-class) low-inertia motors. Single cable catalog numbers, system performance specifications, and the optimum torque/speed curves are included.

Bulletin VPL Motor Cable Combinations

Rotary Motor (400V-class) Cat. No.	Single Cable Cat. No. ⁽¹⁾	Feedback Type
VPL-B063xx	2090-CSBM1Dx-18AAxx or 2090-CSWM1Dx-18AAxx (standard, non-flex) 2090-CSBM1Dx-18AFxx (continuous-flex)	Multi-turn or Single-turn Digital Encoder Feedback
VPL-B0751M, VPL-B0752E, VPL-B0752F, VPL-B0753E, VPL-B0753F		
VPL-B1001M, VPL-B1002E, VPL-B1003C	2090-CSBM1Dx-14AAxx or 2090-CSWM1Dx-14AAxx (standard, non-flex) 2090-CSBM1Dx-14AFxx (continuous-flex)	
VPL-B0752M, VPL-B0753M		
VPL-B1002M, VPL-B1003F, VPL-B1003T	2090-CSBM1Dx-18AAxx or 2090-CSWM1Dx-18AAxx (standard, non-flex) 2090-CSBM1Dx-18AFxx (continuous-flex)	
VPL-B1152C		
VPL-B1152F, VPL-B1152T, VPL-B1153E, VPL-B1153F	2090-CSBM1Dx-14AAxx or 2090-CSWM1Dx-14AAxx (standard, non-flex) 2090-CSBM1Dx-14AFxx (continuous-flex)	
VPL-B1303x, VPL-B1304x, VPL-B1306x		
VPL-B1651C, VPL-B1651F, VPL-B1652C, VPL-B1652F, VPL-B1653C, VPL-B1653D, VPL-B1654B	2090-CSBM1Dx-10AFxx (continuous-flex)	
VPL-B1654D		

(1) Use 2090-CSxM1DF or 2090-CSxM1DG cables. Cable length xx is in meters, 01 (3.3) . . . 50 (164) in 1.0 m (3.3 ft) increments. Refer to the Kinetix Motion Accessories Technical Data, publication [KNX-TD004](#), for cable specifications. For cable configuration illustrations and feature descriptions, by catalog number, refer to 2090-Series Single Motor Cable Overview beginning on [page 13](#).

Bulletin VPL Motor Performance Specifications with Kinetix 5500 (400V-class operation) Drives

Motor Cat. No.	Rated Speed rpm	Speed, max rpm	System Continuous Stall Current A (0-pk)	System Continuous Stall Torque N·m (lb·in)	System Peak Stall Current A 0-pk	System Peak Stall Torque N·m (lb·in)	Motor Rated Output kW (Hp)	Kinetix 5500 Drives (480V AC input)
VPL-B0631T	8000	8000	1.20	0.46 (4.0)	3.50	1.12 (10.0)	0.31 (0.42)	2198-H003-ERSx
					4.20	1.33 (12.0)		2198-H008-ERSx
VPL-B0631U	8000	8000	1.92	0.46 (4.0)	6.48	1.33 (12.0)	0.31 (0.42)	2198-H008-ERSx
VPL-B0632F	4600	4600	1.20	0.93 (8.0)	3.50	2.26 (20.0)	0.37 (0.50)	2198-H003-ERSx
					4.20	2.69 (24.0)		2198-H008-ERSx
VPL-B0632T	8000	8000	2.55	0.93 (8.0)	8.75	2.69 (24.0)	0.54 (0.72)	2198-H008-ERSx
VPL-B0633M	6500	6700	2.50	1.27 (11.0)	8.75	4.09 (36.0)	0.57 (0.76)	2198-H008-ERSx
VPL-B0633T	6500	8000	3.52	1.27 (11.0)	8.80	2.87 (25.0)	0.57 (0.76)	2198-H008-ERSx
					12.60	4.09 (36.0)		2198-H015-ERSx
VPL-B0751M	8000	8000	2.90	1.01 (9.0)	8.80	2.20 (19.0)	0.54 (0.72)	2198-H008-ERSx
					9.12	2.27 (20.0)		2198-H015-ERSx
VPL-B0752E	4900	4900	2.70	1.61 (14.0)	8.80	4.10 (36.0)	0.67 (0.90)	2198-H008-ERSx
					9.45	4.39 (39.0)		2198-H015-ERSx
VPL-B0752F	7000	7000	3.80	1.61 (14.0)	13.30	4.39 (39.0)	0.80 (1.07)	2198-H015-ERSx
VPL-B0752M	8000	8000	4.90	1.61 (14.0)	17.70	4.10 (36.0)	0.81 (1.09)	2198-H015-ERSx
					18.90	4.39 (39.0)		2198-H025-ERSx
VPL-B0753E	4500	4500	3.80	2.28 (20.0)	13.30	7.35 (65.0)	0.81 (1.09)	2198-H015-ERSx

Bulletin VPL Motor Performance Specifications with Kinetix 5500 (400V-class operation) Drives (cont.)

Motor Cat. No.	Rated Speed rpm	Speed, max rpm	System Continuous Stall Current A (0-pk)	System Continuous Stall Torque N·m (lb·in)	System Peak Stall Current A 0-pk	System Peak Stall Torque N·m (lb·in)	Motor Rated Output kW (Hp)	Kinetix 5500 Drives (480V AC input)
VPL-B0753F	4500	6600	4.09	2.16 (19.0)	17.70	6.55 (58.0)	0.65 (0.87)	2198-H015-ERSx
					18.90	7.02 (62.0)		2198-H025-ERSx
VPL-B0753M	6000	8000	6.12	2.28 (20.0)	17.70	5.13 (45.0)	0.82 (1.10)	2198-H015-ERSx
					25.34	7.35 (65.0)		2198-H025-ERSx
VPL-B1001M	6000	6000	3.61	1.93 (17.0)	8.80	3.22 (28.0)	1.14 (1.53)	2198-H008-ERSx
					10.38	3.78 (33.0)		2198-H015-ERSx
VPL-B1002E	3300	3300	3.44	3.39 (30.0)	8.80	6.47 (57.0)	1.12 (1.50)	2198-H008-ERSx
					10.69	7.82 (69.0)		2198-H015-ERSx
VPL-B1002M	6000	6000	6.24	3.39 (30.0)	17.70	6.80 (60.0)	1.86 (2.49)	2198-H015-ERSx
					20.33	7.82 (69.0)		2198-H025-ERSx
VPL-B1003C	2500	2500	3.41	4.18 (37.0)	8.80	9.29 (82.0)	0.96 (1.29)	2198-H008-ERSx
					10.61	11.15 (99.0)		2198-H015-ERSx
VPL-B1003F	4750	4750	6.14	4.18 (37.0)	17.70	9.76 (86.0)	1.65 (2.21)	2198-H015-ERSx
					20.20	11.15 (99.0)		2198-H025-ERSx
VPL-B1003T	7000	7000	9.58	4.18 (37.0)	28.30	9.76 (86.0)	1.77 (2.37)	2198-H025-ERSx
					28.80	11.15 (99.0)		2198-H040-ERSx
VPL-B1152C	2250	2250	3.13	5.10 (45.0)	8.80	10.80 (95.0)	1.06 (1.42)	2198-H008-ERSx
					10.74	13.12 (116)		2198-H015-ERSx
VPL-B1152F	4000	4500	6.17	5.10 (45.0)	17.70	10.95 (97.0)	1.40 (1.88)	2198-H015-ERSx
					21.19	13.12 (116)		2198-H025-ERSx
VPL-B1152T	6500	6500	10.81	5.08 (45.0)	28.30	12.14 (107)	2.29 (3.07)	2198-H025-ERSx
					32.10	13.12 (116)		2198-H040-ERSx
VPL-B1153E	3200	3200	6.13	6.55 (58.0)	17.70	16.85 (149)	1.75 (2.35)	2198-H015-ERSx
					21.33	20.33 (180)		2198-H025-ERSx
VPL-B1153F	5000	5000	8.88	6.55 (58.0)	28.30	18.30 (162)	2.30 (3.08)	2198-H025-ERSx
					33.0	20.33 (180)		2198-H040-ERSx
VPL-B1303C	2250	2250	6.30	8.80 (78.0)	17.70	19.83 (175)	1.83 (2.45)	2198-H015-ERSx
					18.47	20.72 (183)		2198-H025-ERSx
VPL-B1303F	4000	4000	10.10	8.80 (78.0)	28.30	19.85 (175)	2.82 (3.78)	2198-H025-ERSx
					31.0	20.72 (183)		2198-H040-ERSx
VPL-B1304C	2150	2150	7.0	10.29 (91.0)	17.70	22.55 (199)	1.75 (2.35)	2198-H015-ERSx
					22.3	28.45 (252)		2198-H025-ERSx
VPL-B1304E	3500	3500	9.44	10.29 (91.0)	28.30	25.03 (221)	2.82 (3.78)	2198-H025-ERSx
					33.76	28.45 (252)		2198-H040-ERSx
VPL-B1306C	2500	2500	10.80	13.38 (118)	28.30	31.21 (276)	2.46 (3.30)	2198-H025-ERSx
					32.94	34.62 (306)		2198-H040-ERSx
VPL-B1306F	4250	4250	14.78	13.38 (118)	45.90	28.50 (252)	2.95 (3.95)	2198-H040-ERSx
					55.83	34.62 (306)		2198-H070-ERSx
VPL-B1651C	2750	2750	10.21	11.50 (102)	28.30	21.68 (192)	2.32 (3.11)	2198-H025-ERSx
					29.29	22.45 (199)		2198-H040-ERSx
VPL-B1651F	4750	4750	17.60	11.43 (101)	45.90	18.02 (159)	4.38 (5.87)	2198-H040-ERSx
					57.27	22.45 (199)		2198-H070-ERSx

Bulletin VPL Motor Performance Specifications with Kinetix 5500 (400V-class operation) Drives (cont.)

Motor Cat. No.	Rated Speed rpm	Speed, max rpm	System Continuous Stall Current A (0-pk)	System Continuous Stall Torque N·m (lb·in)	System Peak Stall Current A 0-pk	System Peak Stall Torque N·m (lb·in)	Motor Rated Output kW (Hp)	Kinetix 5500 Drives (480V AC input)
VPL-B1652C	2700	2700	16.0	19.40 (172)	45.90	44.78 (396)	4.18 (5.60)	2198-H040-ERSx
					49.88	48.60 (430)		
VPL-B1652F	4000	4000	18.60	17.60 (156)	60.00	48.60 (430)	4.77 (6.40)	2198-H070-ERSx
VPL-B1653C	2300	2300	17.75	25.76 (228)	45.90	55.14 (488)	4.38 (5.87)	2198-H040-ERSx
					55.60	66.70 (590)		2198-H070-ERSx
VPL-B1653D	3000	3000	18.60	24.20 (214)	68.00	67.80 (600)	5.50 (7.30)	2198-H070-ERSx
VPL-B1654B	1850	1850	15.54	32.97 (292)	45.90	65.38 (578)	5.55 (7.44)	2198-H040-ERSx
					55.75	79.30 (702)		2198-H070-ERSx
VPL-B1654D	3000	3000	24.47	32.0 (283)	81.30	75.30 (666)	7.16 (9.60)	2198-H070-ERSx

Performance specification data and curves reflect nominal system performance of a typical system with the motor at 40 °C (104 °F) and the drive at 50 °C (122 °F) ambient, and rated line voltage. For additional information on ambient and line conditions, refer to Motion Analyzer software.

Kinetix 5500 (400V-class operation) Drives/Kinetix VP Low Inertia Motor Curves

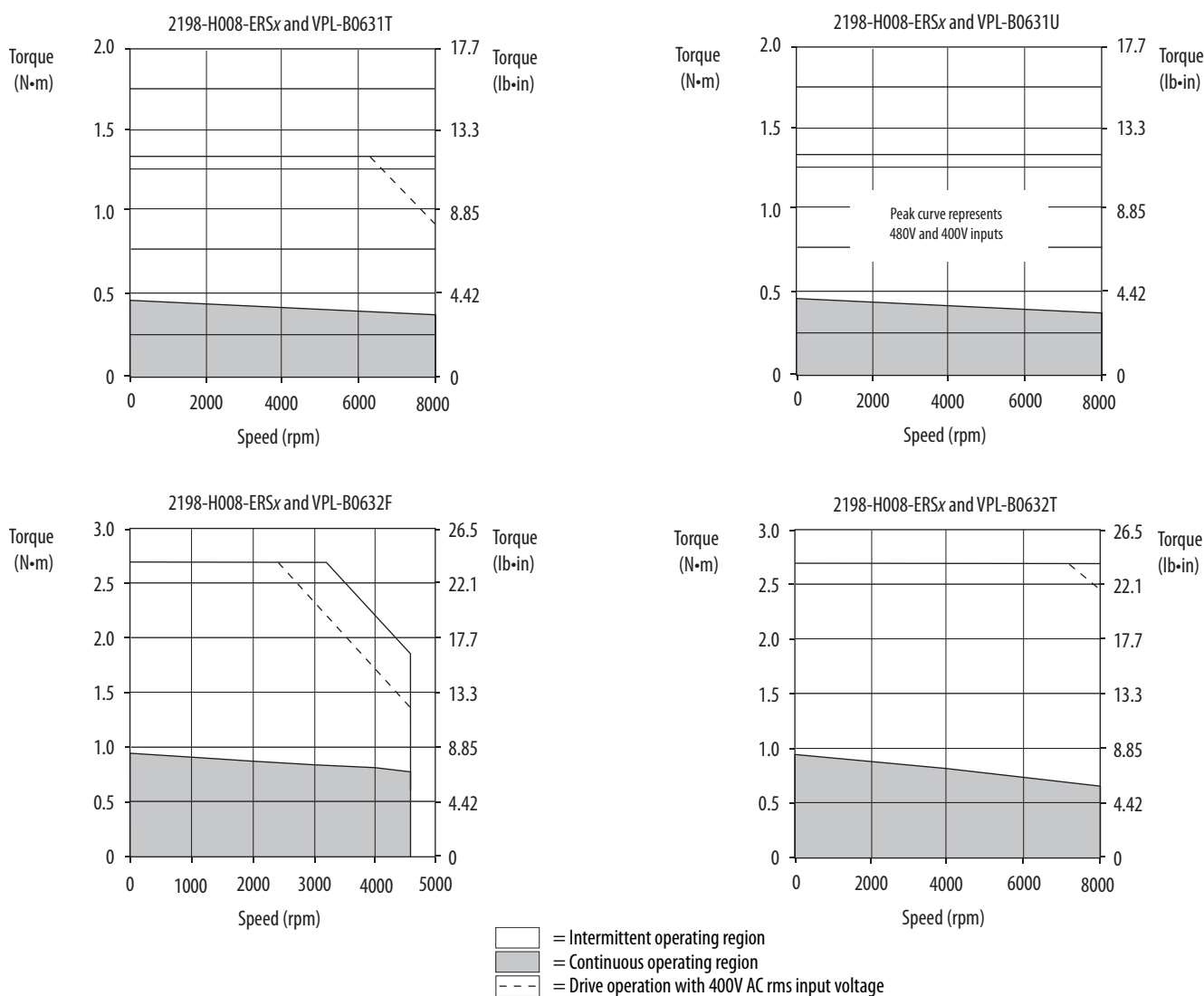

Kinetix 5500 (400V-class operation) Drives/Kinetix VP Low Inertia Motor Curves (continued)

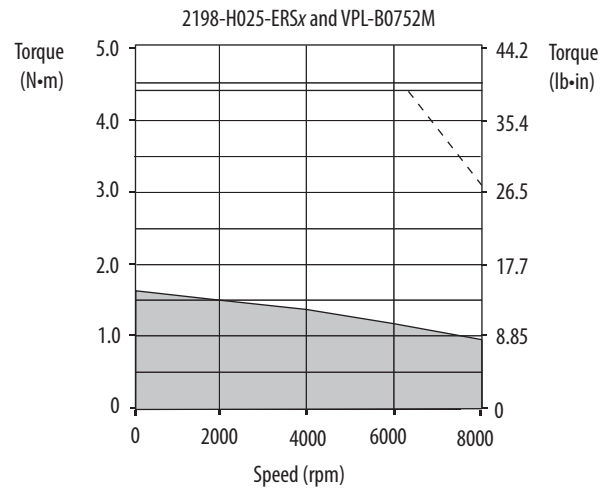
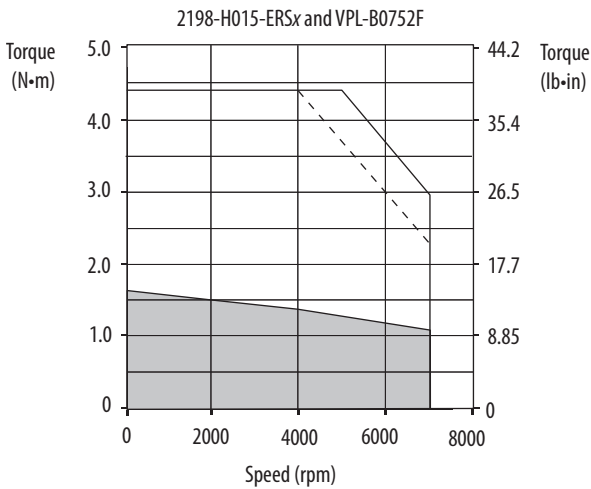
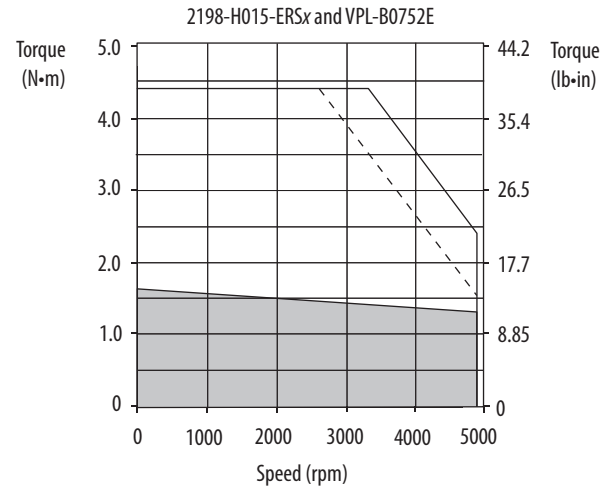
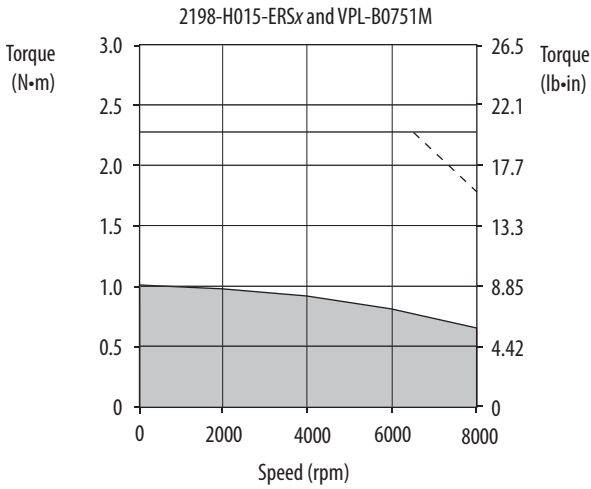
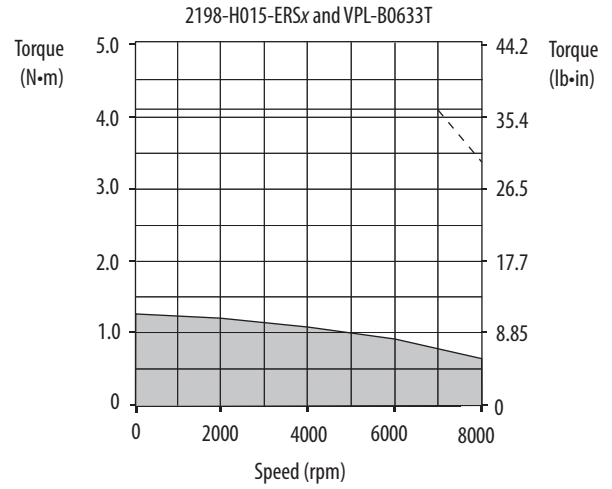
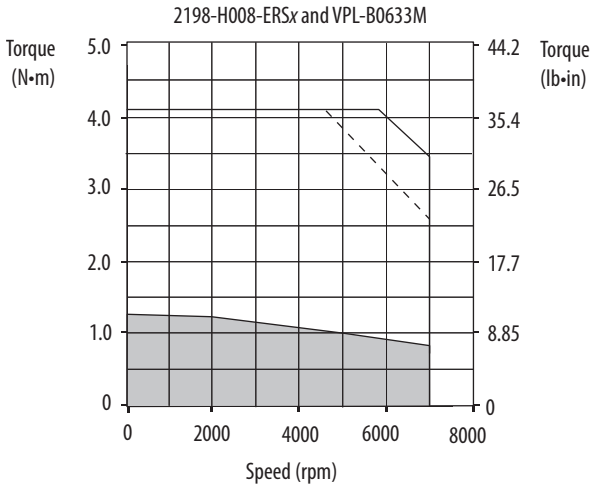

- = Intermittent operating region
- = Continuous operating region
- = Drive operation with 400V AC rms input voltage

Kinetix 5500 (400V-class operation) Drives/Kinetix VP Low Inertia Motor Curves (continued)

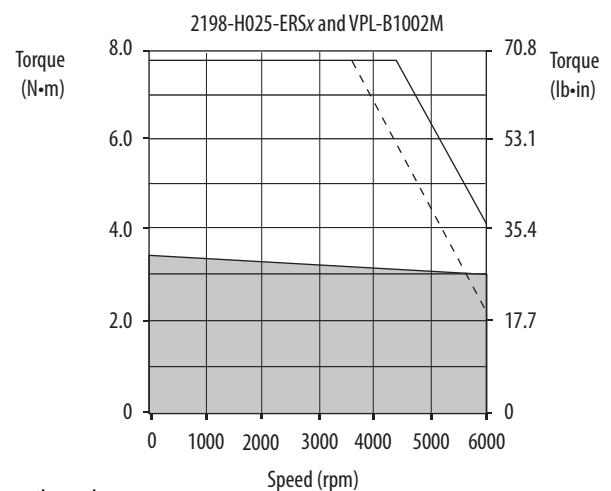
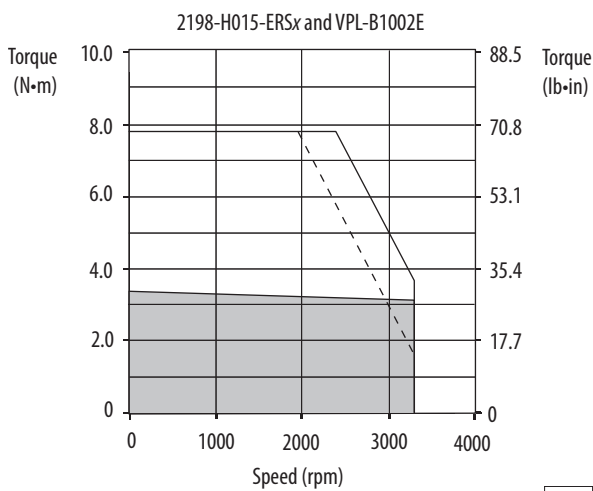
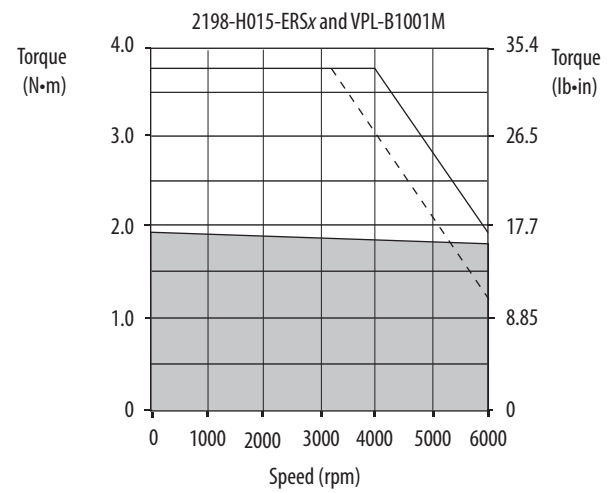
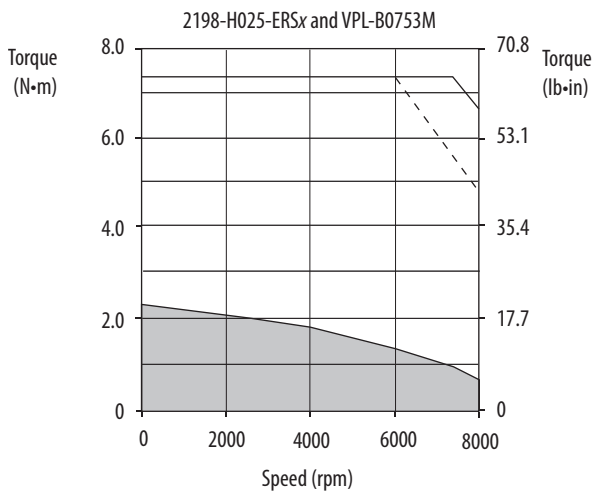
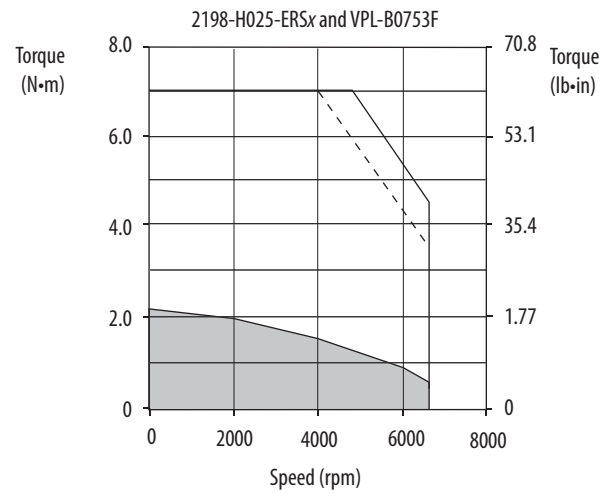
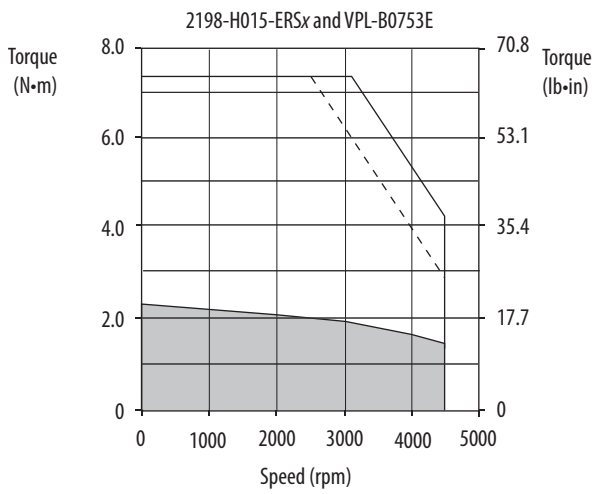

- = Intermittent operating region
- = Continuous operating region
- = Drive operation with 400V AC rms input voltage

Kinetix 5500 (400V-class operation) Drives/Kinetix VP Low Inertia Motor Curves (continued)

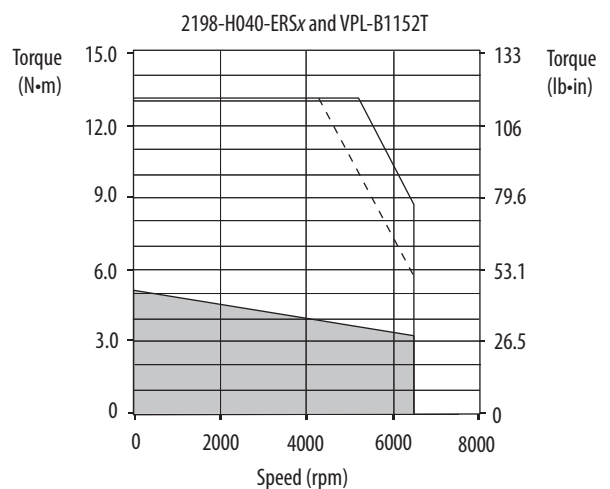
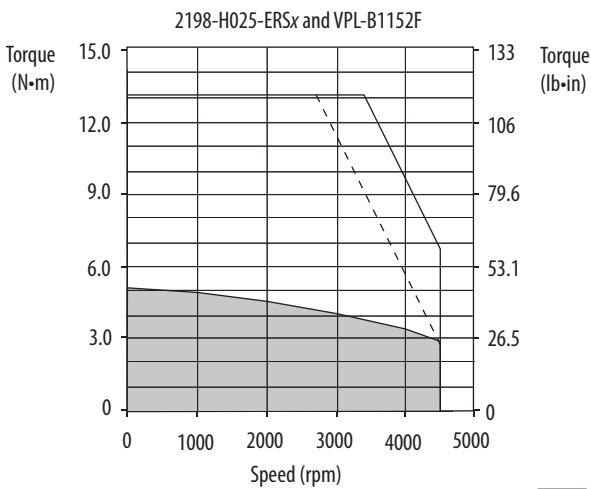
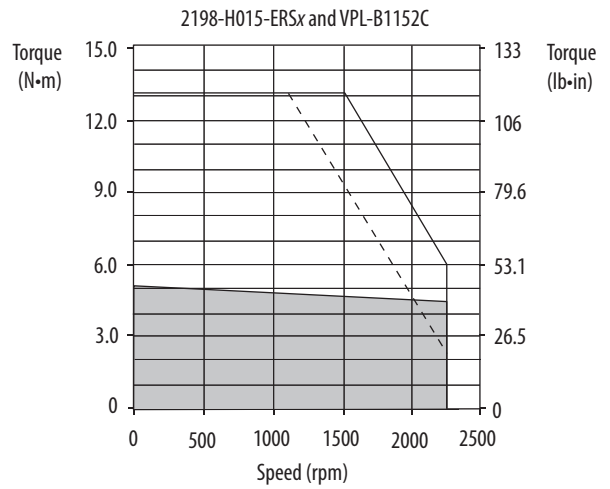
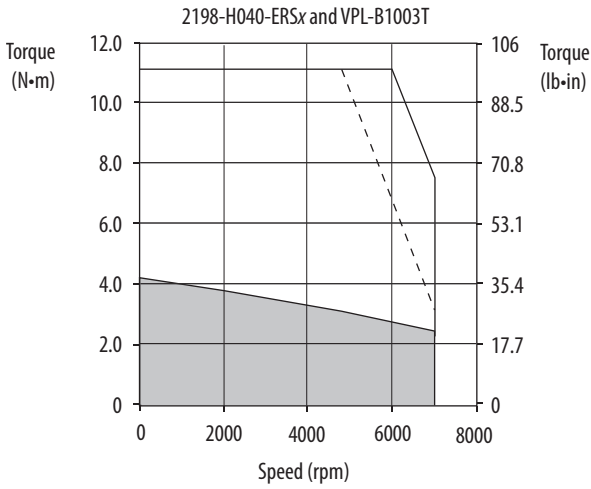
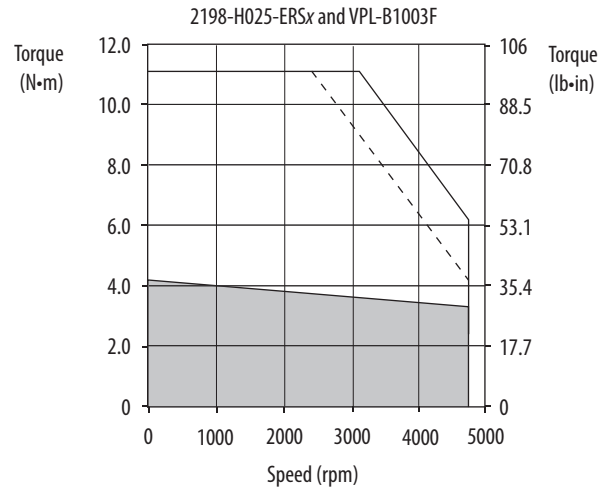
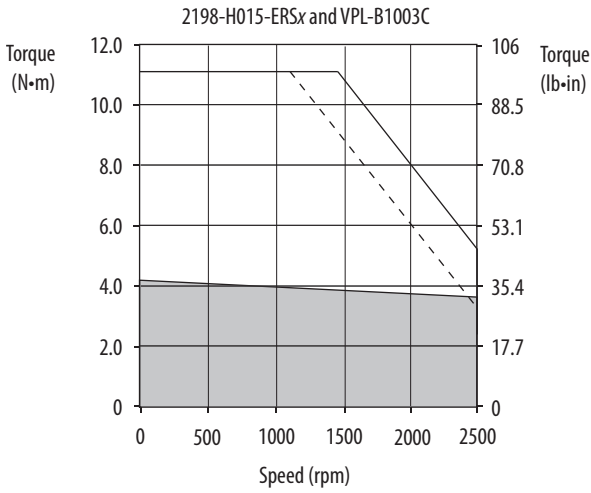

- = Intermittent operating region
- = Continuous operating region
- = Drive operation with 400V AC rms input voltage

Kinetix 5500 (400V-class operation) Drives/Kinetix VP Low Inertia Motor Curves (continued)

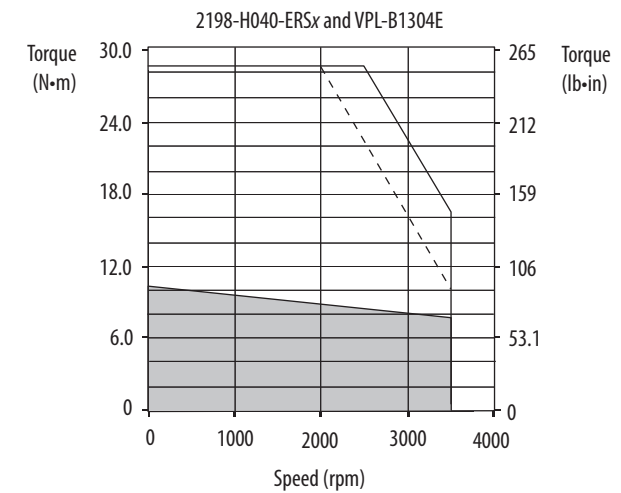
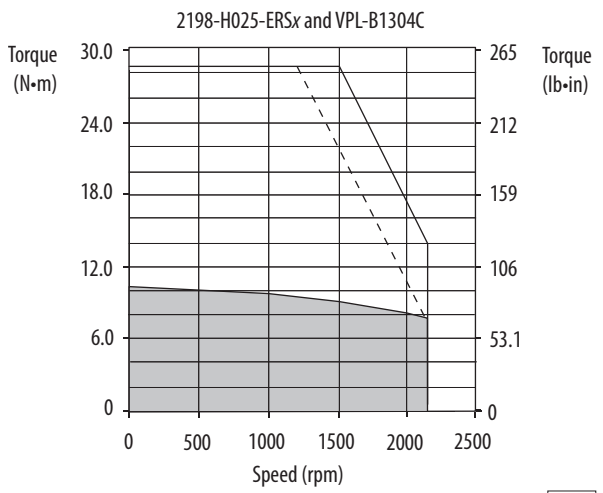
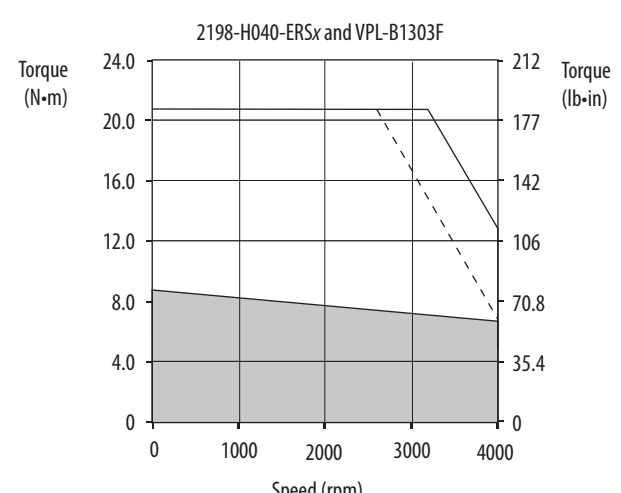
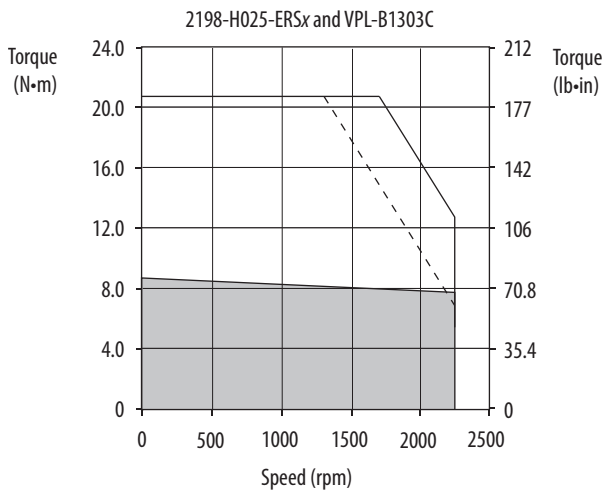
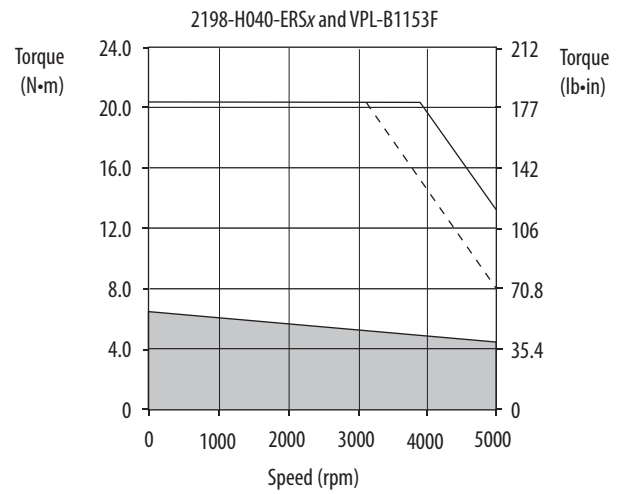
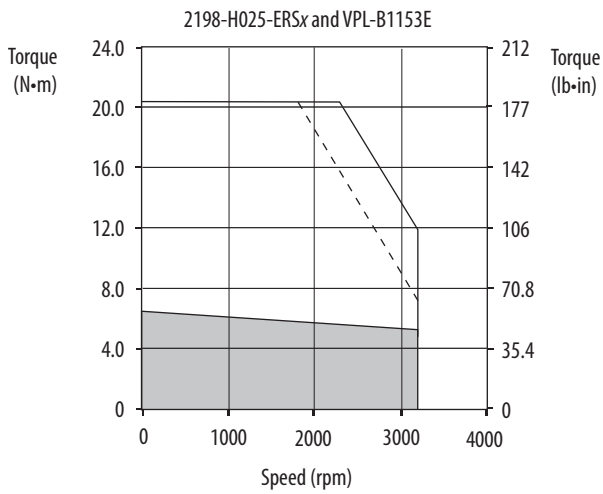

- = Intermittent operating region
- = Continuous operating region
- = Drive operation with 400V AC rms input voltage

Kinetix 5500 (400V-class operation) Drives/Kinetix VP Low Inertia Motor Curves (continued)

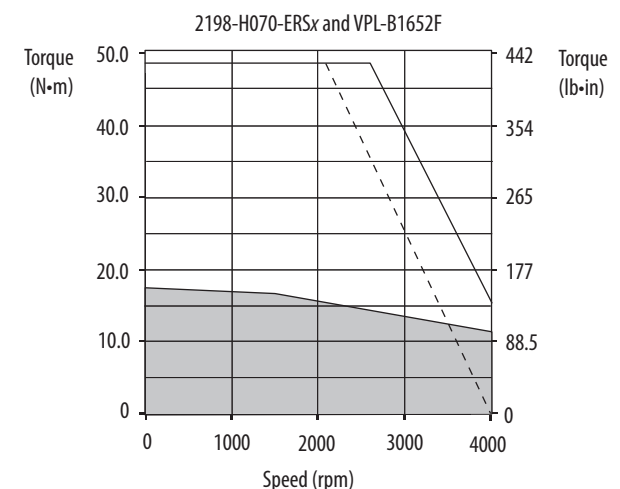
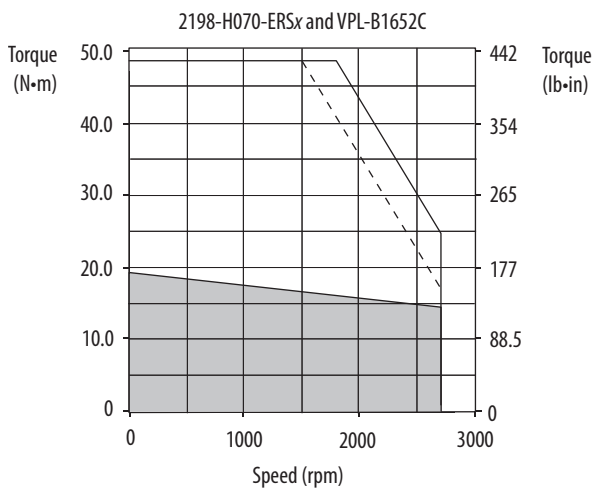
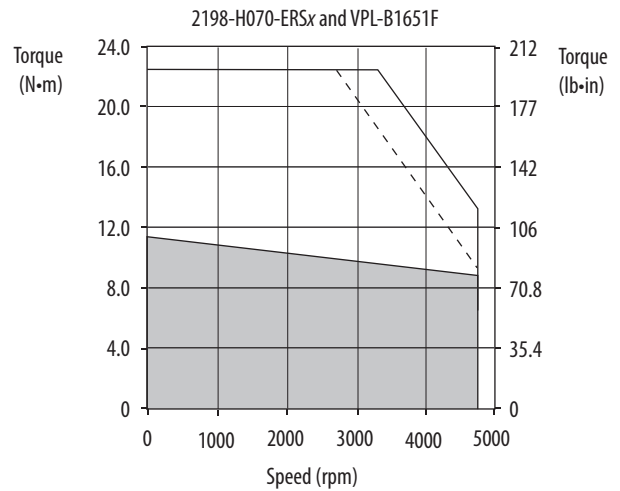
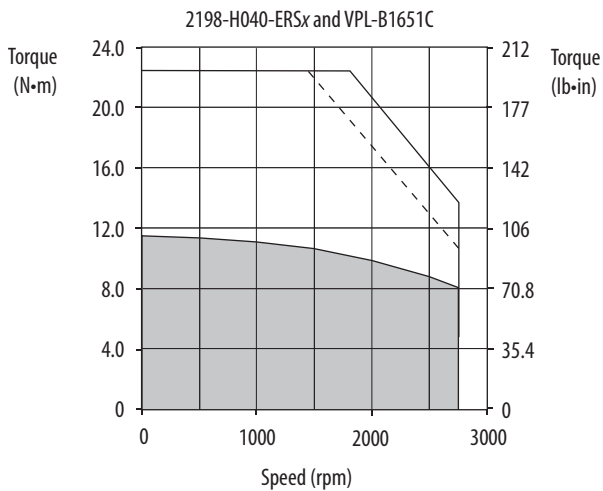
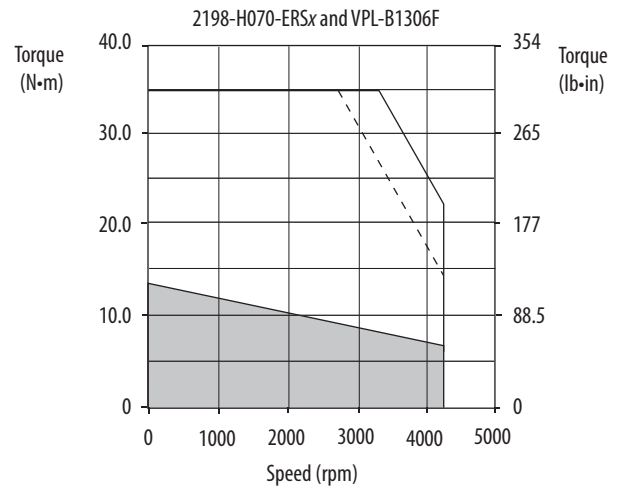
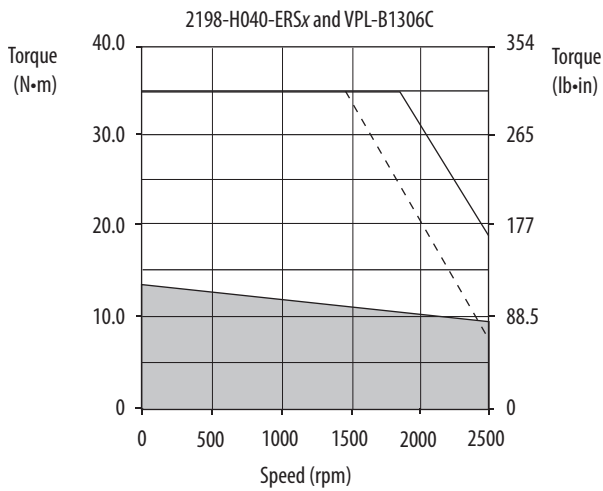

- = Intermittent operating region
- = Continuous operating region
- = Drive operation with 400V AC rms input voltage

Kinetix 5500 (400V-class operation) Drives/Kinetix VP Low Inertia Motor Curves (continued)

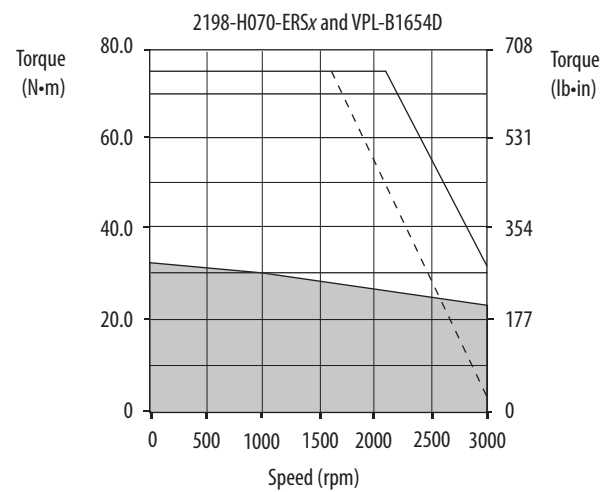
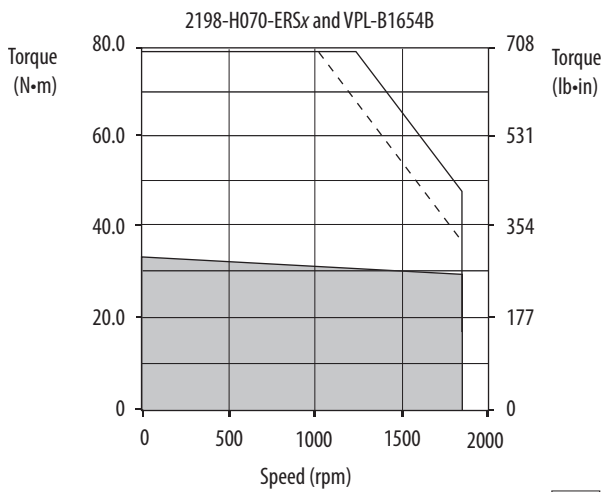
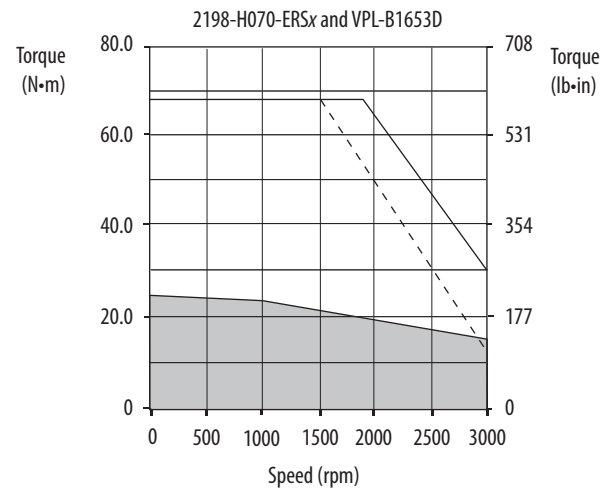
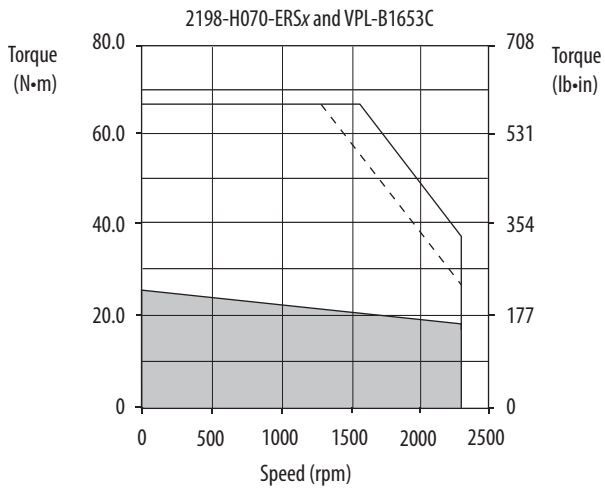

- = Intermittent operating region
- = Continuous operating region
- = Drive operation with 400V AC rms input voltage

Kinetix 5500 (200V-class operation) Drives with Kinetix VP Food Grade Motors

This section provides system combination information for the Kinetix 5500 drives (with 200 and 240V, nominal input) when matched with Kinetix VP (200V-class) food-grade motors. Single cable catalog numbers, system performance specifications, and the optimum torque/speed curves are included.

Kinetix 5500 servo drives are capable of 200V or 400V-class operation. These system performance tables and torque/speed curves reflect single-phase and three-phase drive operation with 200V-class motors; however, only 2198-H003-ERSx, 2198-H008-ERSx, and 2198-H015-ERSx drives are capable of single-phase operation.

Bulletin VPF Motor Cable Combinations

Rotary Motor (200V-class) Cat. No.	Single Cable Cat. No. ⁽¹⁾	Feedback Type
VPF-A0632F, VPF-A0633C, VPF-A0633F	2090-CSBM1Dx-18AAxx or 2090-CSWM1Dx-18AAxx (standard, non-flex) 2090-CSBM1Dx-18AFxx (continuous-flex)	Multi-turn or Single-turn Digital Encoder Feedback
VPF-A0752C, VPF-A0753C		
VPF-A1001C		
VPF-A0752E, VPF-A0753E	2090-CSBM1Dx-14AAxx or 2090-CSWM1Dx-14AAxx (standard, non-flex) 2090-CSBM1Dx-14AFxx (continuous-flex)	
VPF-A1001M, VPF-A1002C, VPF-A1002F		
VPF-A1003C, VPF-A1003E, VPF-A1003F		
VPF-A1153C		
VPF-A1303B, VPF-A1303F		
VPF-A1304A, VPF-A1304D		

(1) Use 2090-CSxM1DF or 2090-CSxM1DG cables. Cable length xx is in meters, 01 (3.3) ... 50 (164) in 1.0 m (3.3 ft) increments. Refer to the Kinetix Motion Accessories Technical Data, publication [KNX-TD004](#), for cable specifications. For cable configuration illustrations and feature descriptions, by catalog number, refer to 2090-Series Single Motor Cable Overview beginning on [page 13](#).

Bulletin VPF Motor Performance Specifications with Kinetix 5500 (200V-class operation) Drives

Rotary Motor Cat. No.	Rated Speed rpm	Speed, max rpm	System Continuous Stall Current A 0-pk	System Continuous Stall Torque N-m (lb-in)	System Peak Stall Current A 0-pk	System Peak Stall Torque N-m (lb-in)	Motor Rated Output kW (Hp)	Kinetix 5500 Drives (240V AC Input)
VPF-A0632F	4800	4800	2.55	0.93 (8.0)	8.75	2.69 (24.0)	0.36 (0.48)	2198-H008-ERSx
VPF-A0633C	3000	3000	2.50	1.27 (11.0)	8.75	4.09 (36.0)	0.37 (0.50)	2198-H008-ERSx
VPF-A0633F	4500	4500	3.52	1.27 (11.0)	8.80	2.87 (25.0)	0.47 (0.63)	2198-H008-ERSx
					12.60	4.09 (36.0)		2198-H015-ERSx
VPF-A0752C	3300	3300	3.80	1.61 (14.0)	13.30	4.39 (39.0)	0.49 (0.66)	2198-H015-ERSx
VPF-A0752E	4800	4800	4.90	1.61 (14.0)	17.70	4.10 (36.0)	0.63 (0.84)	2198-H015-ERSx
					18.90	4.39 (39.0)		2198-H025-ERSx
VPF-A0753C	3300	3300	4.09	2.16 (19.0)	17.70	6.55 (58.0)	0.59 (0.79)	2198-H015-ERSx
					18.90	7.02 (62.0)		2198-H025-ERSx
VPF-A0753E	4600	4600	6.12	2.28 (20.0)	17.70	5.13 (45.0)	0.76 (1.02)	2198-H015-ERSx
					25.34	7.35 (65.0)		2198-H025-ERSx
VPF-A1001C	2800	2800	3.61	1.93 (17.0)	8.80	3.22 (28.0)	0.56 (0.75)	2198-H008-ERSx
					10.38	3.78 (33.0)		2198-H015-ERSx
VPF-A1001M	6500	6500	7.15	1.95 (17.0)	17.70	3.31 (29.0)	1.29 (1.73)	2198-H015-ERSx
					20.20	3.78 (33.0)		2198-H025-ERSx
VPF-A1002C	3000	3000	6.24	3.39 (30.0)	17.70	6.80 (60.0)	1.03 (1.38)	2198-H015-ERSx
					20.33	7.82 (69.0)		2198-H025-ERSx
VPF-A1002F	5000	5000	10.04	3.26 (29.0)	28.30	6.77 (60.0)	1.60 (2.14)	2198-H025-ERSx
					34.30	7.82 (69.0)		2198-H040-ERSx
VPF-A1003C	2250	2250	6.14	4.18 (37.0)	17.70	9.76 (86.0)	0.83 (1.11)	2198-H015-ERSx
					20.20	11.15 (99.0)		2198-H025-ERSx
VPF-A1003E	3750	3750	9.58	4.18 (37.0)	28.30	9.76 (86.0)	1.25 (1.67)	2198-H025-ERSx
					28.80	11.15 (99.0)		2198-H040-ERSx
VPF-A1003F	5500	5500	15.62	4.18 (37.0)	45.90	10.25 (90.0)	1.81 (2.42)	2198-H040-ERSx
					50.0	11.15 (99.0)		2198-H070-ERSx
VPF-A1153C	2300	2300	8.88	6.50 (58.0)	28.30	18.30 (162)	1.16 (1.56)	2198-H025-ERSx
					33.0	20.33 (180)		2198-H040-ERSx
VPF-A1303B	1950	1950	10.34	8.80 (78.0)	28.30	19.85 (175)	1.53 (2.05)	2198-H025-ERSx
					31.0	20.72 (183)		2198-H040-ERSx
VPF-A1303F	4000	4000	18.60	7.75 (69.0)	45.90	15.36 (136)	2.25 (3.02)	2198-H040-ERSx
					62.0	20.72 (183)		2198-H070-ERSx
VPF-A1304A	1600	1600	9.43	10.29 (91.0)	28.30	25.03 (221)	1.47 (1.98)	2198-H025-ERSx
					33.76	28.45 (252)		2198-H040-ERSx
VPF-A1304D	3000	3000	18.40	10.20 (90.0)	45.90	21.48 (190)	1.98 (2.65)	2198-H040-ERSx
					58.0	27.10 (240)		2198-H070-ERSx

Performance specification data and curves reflect nominal system performance of a typical system with the motor at 40 °C (104 °F) and the drive at 50 °C (122 °F) ambient, and rated line voltage. For additional information on ambient and line conditions, refer to Motion Analyzer software.

Kinetix 5500 (200V-class operation) Drives/Kinetix VP Food Grade Motor Curves

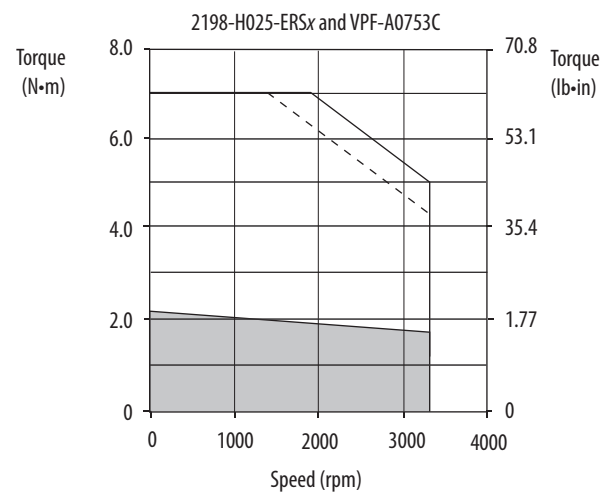
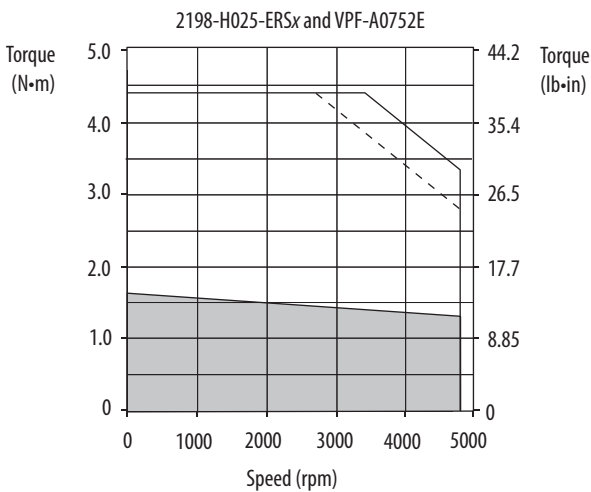
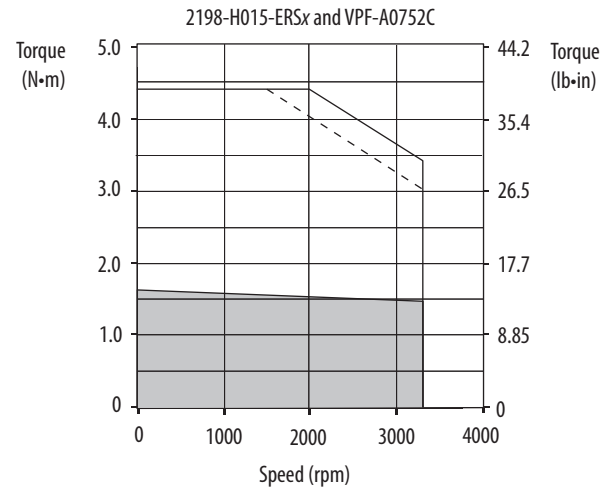
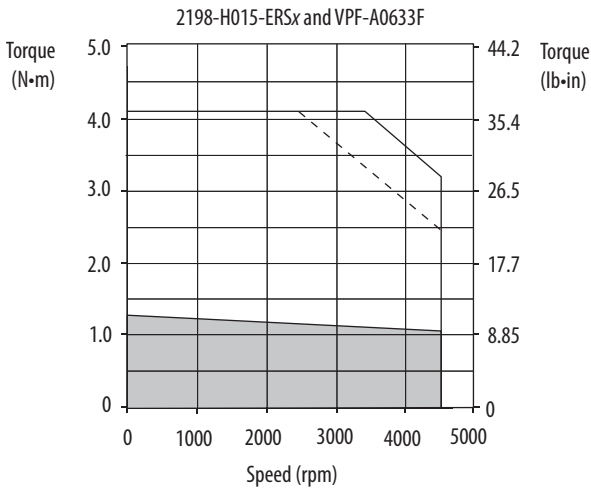
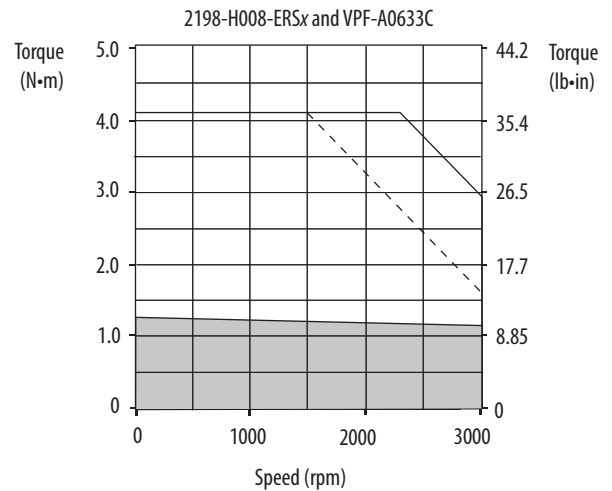
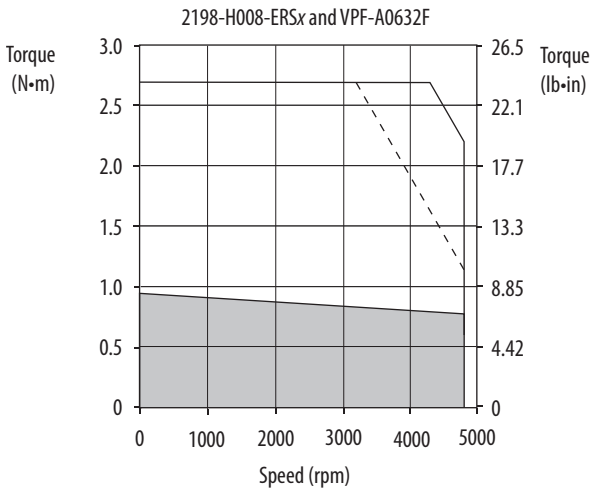

- = Intermittent operating region
- = Continuous operating region
- = Drive operation with 200V AC rms input voltage

Kinetix 5500 (200V-class operation) Drives/Kinetix VP Food Grade Motor Curves (continued)

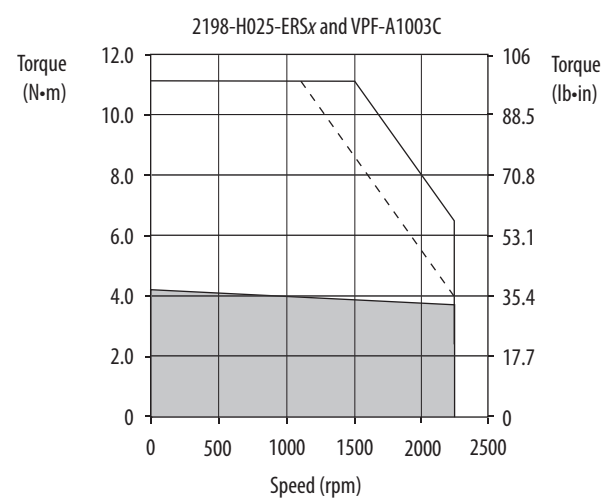
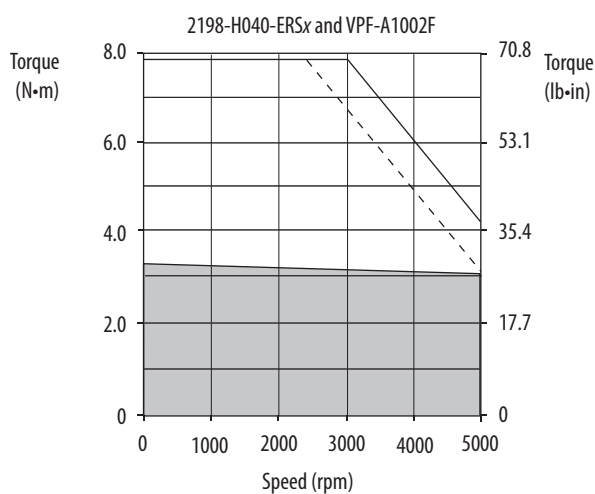
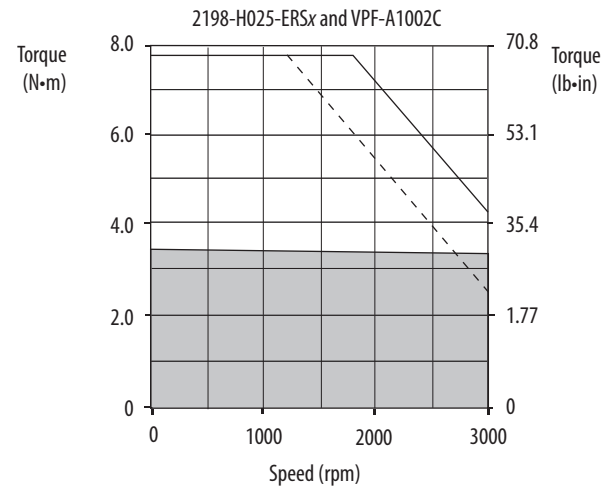
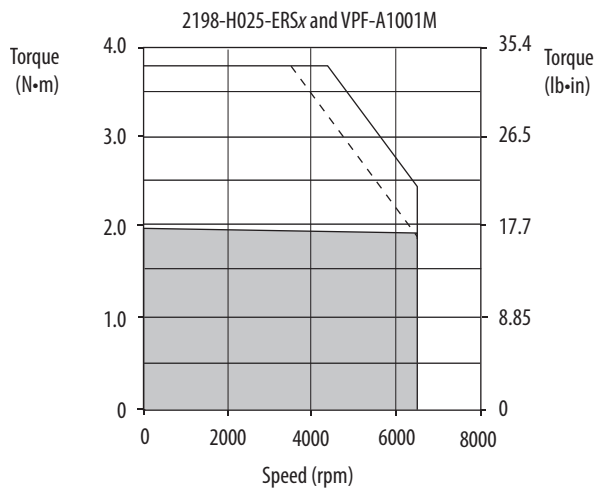
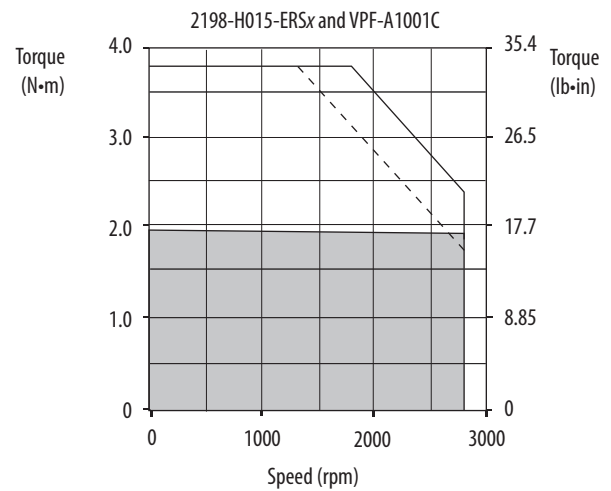
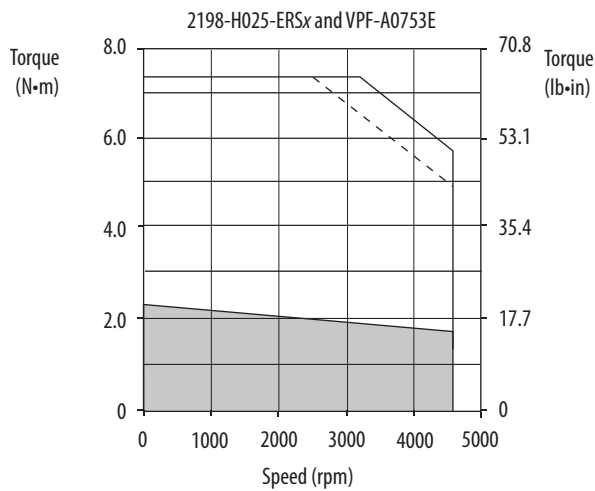

- = Intermittent operating region
- = Continuous operating region
- = Drive operation with 200V AC rms input voltage

Kinetix 5500 (200V-class operation) Drives/Kinetix VP Food Grade Motor Curves (continued)

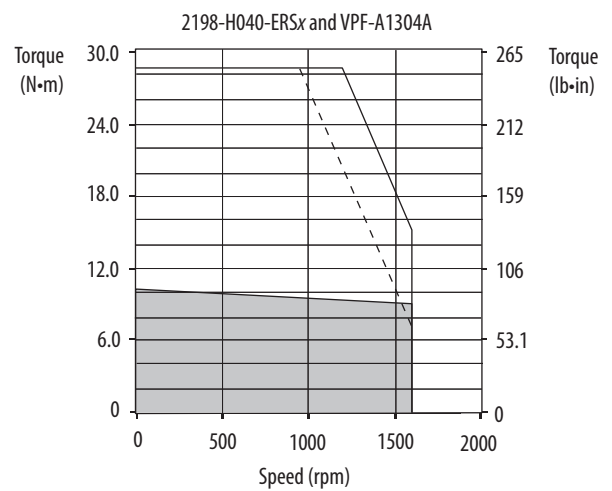
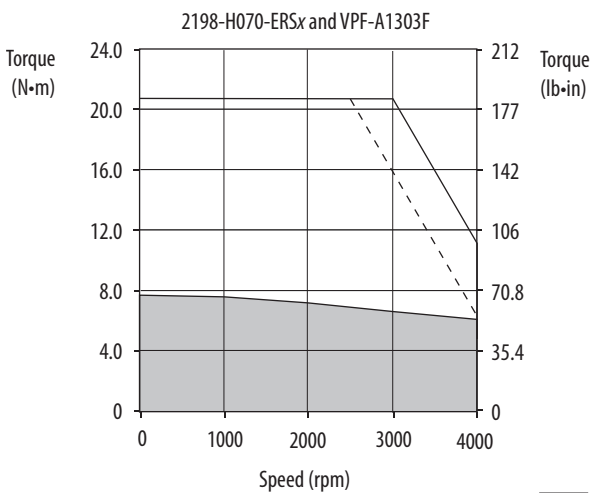
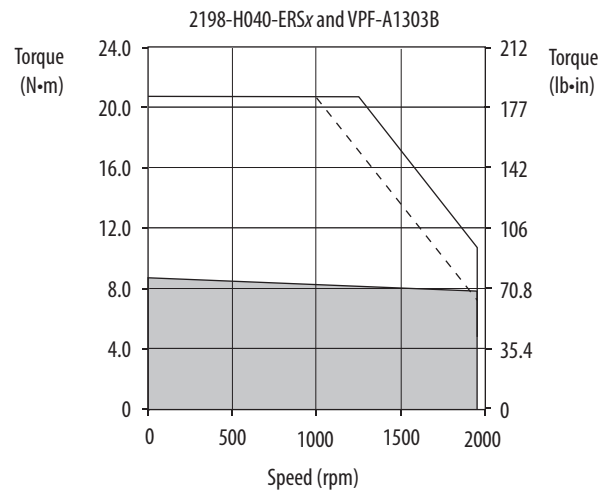
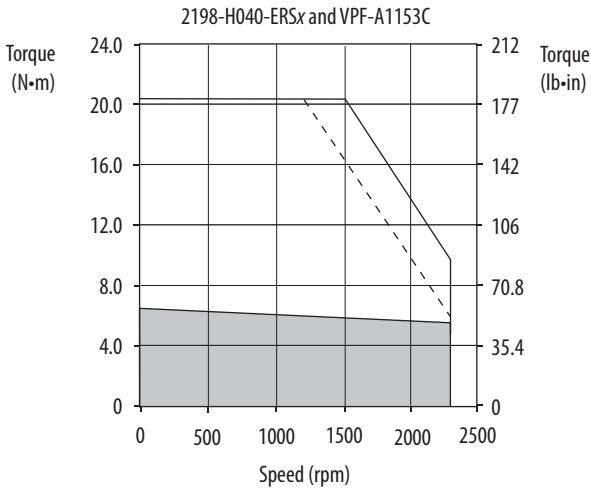
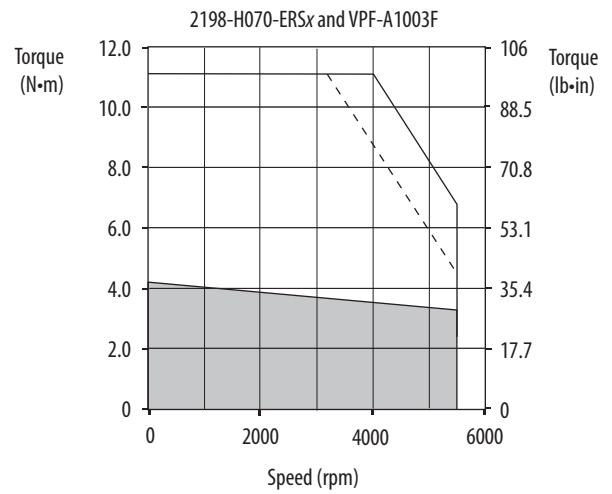
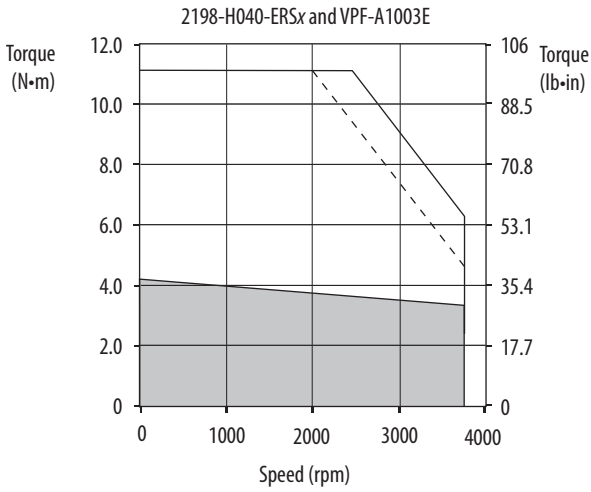

- = Intermittent operating region
- = Continuous operating region
- = Drive operation with 200V AC rms input voltage

Kinetix 5500 (200V-class operation) Drives/Kinetix VP Food Grade Motor Curves (continued)

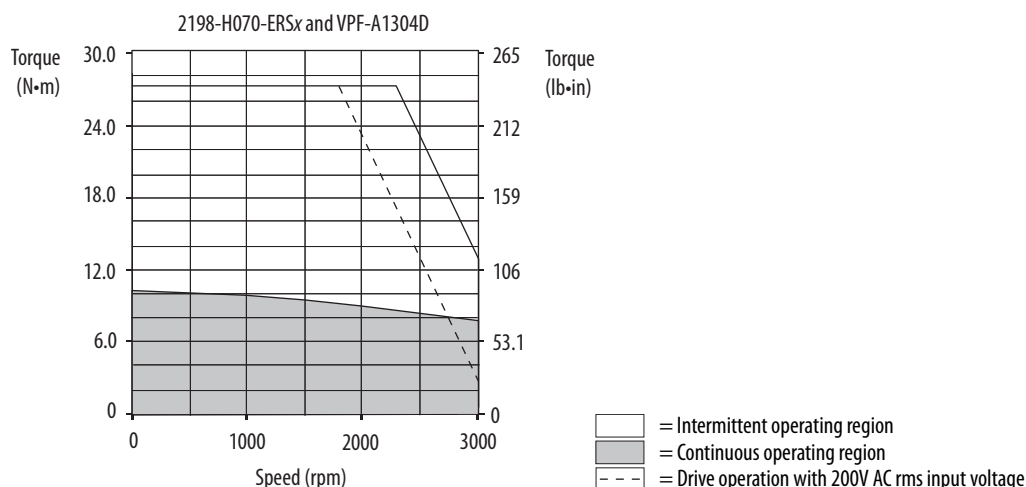

Kinetix 5500 (400V-class operation) Drives with Kinetix VP Food Grade Motors

This section provides system combination information for the Kinetix 5500 drives (with 400 and 480V, nominal input) when matched with Kinetix VP (400V-class) food-grade motors. Single cable catalog numbers, system performance specifications, and the optimum torque/speed curves are included.

Bulletin VPF Motor Cable Combinations

Rotary Motor (400V-class) Cat. No.	Single Cable Cat. No. ⁽¹⁾	Feedback Type
VPF-B0632F, VPF-B0632T, VPF-B0633M, VPF-B0633T	2090-CSBM1Dx-18AAxx or 2090-CSWM1Dx-18AAxx (standard, non-flex) 2090-CSBM1Dx-18AFxx (continuous-flex)	Multi-turn or Single-turn Digital Encoder Feedback
VPF-B0752E, VPF-B0752F, VPF-B0753E, VPF-B0753F		
VPF-B1001M, VPF-B1002E, VPF-B1003C		
VPF-B0752M, VPF-B0753M	2090-CSBM1Dx-14AAxx or 2090-CSWM1Dx-14AAxx (standard, non-flex) 2090-CSBM1Dx-14AFxx (continuous-flex)	
VPF-B1002M, VPF-B1003F, VPF-B1003T		
VPF-B1153E, VPF-B1153F		
VPF-B1303C, VPF-B1303F, VPF-B1304C, VPF-B1304E		
VPF-B1652C		

(1) Use 2090-CSxM1DF or 2090-CSxM1DG cables. Cable length xx is in meters, 01 (3.3) ... 50 (164) in 1.0 m (3.3 ft) increments. Refer to the Kinetix Motion Accessories Technical Data, publication [KNX-TD004](#), for cable specifications. For cable configuration illustrations and feature descriptions, by catalog number, refer to 2090-Series Single Motor Cable Overview beginning on [page 13](#).

Bulletin VPF Motor Performance Specifications with Kinetix 5500 (400V-class operation) Drives

Motor Cat. No.	Rated Speed rpm	Speed, max rpm	System Continuous Stall Current A (0-pk)	System Continuous Stall Torque N·m (lb·in)	System Peak Stall Current A 0-pk	System Peak Stall Torque N·m (lb·in)	Motor Rated Output kW (Hp)	Kinetix 5500 Drives (480V AC input)
VPF-B0632F	4600	4600	1.20	0.93 (8.0)	3.50	2.26 (20.0)	0.34 (0.46)	2198-H003-ERSx
					4.20	2.69 (24.0)		2198-H008-ERSx
VPF-B0632T	8000	8000	2.55	0.93 (8.0)	8.75	2.69 (24.0)	0.41 (0.55)	2198-H008-ERSx
VPF-B0633M	6700	6700	2.50	1.27 (11.0)	8.75	4.09 (36.0)	0.49 (0.66)	2198-H008-ERSx

Bulletin VPF Motor Performance Specifications with Kinetix 5500 (400V-class operation) Drives (cont.)

Motor Cat. No.	Rated Speed rpm	Speed, max rpm	System Continuous Stall Current A (0-pk)	System Continuous Stall Torque N·m (lb·in)	System Peak Stall Current A 0-pk	System Peak Stall Torque N·m (lb·in)	Motor Rated Output kW (Hp)	Kinetix 5500 Drives (480V AC input)
VPF-B0633T	8000	8000	3.52	1.27 (11.0)	8.80	2.87 (25.0)	0.48 (0.64)	2198-H008-ERSx
					12.60	4.09 (36.0)		2198-H015-ERSx
VPF-B0752E	4900	4900	2.70	1.61 (14.0)	8.80	4.10 (36.0)	0.64 (0.86)	2198-H008-ERSx
					9.45	4.39 (39.0)		2198-H015-ERSx
VPF-B0752F	7000	7000	3.80	1.61 (14.0)	13.30	4.39 (39.0)	0.76 (1.02)	2198-H015-ERSx
VPF-B0752M	8000	8000	4.90	1.61 (14.0)	17.70	4.10 (36.0)	0.77 (1.04)	2198-H015-ERSx
					18.90	4.39 (39.0)		2198-H025-ERSx
VPF-B0753E	4500	4500	3.80	2.28 (20.0)	13.30	7.35 (65.0)	0.77 (1.04)	2198-H015-ERSx
VPF-B0753F	6600	6600	4.09	2.16 (19.0)	17.70	6.55 (58.0)	0.61 (0.82)	2198-H015-ERSx
					18.90	7.02 (62.0)		2198-H025-ERSx
VPF-B0753M	8000	8000	6.12	2.28 (20.0)	17.70	5.13 (45.0)	0.78 (1.05)	2198-H015-ERSx
					25.34	7.35 (65.0)		2198-H025-ERSx
VPF-B1001M	6000	6000	3.61	1.93 (17.0)	8.80	3.22 (28.0)	1.14 (1.53)	2198-H008-ERSx
					10.38	3.78 (33.0)		2198-H015-ERSx
VPF-B1002E	3300	3300	3.44	3.39 (30.0)	8.80	6.47 (57.0)	1.12 (1.50)	2198-H008-ERSx
					10.69	7.82 (69.0)		2198-H015-ERSx
VPF-B1002M	6000	6000	6.24	3.39 (30.0)	17.70	6.80 (60.0)	1.86 (2.49)	2198-H015-ERSx
					20.33	7.82 (69.0)		2198-H025-ERSx
VPF-B1003C	2500	2500	3.41	4.18 (37.0)	8.80	9.29 (82.0)	0.91 (1.23)	2198-H008-ERSx
					10.61	11.15 (99.0)		2198-H015-ERSx
VPF-B1003F	4750	4750	6.14	4.18 (37.0)	17.70	9.76 (86.0)	1.57 (2.10)	2198-H015-ERSx
					20.20	11.15 (99.0)		2198-H025-ERSx
VPF-B1003T	7000	7000	9.58	4.18 (37.0)	28.30	9.76 (86.0)	1.68 (2.25)	2198-H025-ERSx
					28.80	11.15 (99.0)		2198-H040-ERSx
VPF-B1153E	3200	3200	6.13	6.50 (58.0)	17.70	16.85 (149)	1.40 (1.88)	2198-H015-ERSx
					21.33	20.33 (180)		2198-H025-ERSx
VPF-B1153F	5000	5000	8.88	6.50 (58.0)	28.30	18.30 (162)	1.49 (2.00)	2198-H025-ERSx
					33.0	20.33 (180)		2198-H040-ERSx
VPF-B1303C	2250	2250	6.30	8.80 (78.0)	17.70	19.83 (175)	1.74 (2.33)	2198-H015-ERSx
					18.47	20.72 (183)		2198-H025-ERSx
VPF-B1303F	4000	4000	10.10	8.80 (78.0)	28.30	19.85 (175)	2.54 (3.40)	2198-H025-ERSx
					31.0	20.72 (183)		2198-H040-ERSx
VPF-B1304C	2150	2150	7.0	10.29 (91.0)	17.70	22.55 (199)	1.49 (2.00)	2198-H015-ERSx
					22.3	28.45 (252)		2198-H025-ERSx
VPF-B1304E	3500	3500	9.44	10.29 (91.0)	28.30	25.03 (221)	2.40 (3.21)	2198-H025-ERSx
					33.76	28.45 (252)		2198-H040-ERSx
VPF-B1652C	2700	2700	16.0	19.40 (172)	45.90	44.78 (396)	4.18 (5.60)	2198-H040-ERSx
					49.88	48.60 (430)		2198-H070-ERSx

Performance specification data and curves reflect nominal system performance of a typical system with the motor at 40 °C (104 °F) and the drive at 50 °C (122 °F) ambient, and rated line voltage. For additional information on ambient and line conditions, refer to Motion Analyzer software.

Kinetix 5500 (400V-class operation) Drives/Kinetix VP Food Grade Motor Curves

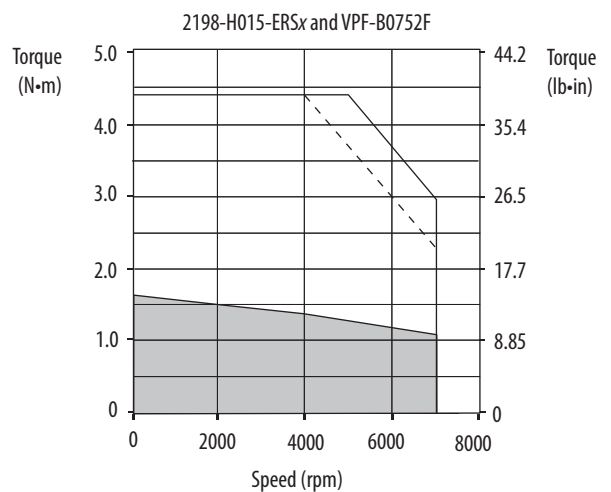
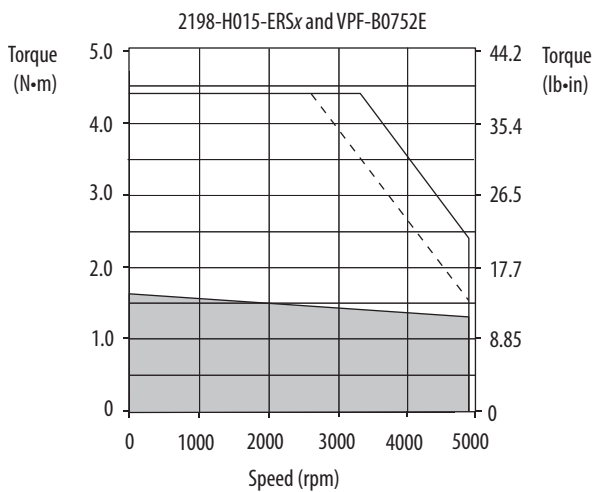
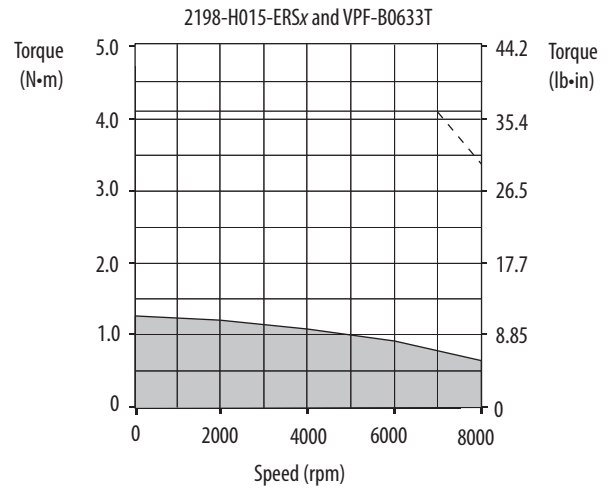
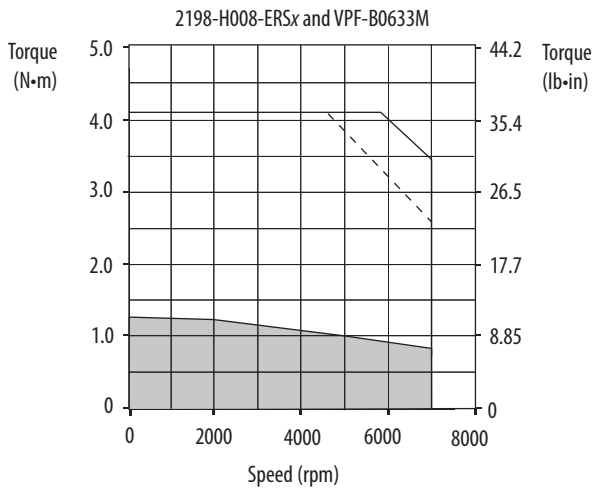
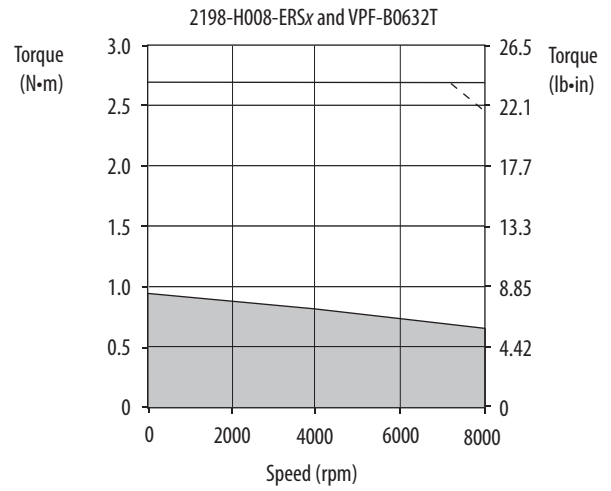
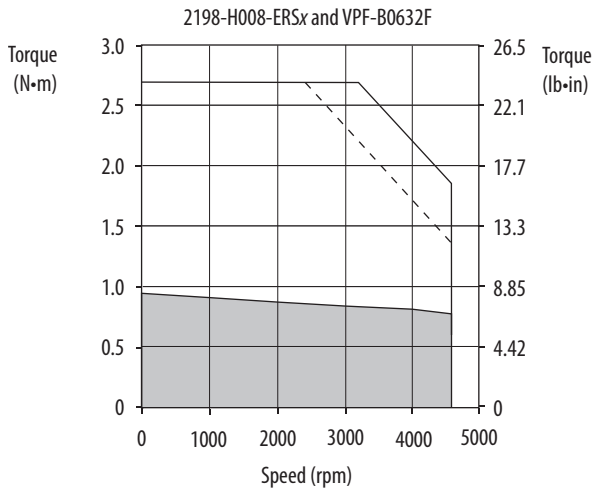

- = Intermittent operating region
- = Continuous operating region
- = Drive operation with 400V AC rms input voltage

Kinetix 5500 (400V-class operation) Drives/Kinetix VP Food Grade Motor Curves (continued)

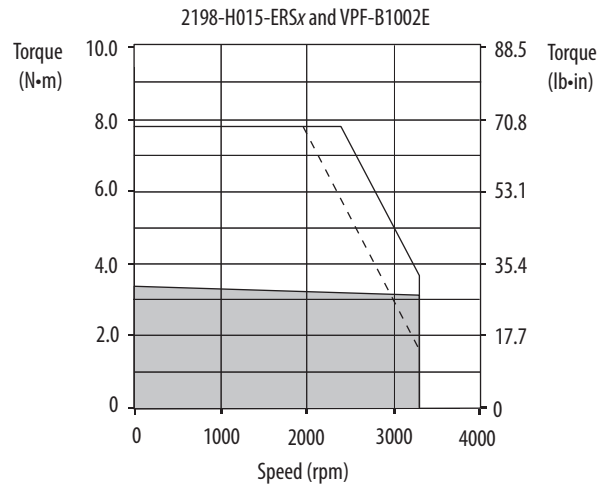
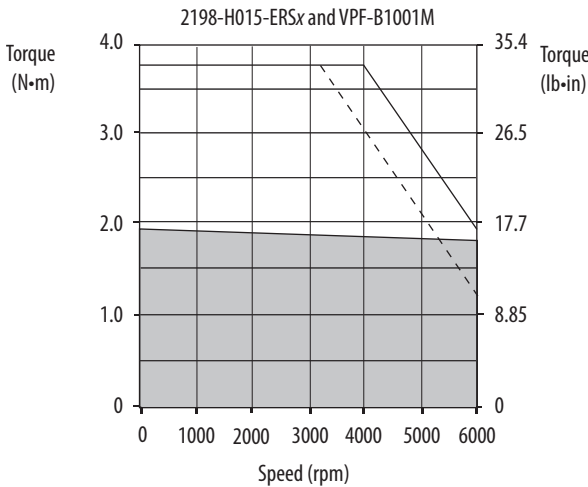
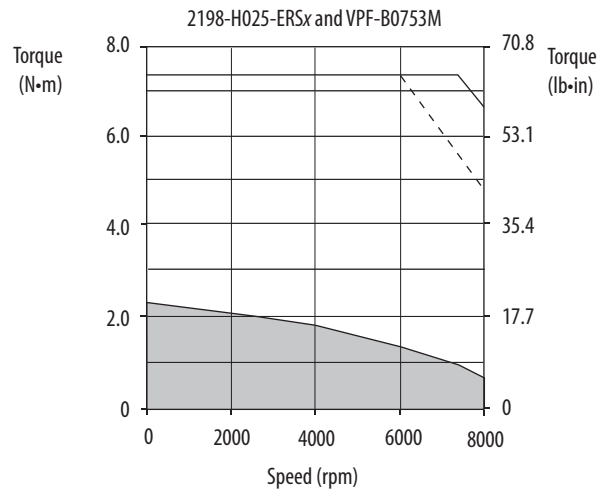
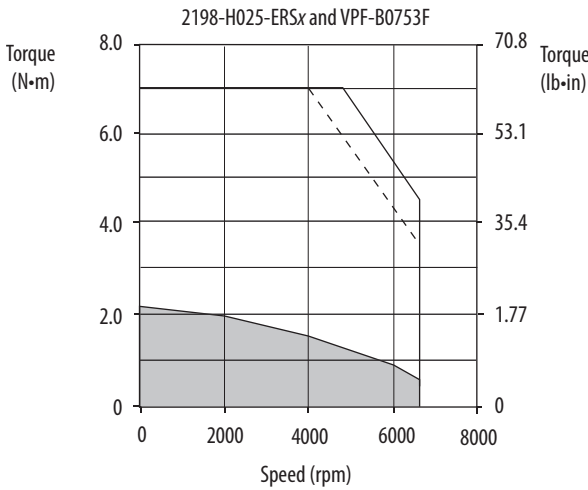
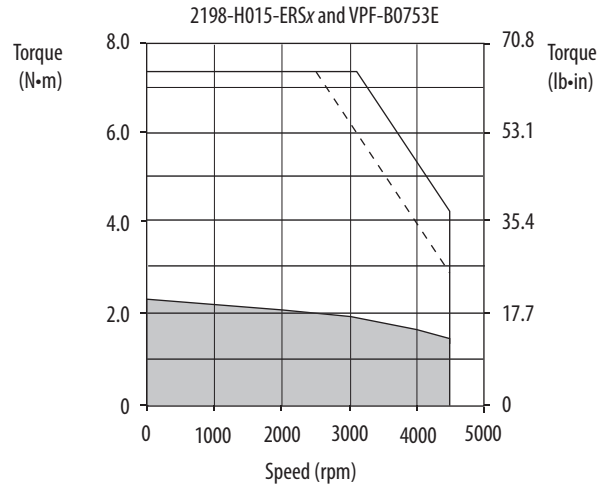
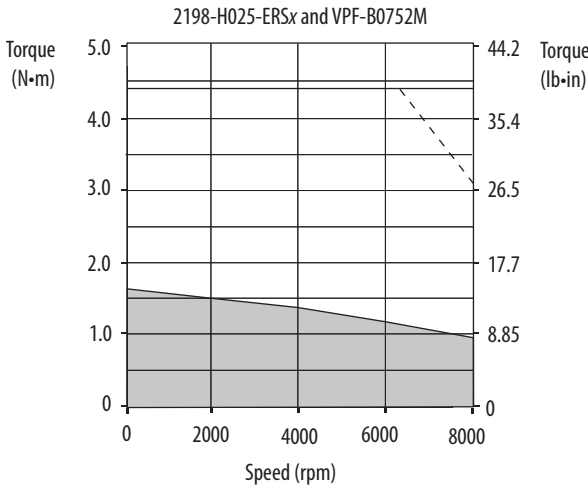

= Intermittent operating region
 = Continuous operating region
 = Drive operation with 400V AC rms input voltage

Kinetix 5500 (400V-class operation) Drives/Kinetix VP Food Grade Motor Curves (continued)

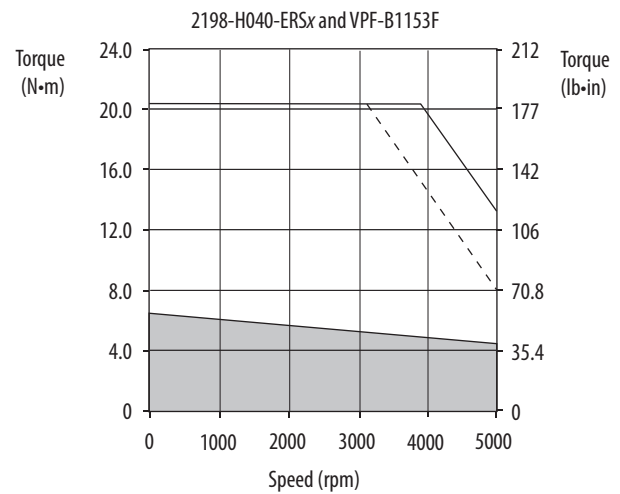
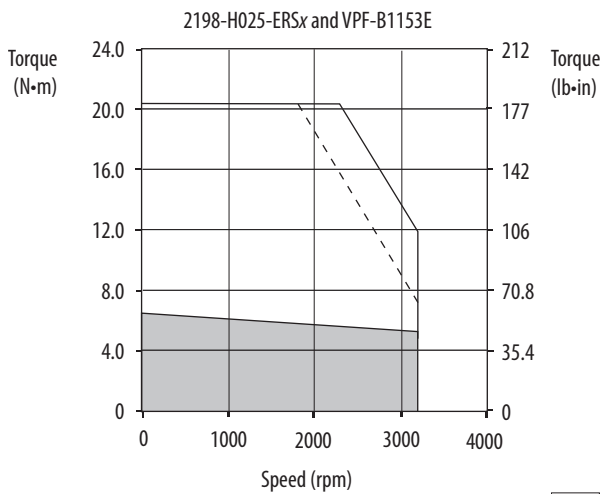
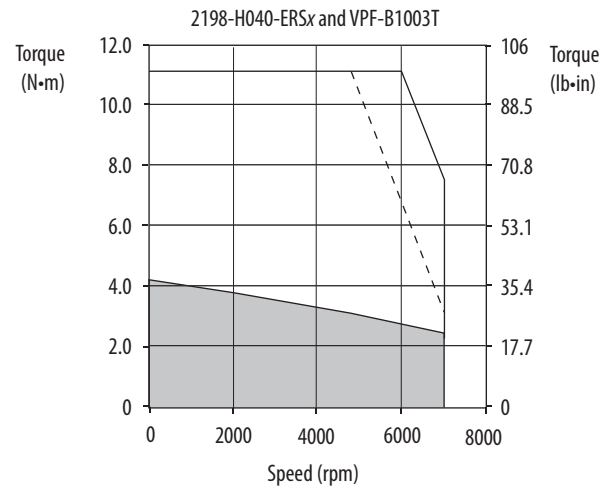
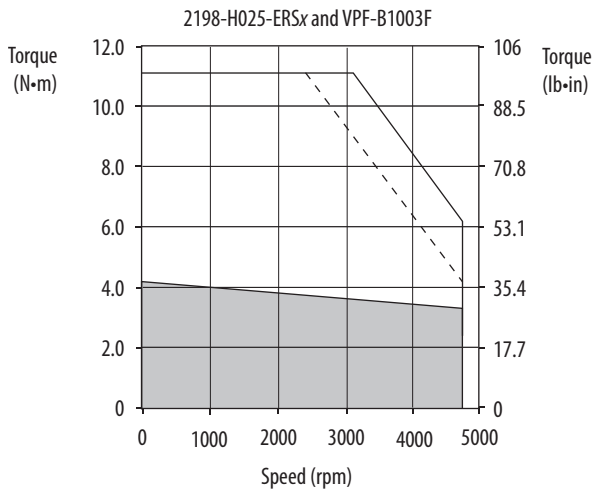
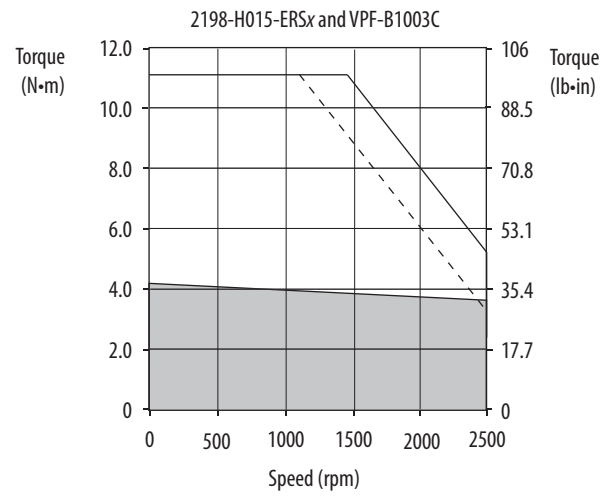
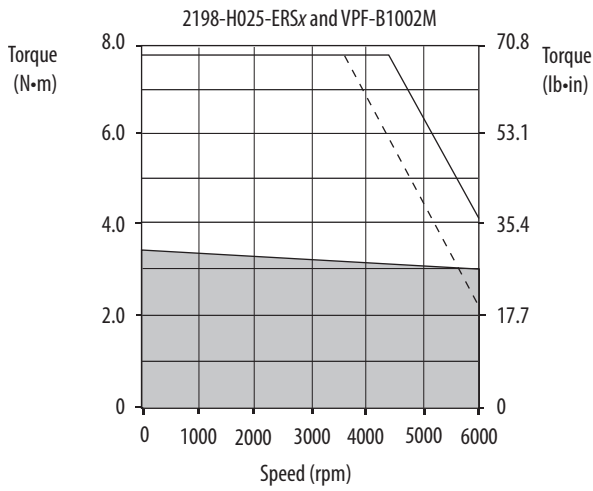

= Intermittent operating region
 = Continuous operating region
 = Drive operation with 400V AC rms input voltage

Kinetix 5500 (400V-class operation) Drives/Kinetix VP Food Grade Motor Curves (continued)

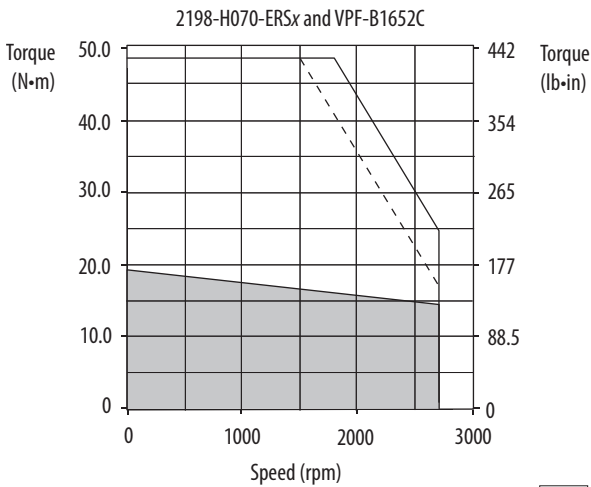
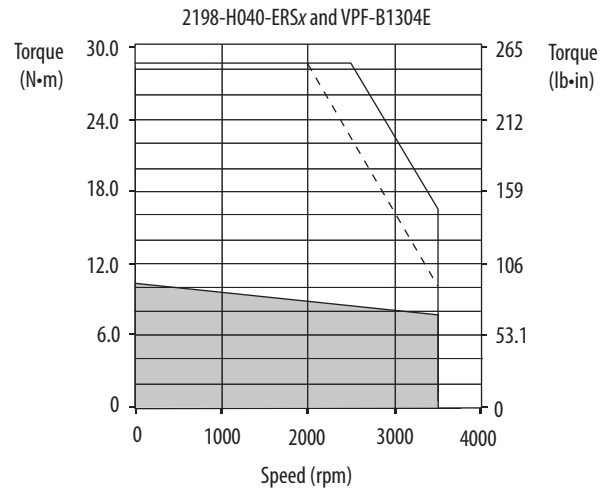
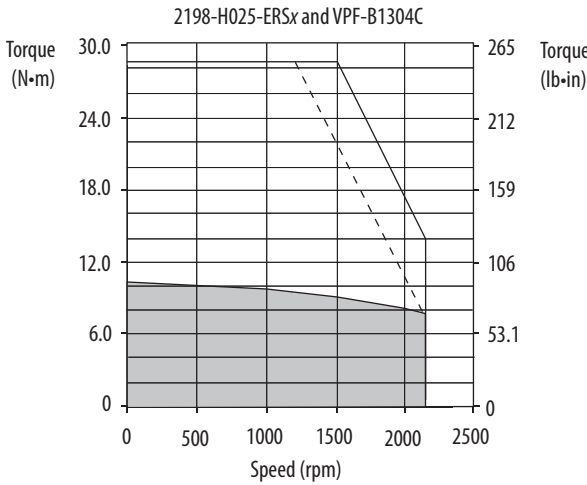
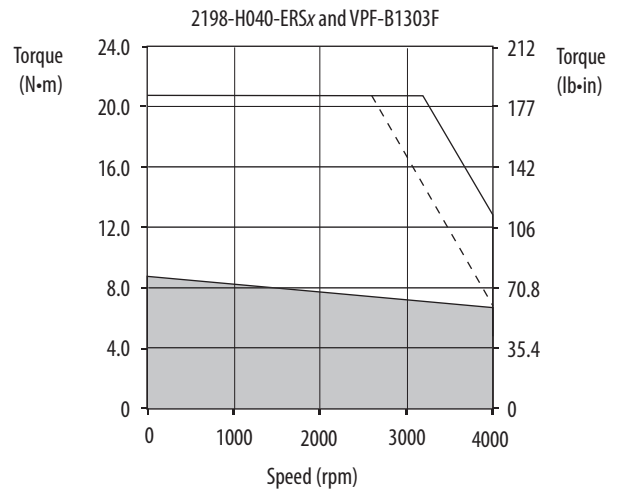
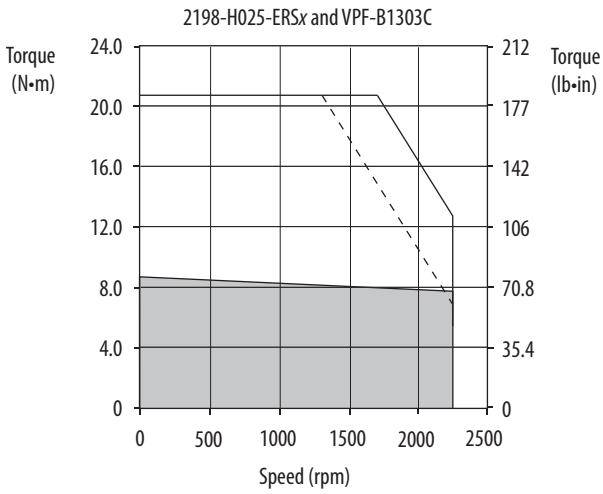

- = Intermittent operating region
- = Continuous operating region
- = Drive operation with 400V AC rms input voltage

Kinetix 5500 (200V-class) Drives with Kinetix VP Hygienic Stainless Steel Motors

This section provides system combination information for the Kinetix 5500 drives (with 240V, nominal input) when matched with Kinetix VP (200V-class) hygienic stainless-steel motors. Single-cable catalog numbers, system performance specifications, and optimum torque/speed curves are included.

Kinetix 5500 servo drives are capable of 200V or 400V-class operation. These system performance tables and torque/speed curves reflect single-phase and three-phase drive operation with 200V-class motors; however, only 2198-H003-ERSx, 2198-H008-ERSx, and 2198-H015-ERSx drives are capable of single-phase operation.

Bulletin VPH Motor Cable Combinations

Rotary Motor (200V-class) ⁽¹⁾ Cat. No.	Single Cable Cat. No. ⁽²⁾	Feedback Type
VPH-A0633F VPH-A0753F	2090-CSBM1Dx-18AAxx or 2090-CSWM1Dx-18AAxx (standard, non-flex) 2090-CSBM1Dx-18AFxx (continuous-flex)	Multi-turn or Single-turn Digital Encoder Feedback
VPH-A1003F	2090-CSBM1Dx-14AAxx or 2090-CSWM1Dx-14AAxx (standard, non-flex) 2090-CSBM1Dx-14AFxx (continuous-flex)	
VPH-A1152E VPH-A1153C	2090-CSBM1Dx-18AAxx or 2090-CSWM1Dx-18AAxx (standard, non-flex) 2090-CSBM1Dx-18AFxx (continuous-flex)	
VPH-A1304D	2090-CSBM1Dx-14AAxx or 2090-CSWM1Dx-14AAxx (standard, non-flex) 2090-CSBM1Dx-14AFxx (continuous-flex)	

(1) The VPH-A115xx frame on-motor cables include 14 AWG conductors and are also compatible with 2090-CSxM1Dx-14Axxx cable.

(2) Use 2090-CSxM1DF or 2090-CSxM1DG cables. Cable length xx is in meters, 01 (3.3) . . . 50 (164) in 1.0 m (3.3 ft) increments. Refer to the Kinetix Motion Accessories Technical Data, publication [KNX-TD004](#), for cable specifications. For cable configuration illustrations and feature descriptions, by catalog number, refer to 2090-Series Single Motor Cable Overview beginning on [page 13](#).

Bulletin VPH (non-brake) Motor Performance Specifications with Kinetix 5500 (200V-class operation) Drives

Rotary Motor Cat. No.	Rated Speed rpm	Speed, max rpm	System Continuous Stall Current A 0-pk	System Continuous Stall Torque N·m (lb·in)	System Peak Stall Current A 0-pk	System Peak Stall Torque N·m (lb·in)	Motor Rated Output kW (Hp)	Kinetix 5500 Drives (240V AC operation)
VPH-A0633F-xxx2	4500	4500	2.06	1.09 (9.7)	8.80	2.79 (24.7)	0.45 (0.61)	2198-H008-ERSx
					13.60	4.30 (38.1)		2198-H015-ERSx
VPH-A0753F-xxx2	4600	4600	3.73	1.90 (16.8)	17.70	4.88 (43.2)	0.68 (0.92)	2198-H015-ERSx
					25.34	7.00 (62.0)		2198-H025-ERSx
VPH-A1003F-xxx2	5500	5500	8.45	3.41 (30.1)	28.3	4.97 (44.0)	1.32 (1.77)	2198-H025-ERSx
					71.10	12.50 (111)		2198-H070-ERSx
VPH-A1152E-xxx2	3300	3300	5.66	4.04 (35.8)	17.70	7.94 (70.3)	1.07 (1.43)	2198-H015-ERSx
					33.20	14.91 (132)		2198-H040-ERSx
VPH-A1153C-xxx2	2300	2300	4.99	5.17 (45.8)	17.70	11.72 (104)	1.11 (1.49)	2198-H015-ERSx
					33.00	21.88 (194)		2198-H040-ERSx
VPH-A1304D-xxx2	3000	3000	10.03	8.44 (74.7)	28.30	14.00 (124)	1.79 (2.40)	2198-H025-ERSx
					61.20	30.30 (268)		2198-H070-ERSx

Performance specification data and curves reflect nominal system performance of a typical system with motor at 40 °C (104 °F) and drive at 40 °C (104 °F) ambient and rated line voltage. For additional information on ambient and line conditions, refer to Motion Analyzer software.

Bulletin VPH (brake) Motor Performance Specifications with Kinetix 5500 (200V-class operation) Drives

Rotary Motor Cat. No.	Rated Speed rpm	Speed, max rpm	System Continuous Stall Current A 0-pk	System Continuous Stall Torque N·m (lb·in)	System Peak Stall Current A 0-pk	System Peak Stall Torque N·m (lb·in)	Motor Rated Output kW (Hp)	Kinetix 5500 Drives (240V AC operation)
VPH-A0633F-xxx4	4500	4500	2.06	1.07 (9.5)	8.80	2.79 (24.7)	0.43 (0.57)	2198-H008-ERSx
					13.60	4.30 (38.1)		2198-H015-ERSx
VPH-A0753F-xxx4	4600	4600	3.53	1.73 (15.3)	17.70	4.88 (43.2)	0.60 (0.80)	2198-H015-ERSx
					25.34	7.00 (62.0)		2198-H025-ERSx
VPH-A1003F-xxx4	5500	5500	8.27	3.18 (28.2)	28.30	4.97 (44.0)	1.06 (1.42)	2198-H025-ERSx
					71.10	12.50 (111)		2198-H070-ERSx
VPH-A1152E-xxx4	3300	3300	5.54	4.00 (35.4)	17.70	7.94 (70.3)	1.07 (1.43)	2198-H015-ERSx
					33.20	14.91 (132)		2198-H040-ERSx
VPH-A1153C-xxx4	2300	2300	4.90	5.03 (44.5)	17.70	11.72 (104)	1.11 (1.49)	2198-H015-ERSx
					33.00	21.88 (194)		2198-H040-ERSx
VPH-A1304D-xxx4	3000	3000	9.70	8.27 (73.2)	28.30	14.00 (124)	1.79 (2.40)	2198-H025-ERSx
					61.20	30.30 (268)		2198-H070-ERSx

Performance specification data and curves reflect nominal system performance of a typical system with motor at 40 °C (104 °F) and drive at 40 °C (104 °F) ambient and rated line voltage. For additional information on ambient and line conditions, refer to Motion Analyzer software.

Kinetix 5500 (200V-class operation) Drives/Kinetix VP Hygienic Stainless Steel Motor Curves

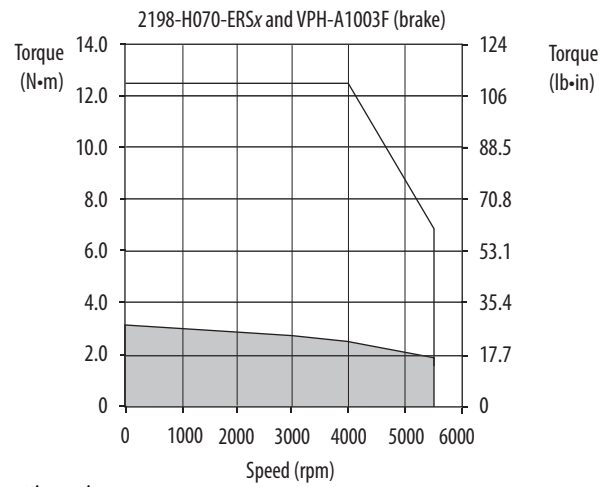
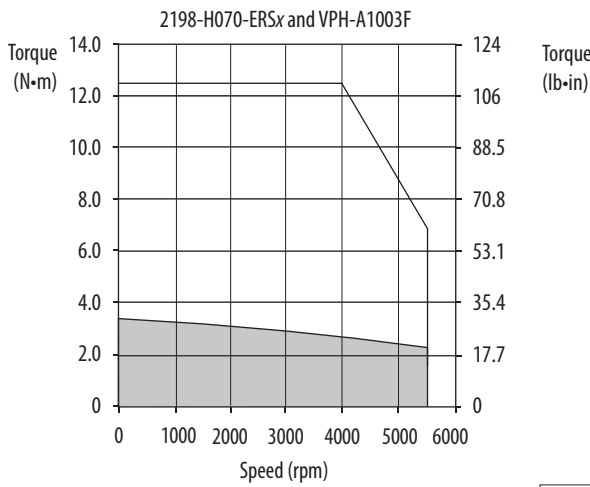
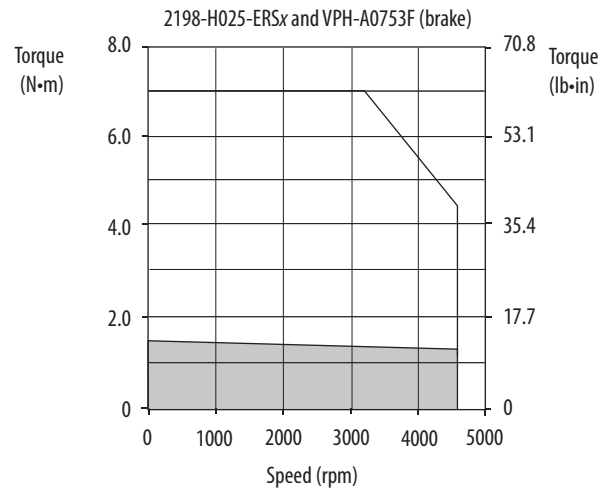
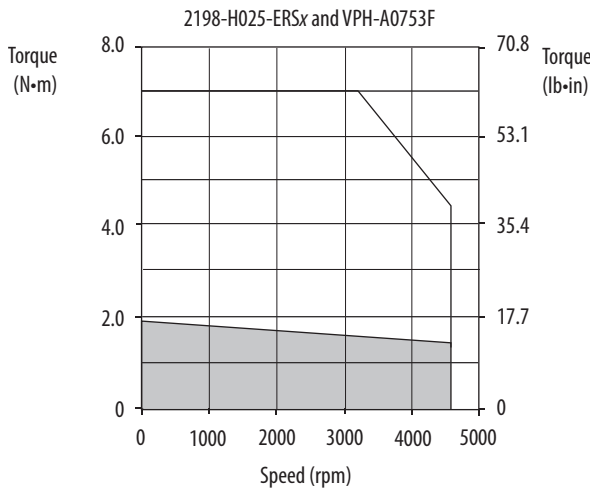
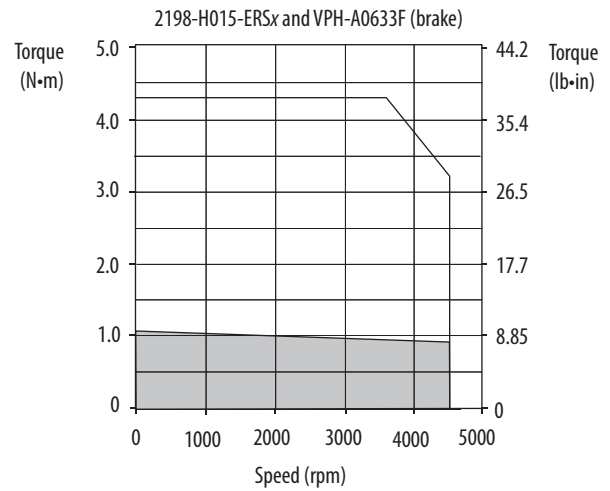
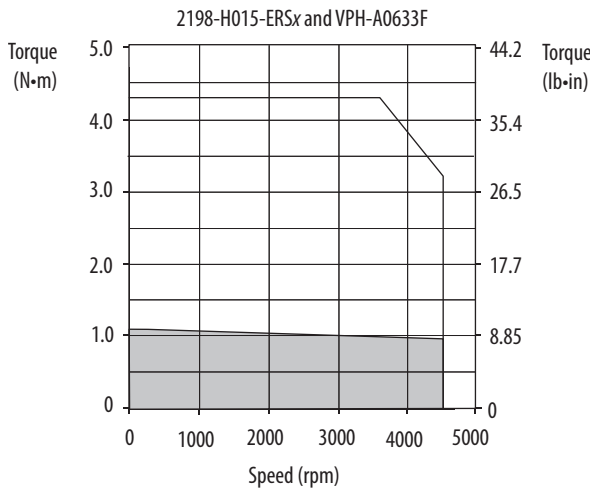

= Intermittent operating region
 = Continuous operating region

Kinetix 5500 (200V-class operation) Drives/Kinetix VP Hygienic Stainless Steel Motor Curves (continued)

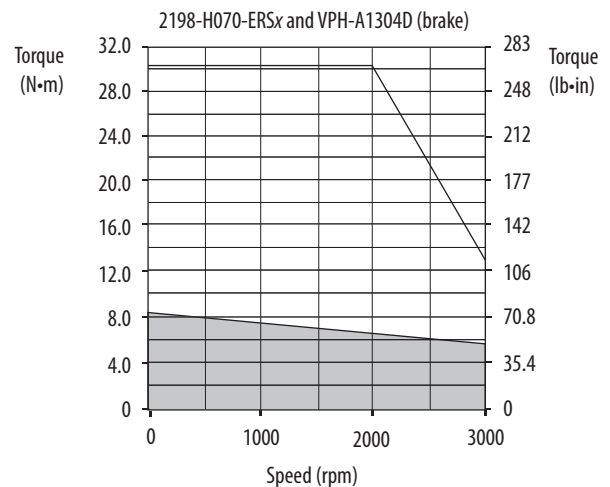
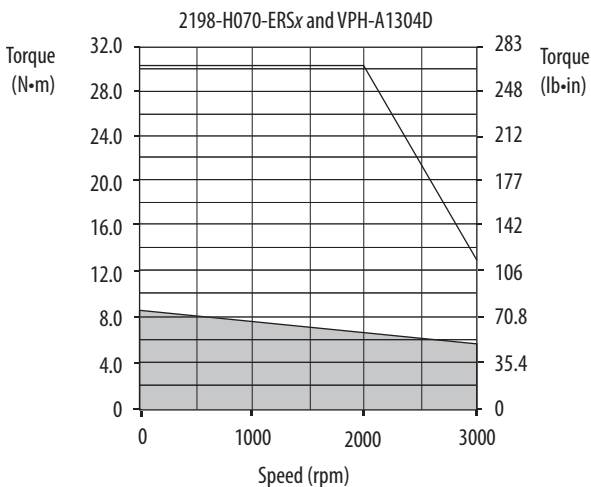
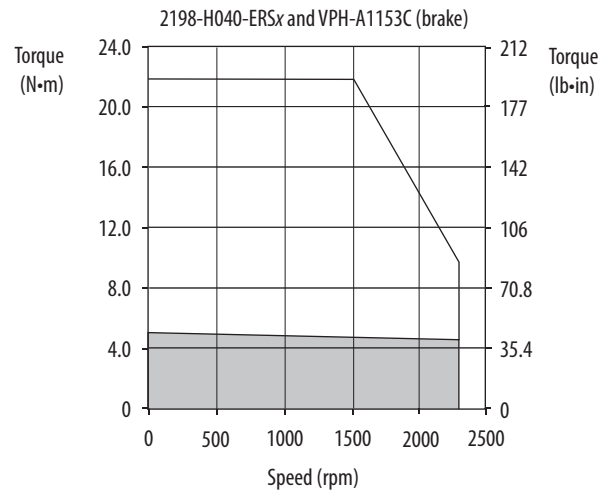
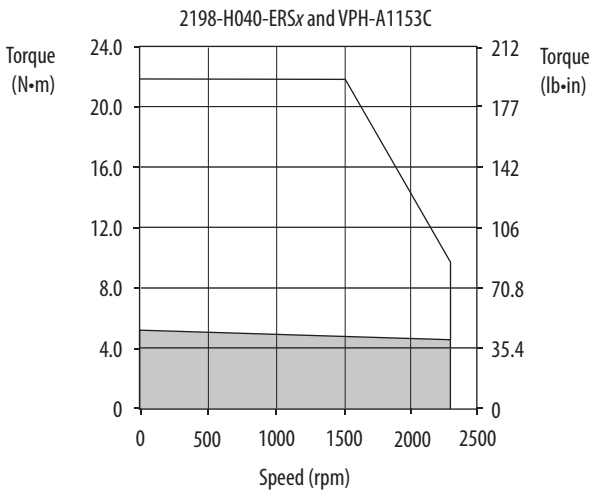
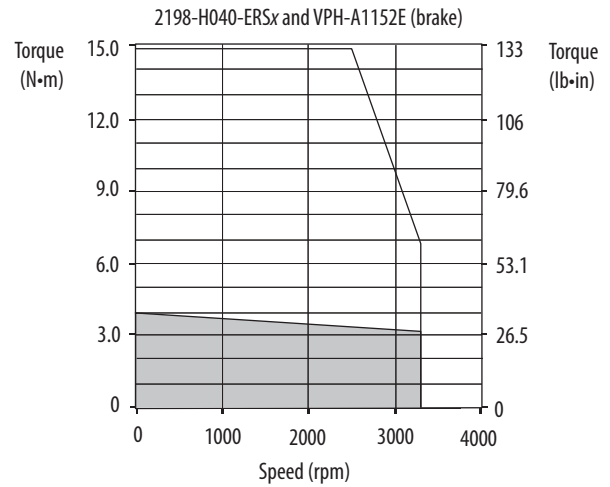
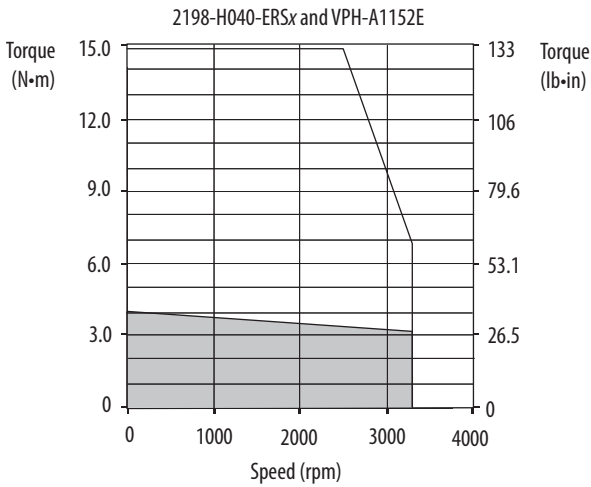

= Intermittent operating region
 = Continuous operating region

Kinetix 5500 (400V-class) Drives with Kinetix VP Hygienic Stainless Steel Motors

This section provides system combination information for the Kinetix 5500 drives (with 480V, nominal input) when matched with Kinetix VP (400V-class) hygienic stainless-steel motors. Single cable catalog numbers, system performance specifications, and optimum torque/speed curves are included.

Bulletin VPH Motor Cable Combinations

Rotary Motor (400V-class) ⁽¹⁾ Cat. No.	Single Cable Cat. No. ⁽²⁾	Feedback Type
VPH-B0632T, VPH-B0633M	2090-CSBM1Dx-18AAxx or 2090-CSWM1Dx-18AAxx (standard, non-flex) 2090-CSBM1Dx-18AFxx (continuous-flex)	Multi-turn or Single-turn Digital Encoder Feedback
VPH-B0753F		
VPH-B1001F, VPH-B1003F		
VPH-B1152F, VPH-B1153E		
VPH-B1304E		
VPH-B1653D	2090-CSBM1Dx-14AAxx or 2090-CSWM1Dx-14AAxx (standard, non-flex) 2090-CSBM1Dx-14AFxx (continuous-flex)	

(1) The VPH-B100xx, VPH-B115xx, and VPH-B130xx frame on-motor cables include 14 AWG conductors and are also compatible with 2090-CSxM1Dx-14Axxx cable.

(2) Use 2090-CSxM1DF or 2090-CSxM1DG cables. Cable length xx is in meters, 01 (3.3) ... 50 (164) in 1.0 m (3.3 ft) increments. Refer to the Kinetix Motion Accessories Technical Data, publication [KNX-TD004](#), for cable specifications. For cable configuration illustrations and feature descriptions, by catalog number, refer to 2090-Series Single Motor Cable Overview beginning on [page 13](#).

Bulletin VPH (non-brake) Motor Performance Specifications with Kinetix 5500 (400V-class operation) Drives

Rotary Motor Cat. No.	Rated Speed rpm	Speed, max rpm	System Continuous Stall Current A 0-pk	System Continuous Stall Torque N·m (lb·in)	System Peak Stall Current A 0-pk	System Peak Stall Torque N·m (lb·in)	Motor Rated Output kW (Hp)	Kinetix 5500 Drives (480V AC operation)
VPH-B0632T-xxx2	8000	8000	1.73	0.84 (7.5)	8.80	2.37 (21.0)	0.52 (0.69)	2198-H008-ERSx
					10.30	2.76 (24.4)		2198-H015-ERSx
VPH-B0633M-xxx2	6700	6700	1.45	1.03 (9.2)	8.75	4.16 (36.8)	0.50 (0.67)	2198-H008-ERSx
VPH-B0753F-xxx2	6600	6600	2.60	1.87 (16.6)	8.80	3.41 (30.2)	0.74 (0.99)	2198-H008-ERSx
					18.90	7.30 (64.6)		2198-H025-ERSx
VPH-B1001F-xxx2	5000	5000	1.55	1.44 (12.8)	7.80	3.90 (34.5)	0.70 (0.93)	2198-H008-ERSx
VPH-B1003F-xxx2	4750	4750	3.49	3.43 (30.4)	17.70	10.33 (91.4)	1.36 (1.83)	2198-H015-ERSx
					20.20	11.80 (104)		2198-H025-ERSx
VPH-B1152F-xxx2	4500	4500	3.64	4.03 (35.7)	17.70	12.11 (107)	1.37 (1.84)	2198-H015-ERSx
					21.90	15.00 (133)		2198-H025-ERSx
VPH-B1153E-xxx2	3900	5000	5.02	5.13 (45.4)	17.70	10.93 (96.7)	1.27 (1.70)	2198-H015-ERSx
					34.60	21.40 (189)		2198-H040-ERSx
VPH-B1304E-xxx2	3500	3500	5.73	8.41 (74.5)	17.70	14.43 (128)	2.15 (2.88)	2198-H015-ERSx
					37.00	30.20 (267)		2198-H040-ERSx
VPH-B1653D-xxx2	3000	3000	10.41	18.67 (165)	28.30	27.14 (240)	3.16 (4.23)	2198-H025-ERSx
					76.60	73.50 (651)		2198-H070-ERSx

Performance specification data and curves reflect nominal system performance of a typical system with motor at 40 °C (104 °F) and drive at 40 °C (104 °F) ambient and rated line voltage. For additional information on ambient and line conditions, refer to Motion Analyzer software.

Bulletin VPH (brake) Motor Performance Specifications with Kinetix 5500 (400V-class operation) Drives

Rotary Motor Cat. No.	Rated Speed rpm	Speed, max rpm	System Continuous Stall Current A 0-pk	System Continuous Stall Torque N·m (lb·in)	System Peak Stall Current A 0-pk	System Peak Stall Torque N·m (lb·in)	Motor Rated Output kW (Hp)	Kinetix 5500 Drives (480V AC operation)
VPH-B0632T-xxx4	7200	8000	1.72	0.80 (7.1)	8.80	2.37 (21.0)	0.40 (0.54)	2198-H008-ERSx
					10.30	2.76 (24.4)		2198-H015-ERSx
VPH-B0633M-xxx4	6700	6700	1.39	1.01 (8.9)	8.75	4.16 (36.8)	0.50 (0.67)	2198-H008-ERSx
VPH-B0753F-xxx4	6600	6600	2.47	1.81 (16.0)	8.80	3.41 (30.2)	0.68 (0.92)	2198-H008-ERSx
					18.90	7.30 (64.6)		2198-H025-ERSx
VPH-B1001F-xxx4	5000	5000	1.56	1.42 (12.6)	7.80	3.90 (34.5)	0.68 (0.91)	2198-H008-ERSx
VPH-B1003F-xxx4	4750	4750	3.46	3.29 (29.1)	17.70	10.33 (91.4)	1.16 (1.56)	2198-H015-ERSx
					20.20	11.80 (104)		2198-H025-ERSx
VPH-B1152F-xxx4	4500	4500	3.89	4.03 (35.7)	17.70	12.11 (107)	1.37 (1.84)	2198-H015-ERSx
					21.90	15.00 (133)		2198-H025-ERSx
VPH-B1153E-xxx4	3900	5000	4.99	5.13 (45.4)	17.70	10.93 (96.7)	1.08 (1.45)	2198-H015-ERSx
					34.60	21.40 (189)		2198-H040-ERSx
VPH-B1304E-xxx4	3500	3500	5.85	8.24 (73.0)	17.70	14.43 (128)	1.76 (2.36)	2198-H015-ERSx
					37.00	30.20 (267)		2198-H040-ERSx
VPH-B1653D-xxx4	3000	3000	10.55	18.67 (165)	28.30	27.14 (240)	2.91 (3.91)	2198-H025-ERSx
					76.60	73.50 (651)		2198-H070-ERSx

Performance specification data and curves reflect nominal system performance of a typical system with motor at 40 °C (104 °F) and drive at 40 °C (104 °F) ambient and rated line voltage. For additional information on ambient and line conditions, refer to Motion Analyzer software.

Kinetix 5500 (400V-class operation) Drives/Kinetix VP Hygienic Stainless Steel Motor Curves

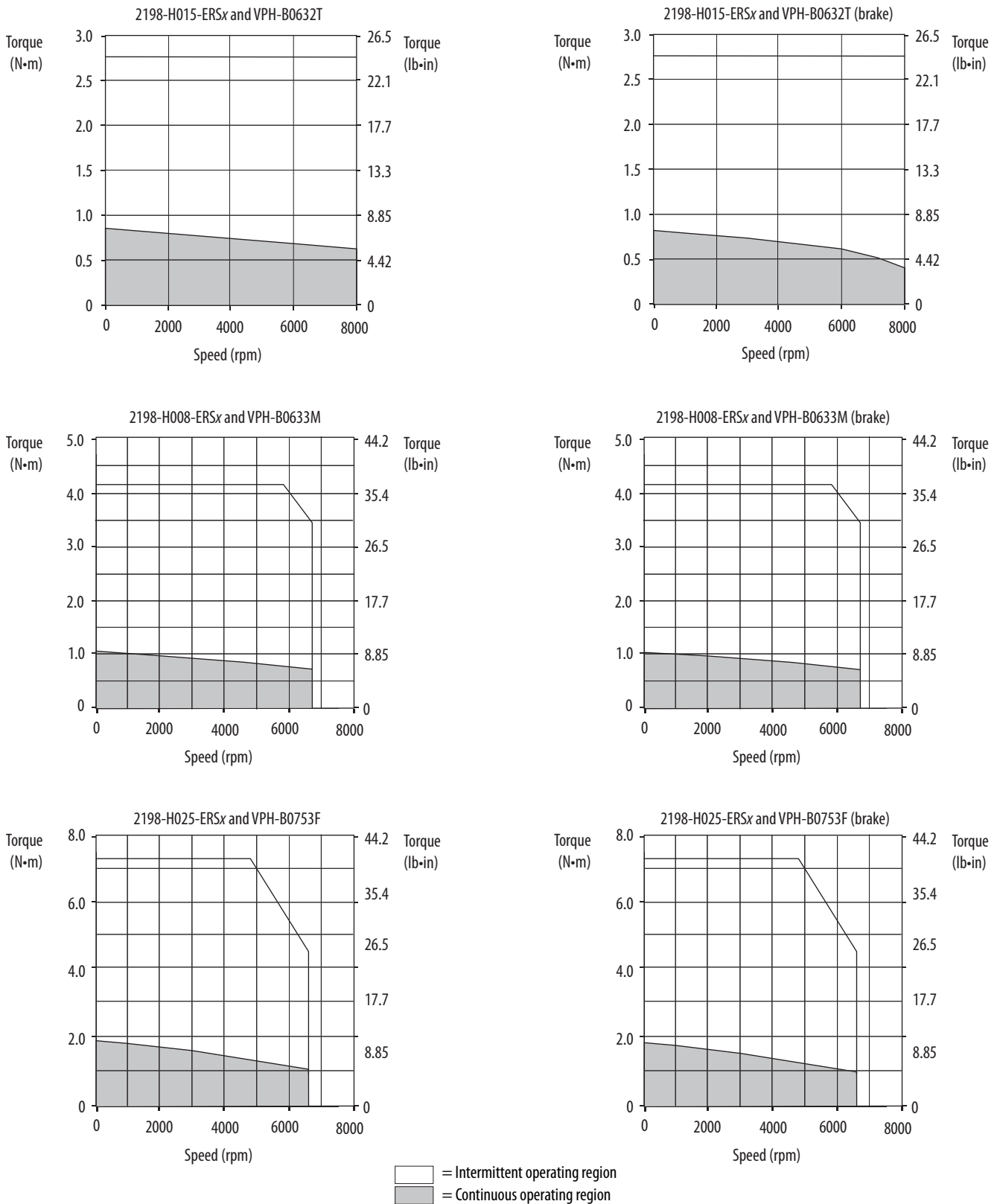

Kinetix 5500 (400V-class operation) Drives/Kinetix VP Hygienic Stainless Steel Motor Curves (continued)

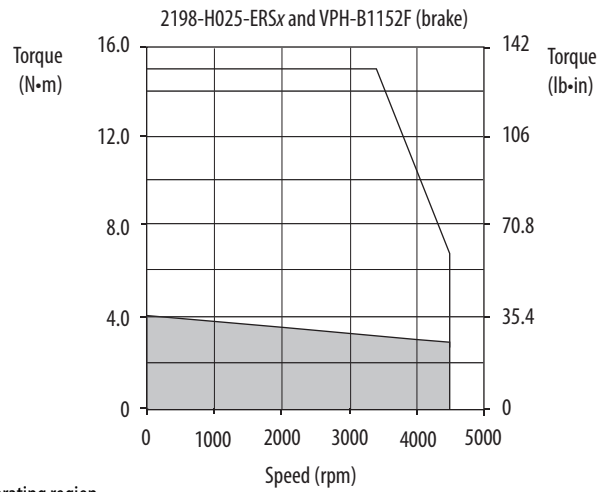
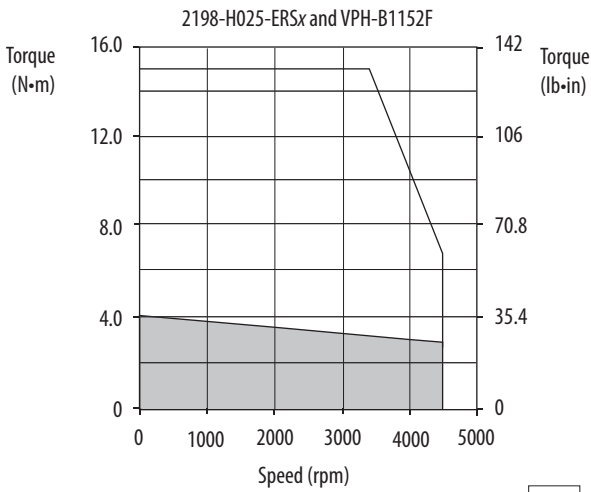
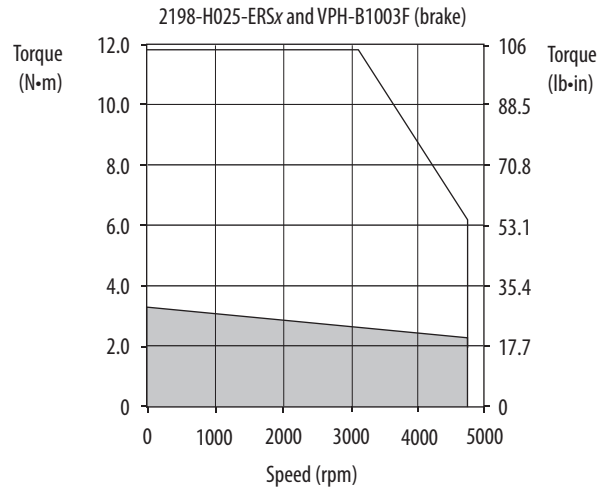
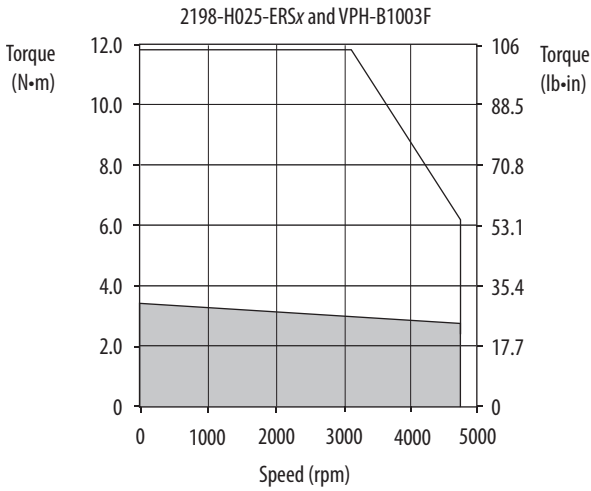
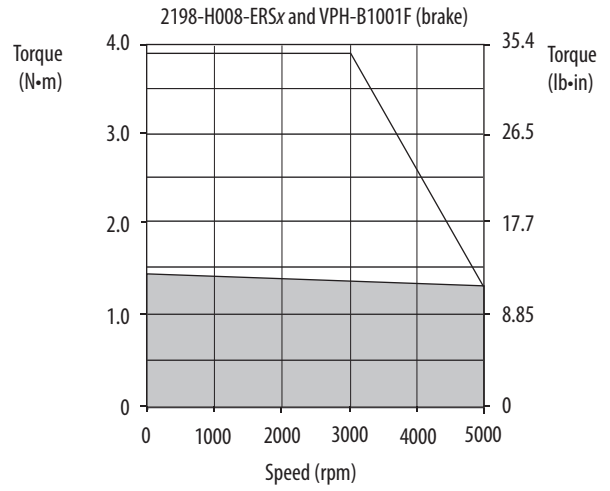
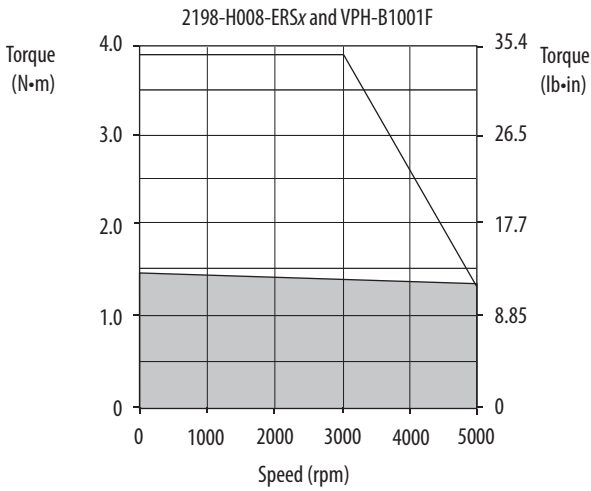

= Intermittent operating region
 = Continuous operating region

Kinetix 5500 (400V-class operation) Drives/Kinetix VP Hygienic Stainless Steel Motor Curves (continued)

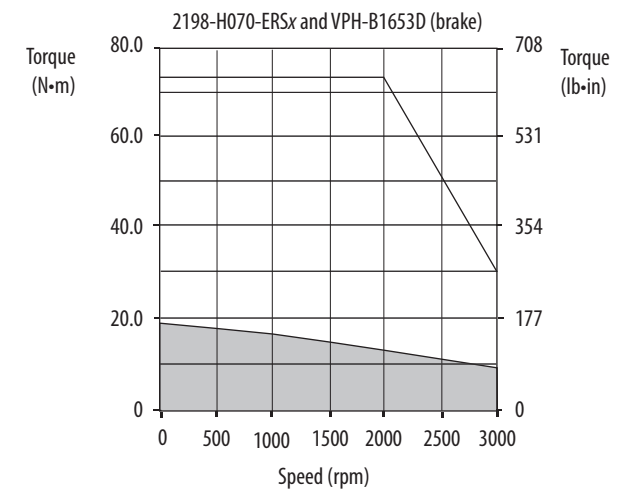
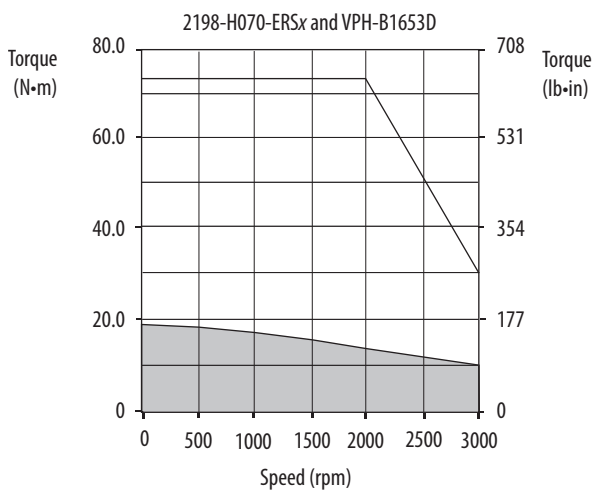
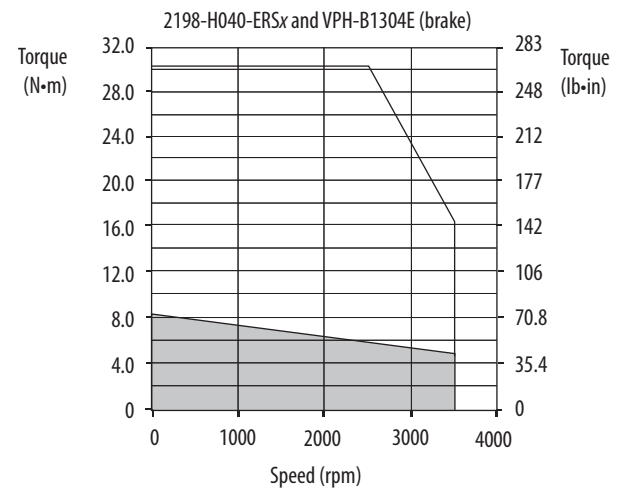
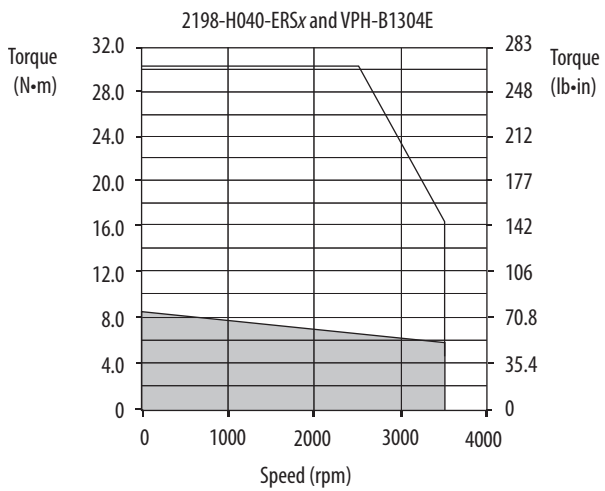
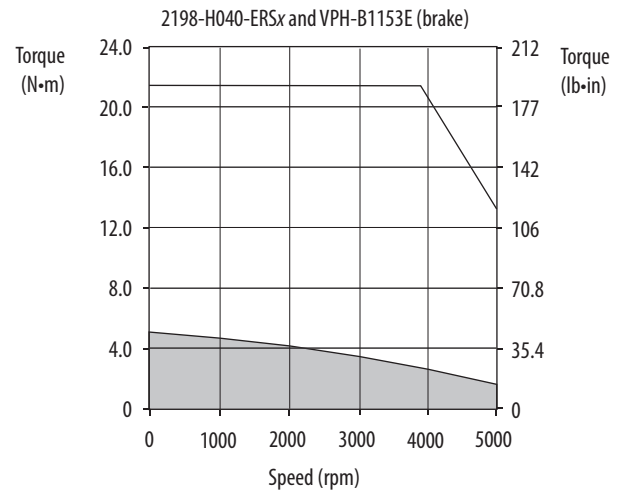
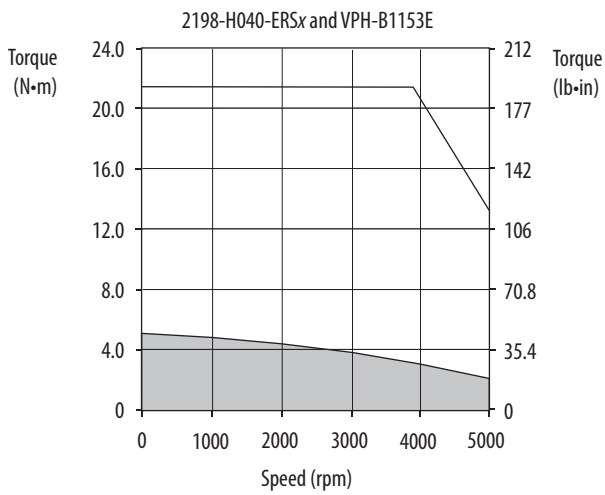

= Intermittent operating region
 = Continuous operating region

Kinetix 5500 (400V-class operation) Drives with Kinetix VP Stainless Steel Motors

This section provides system combination information for the Kinetix 5500 drives (with 400 and 480V, nominal input) when matched with Kinetix VP (400V-class) stainless-steel motors. Single cable catalog numbers, system performance specifications, and the optimum torque/speed curves are included.

Bulletin VPS Motor Cable Combinations

Rotary Motor (400V-class) Cat. No.	Motor Feedback Cable ⁽¹⁾	Feedback Type
VPS-B1304D	2090-CSWM1Dx-14AAxx (standard, non-flex) 2090-CSBM1Dx-14AFxx (continuous-flex)	Multi-turn or Single-turn Digital Encoder Feedback
VPS-B1653D		

(1) Use 2090-CSxM1DF or 2090-CSxM1DG cables. Cable length xx is in meters, 01 (3.3) . . . 50 (164) in 1.0 m (3.3 ft) increments. Refer to the Kinetix Motion Accessories Technical Data, publication [KNX-TD004](#), for cable specifications. For cable configuration illustrations and feature descriptions, by catalog number, refer to 2090-Series Single Motor Cable Overview beginning on [page 13](#).

Bulletin VPS Motor Performance Specifications with Kinetix 5500 (400V-class operation) Drives

Rotary Motor Cat. No.	Rated Speed rpm	Speed, max rpm	System Continuous Stall Current A (0-pk)	System Continuous Stall Torque N·m (lb·in)	System Peak Stall Current A 0-pk	System Peak Stall Torque N·m (lb·in)	Motor Rated Output kW (Hp)	Kinetix 5700 Drives (480V AC input)
VPS-B1304D	3000	3000	7.1	8.1 (72.0)	17.7	17.9 (158)	1.40 (1.9)	2198-H015-ERSx
					26.0	27.1 (240)		2198-H025-ERSx
VPS-B1653D	3000	3000	17.0	21.0 (186)	45.9	50.1 (443)	3.29 (4.4)	2198-H040-ERSx
					68.0	67.8 (600)		2198-H070-ERSx

Performance specification data and curves reflect nominal system performance of a typical system with the motor at 40 °C (104 °F) and the drive at 50 °C (122 °F) ambient, and rated line voltage. For additional information on ambient and line conditions, refer to Motion Analyzer software.

Kinetix 5500 (400V-class operation) Drives/Kinetix VP Stainless Steel Motor Curves

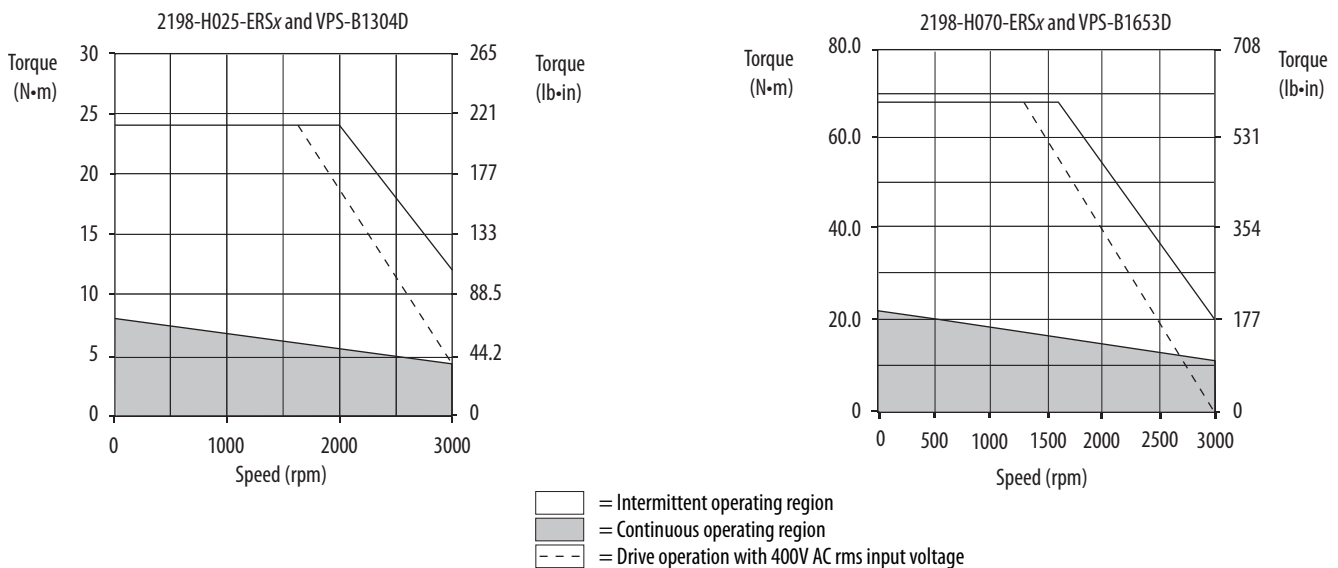

Kinetix 5500 (200V-class operation) Drives with MP-Series Low Inertia Motors

This section provides system combination information for the Kinetix 5500 drives (with 240V, nominal input) when matched with MP-Series (200V-class) low-inertia motors with absolute high-resolution encoders. Included are motor power/brake and feedback cable catalog numbers, system performance specifications, and the optimum torque/speed curves.

IMPORTANT These motors require the 2198-H2DCK (series B or later) feedback converter kit.

Kinetix 5500 servo drives are capable of 200V or 400V-class operation. These system performance tables and torque/speed curves reflect single-phase and three-phase drive operation with 200V-class motors; however, only 2198-H003-ERSx, 2198-H008-ERSx, and 2198-H015-ERSx drives are capable of single-phase operation.

IMPORTANT The MP-Series low-inertia motors on this page are equipped with DIN connectors (specified by 7, for example, MPL-A310P-xx7xAA) and are **not** compatible with cables designed for motors equipped with bayonet connectors (specified by 2, for example, MPL-A310P-xx2xAA). The motors with bayonet connectors are discontinued and require 2090-XXNxMP (bayonet) cables. For help with migration or to select bayonet transition cables, contact your Rockwell Automation sales representative.

Bulletin MPL Motor Cable Combinations

Rotary Motor (200V-class) Cat. No.	Motor Power/Brake Cable	Motor Feedback Cable ⁽¹⁾
MPL-A1510V-xx7xAA, MPL-A1520U-xx7xAA, MPL-A1530U-xx7xAA	2090-CPxM7DF-16AAxx (standard, non-flex) 2090-CPxM7DF-16AFxx (continuous-flex)	2090-CFBM7DF-CEAAxx ^{(2) (3)} (standard, non-flex) or 2090-CFBM7DF-CEAFxx (continuous-flex) Absolute High-resolution Feedback
MPL-A210V-xx7xAA, MPL-A220T-xx7xAA, MPL-A230P-xx7xAA		
MPL-A310F-xx7xAA, MPL-A310P-xx7xAA, MPL-A320H-xx7xAA, MPL-A320P-xx7xAA, MPL-A330P-xx7xAA		
MPL-A420P-xx7xAA, MPL-A430H-xx7xAA		
MPL-A4530F-xx7xAA, MPL-A4540C-xx7xAA		
MPL-A430P-xx7xAA		
MPL-A4530K-xx7xAA, MPL-A4540F-xx7xAA		
MPL-A4560F-xx7xAA		
MPL-A520K-xx7xAA	2090-CPxM7DF-10AAxx (standard, non-flex) 2090-CPxM7DF-10AFxx (continuous-flex)	

(1) Use the 2198-H2DCK (series B or later) Hiperface-to-DSL feedback converter kit with flying-lead cables on the drive end. Refer to Required Drive Accessories on [page 8](#).

(2) Applies to Kinetix 5500 drives and MPL-A3xxx-M/S through MPL-A5xxx-M/S motors with absolute high-resolution feedback.

(3) Applies to Kinetix 5500 drives and MPL-A15xxx-V/E through MPL-A2xxx-V/E motors with absolute high-resolution feedback.

For cable configuration illustrations and feature descriptions, by catalog number, refer to 2090-Series Motor Power/Brake and Feedback Cables Overview beginning on [page 14](#). Motor-end connector kits are available for motor power/brake and feedback cables. Refer to the Kinetix Motion Accessories Technical Data, publication [KNX-TD004](#), for more information. Cable length xx is in meters. Refer to the Kinetix Motion Accessories Technical Data, publication [KNX-TD004](#), for standard cable lengths.

Bulletin MPL Motor Performance Specifications with Kinetix 5500 (200V-class operation) Drives

Rotary Motor Cat. No.	Rated Speed rpm	Speed, max rpm	System Continuous Stall Current A 0-pk	System Continuous Stall Torque N·m (lb·in)	System Peak Stall Current A 0-pk	System Peak Stall Torque N·m (lb·in)	Motor Rated Output kW	Kinetix 5500 (240V AC input)
MPL-A1510V	8000	8000	1.05	0.26 (2.3)	3.40	0.77 (6.8)	0.16	2198-H003-ERSx
MPL-A1520U	7000	7000	1.80	0.49 (4.3)	6.10	1.58 (13.9)	0.27	2198-H008-ERSx
MPL-A1530U	7000	7000	2.82	0.90 (8.0)	10.1	2.82 (24.9)	0.39	2198-H015-ERSx
MPL-A210V	8000	8000	3.09	0.55 (4.8)	10.2	1.52 (13.4)	0.37	2198-H015-ERSx
MPL-A220T	6000	6000	4.54	1.61 (14.2)	15.5	4.74 (41.9)	0.62	2198-H015-ERSx
MPL-A230P	5000	5000	5.40	2.10 (18.6)	23.0	8.2 (73.0)	0.86	2198-H025-ERSx
MPL-A310F	3000	3000	3.24	1.58 (14.0)	8.80	3.44 (30.4)	0.46	2198-H008-ERSx
					9.30	3.61 (31.9)		2198-H015-ERSx
MPL-A310P	5000	5000	4.91	1.58 (14.0)	14.0	3.61 (31.9)	0.73	2198-H015-ERSx
MPL-A320H	3500	3500	6.10	3.05 (27.0)	19.3	7.91 (70.0)	1.0	2198-H025-ERSx
MPL-A320P	5000	5000	9.00	3.05 (27.0)	28.3	7.60 (44.8)	1.3	2198-H025-ERSx
					29.5	7.91 (70.0)		2198-H040-ERSx
MPL-A330P	5000	5000	12.0	4.18 (37.0)	38.0	11.1 (98.2)	1.8	2198-H040-ERSx
MPL-A420P	5000	5000	12.9	4.79 (42.3)	46.0	13.6 (119)	2.0	2198-H040-ERSx
MPL-A430H	3500	3500	12.2	6.21 (55.0)	45.0	19.8 (175)	1.8	2198-H040-ERSx
MPL-A430P	5000	5000	16.80	5.99 (52.9)	67.0	19.8 (175)	2.2	2198-H070-ERSx
MPL-A4530F	2800	2800	13.40	8.36 (74.0)	42.0	20.3 (179)	1.9	2198-H040-ERSx
MPL-A4530K	4000	4000	19.50	8.13 (71.9)	62.0	20.3 (179)	2.5	2198-H070-ERSx
MPL-A4540C	1500	1500	9.55	10.30 (91.1)	28.3	26.23 (232)	1.5	2198-H025-ERSx
					29.0	27.1 (239)		2198-H040-ERSx
MPL-A4540F	3000	3000	18.40	10.19 (90.1)	45.9	22.09 (195)	2.6	2198-H040-ERSx
					58.0	27.1 (239)		2198-H070-ERSx
MPL-A4560F	3000	3000	22.0	14.1 (125)	66.0	34.4 (305)	3.0	2198-H070-ERSx
MPL-A520K	4000	4000	15.0	10.77 (95.2)	65.0	24.2 (214)	3.5	2198-H070-ERSx

Performance specification data and curves reflect nominal system performance of a typical system with motor at 40 °C (104 °F) and drive at 40 °C (104 °F) ambient and rated line voltage. For additional information on ambient and line conditions, refer to Motion Analyzer software.

Kinetix 5500 (200V-class operation) Drives/MP-Series Low Inertia Motor Curves

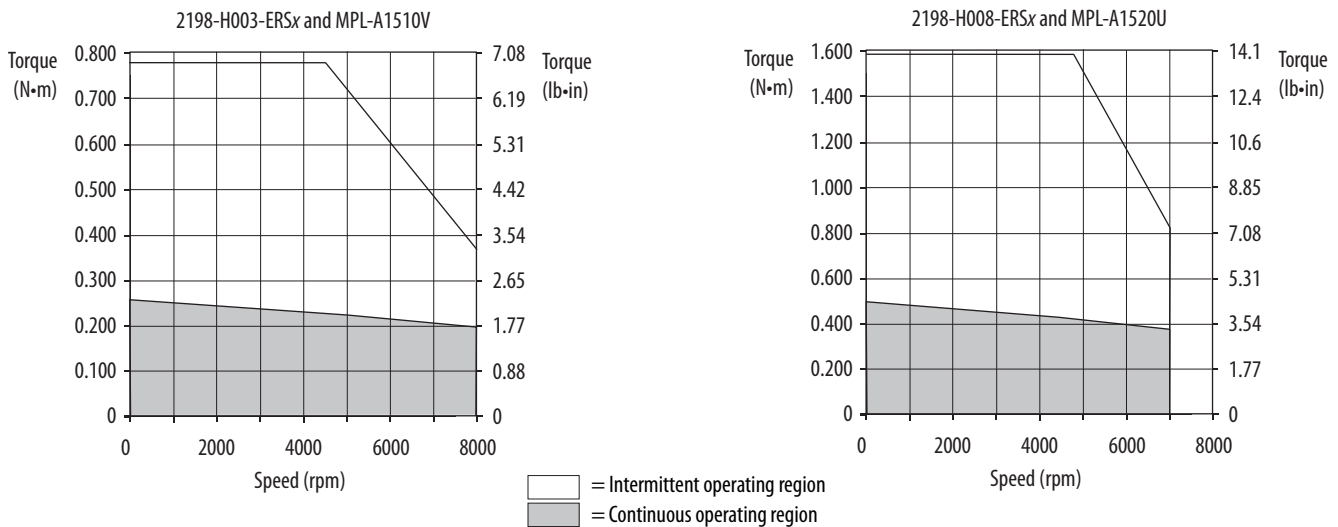

Kinetix 5500 (200V-class operation) Drives/MP-Series Low Inertia Motor Curves (continued)

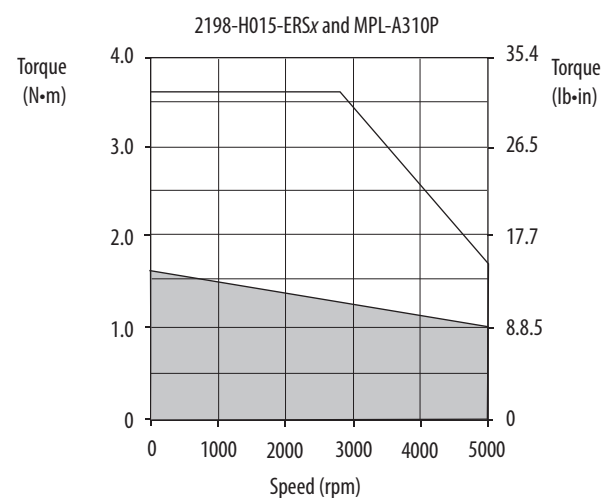
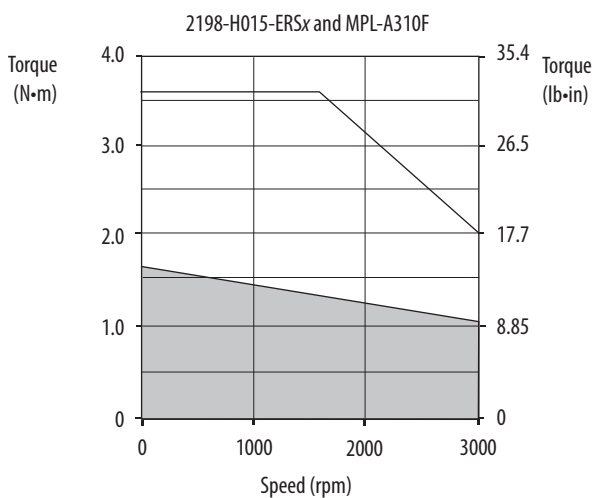
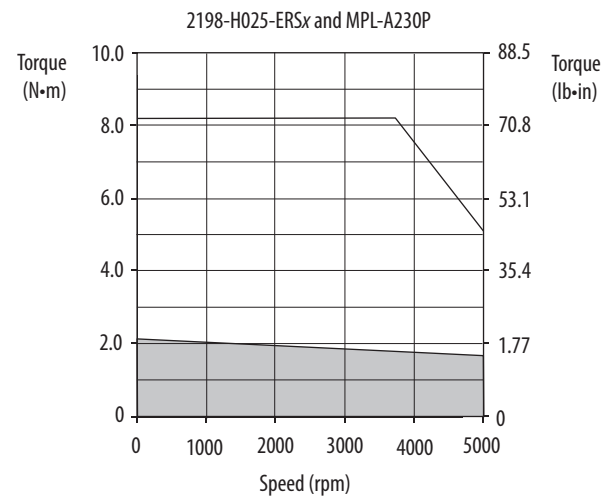
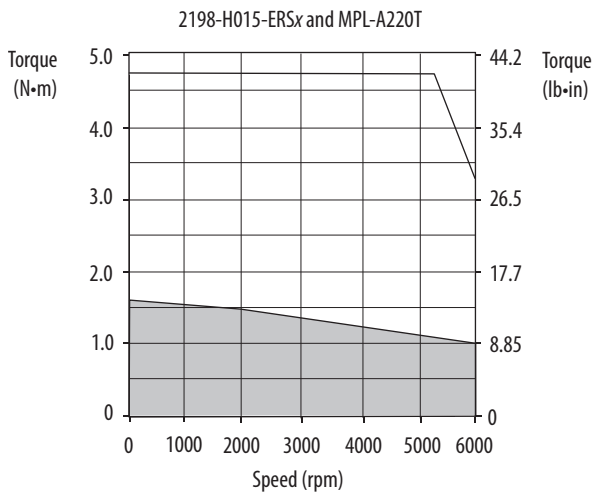
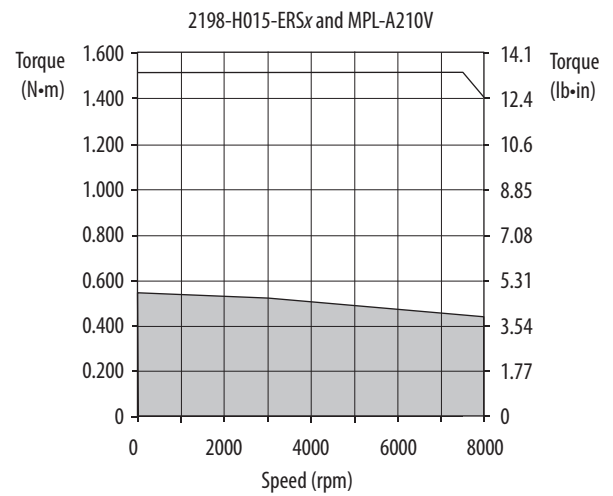
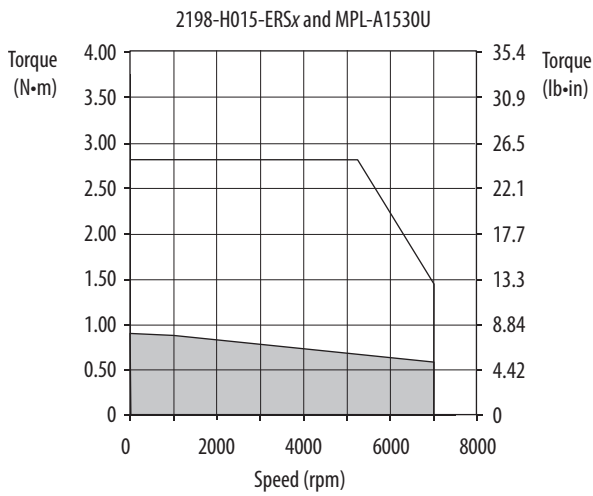

= Intermittent operating region
 = Continuous operating region

Kinetix 5500 (200V-class operation) Drives/MP-Series Low Inertia Motor Curves (continued)

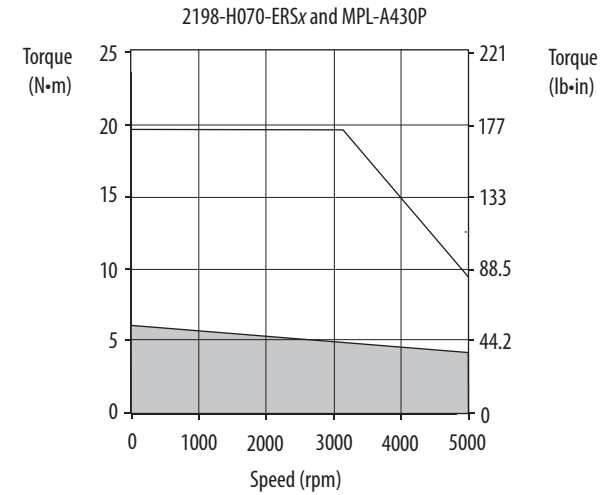
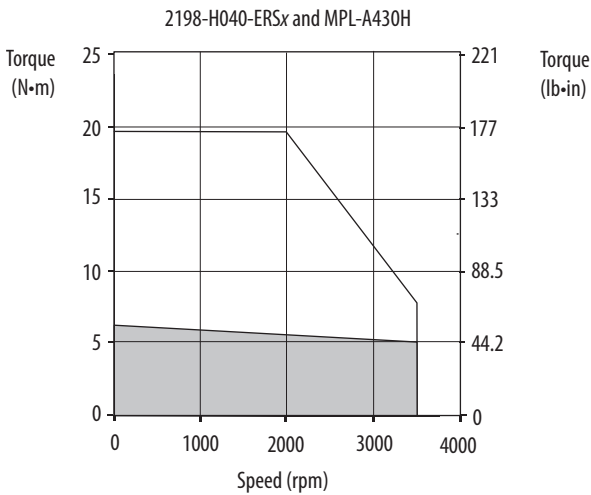
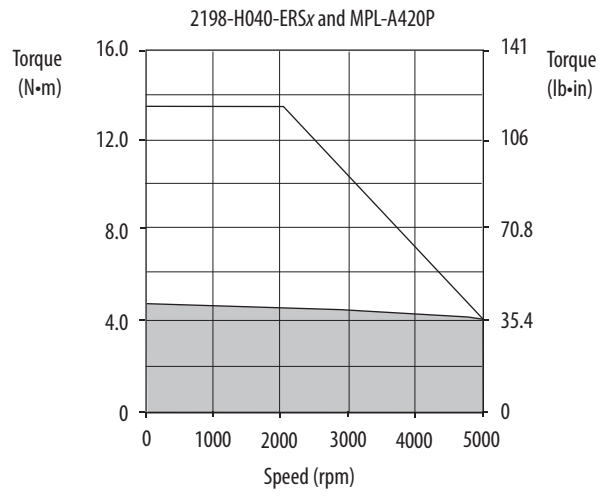
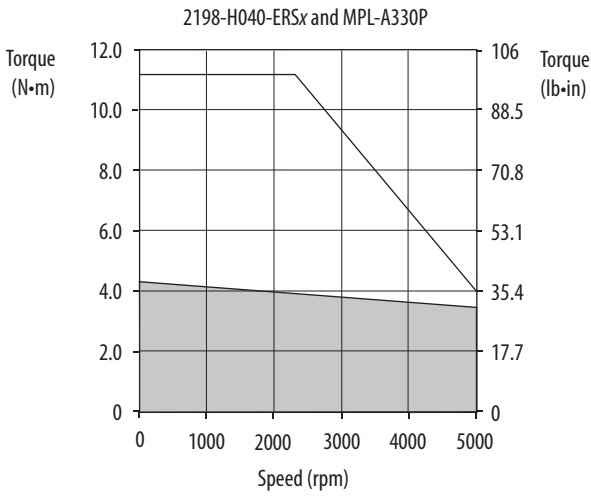
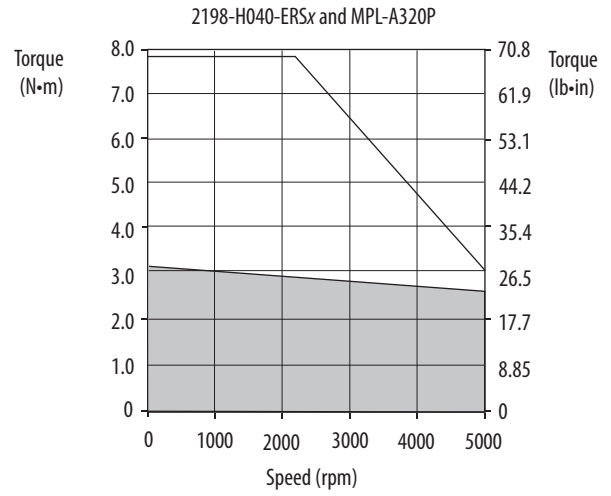
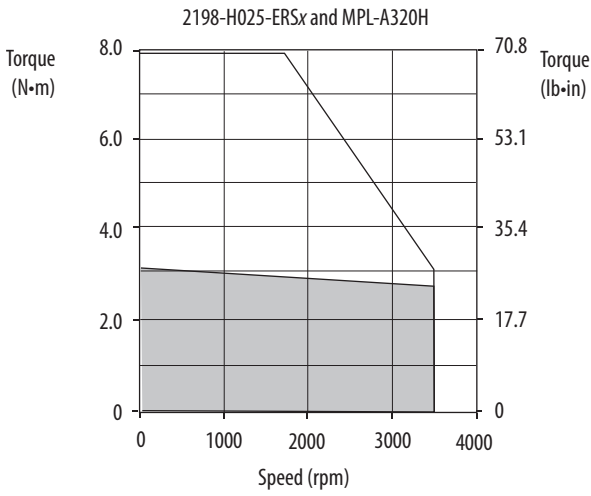

= Intermittent operating region
 = Continuous operating region

Kinetix 5500 (200V-class operation) Drives/MP-Series Low Inertia Motor Curves (continued)

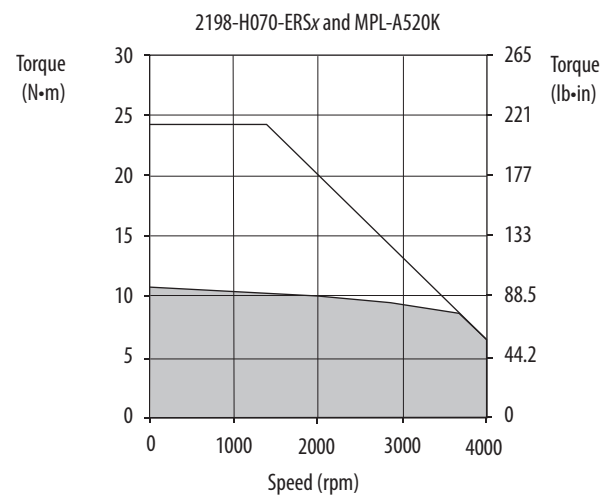
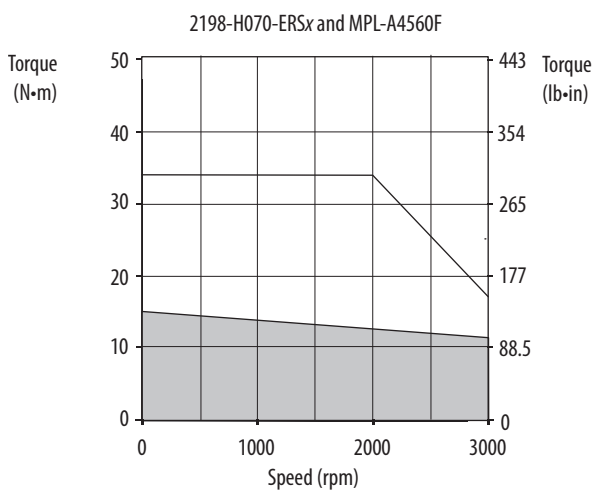
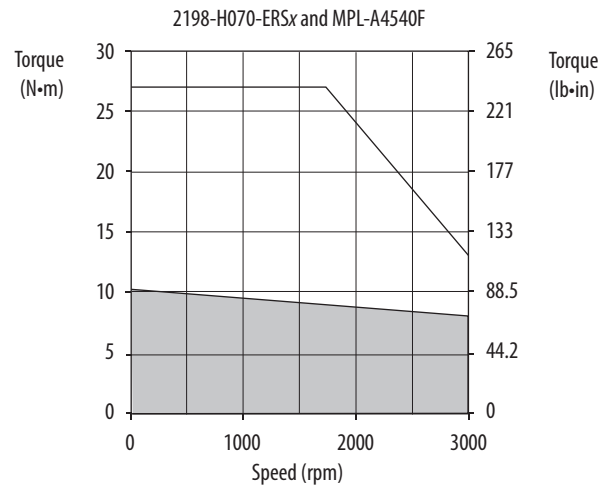
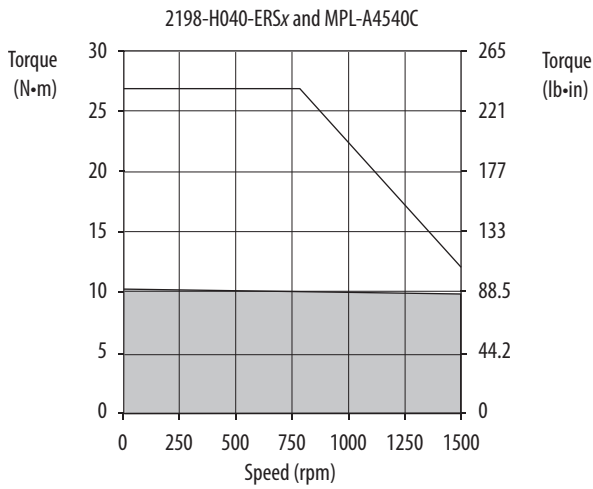
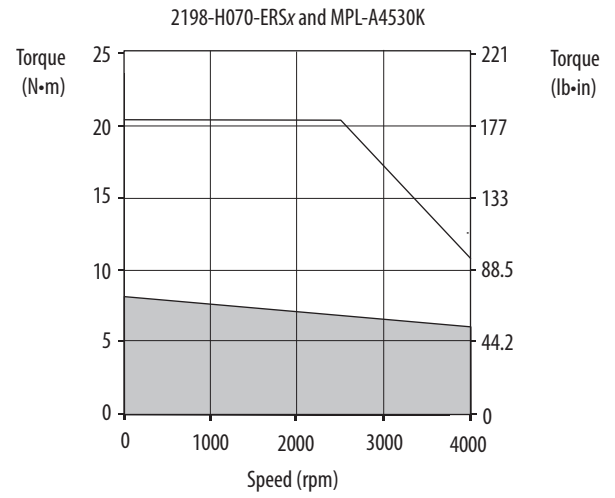
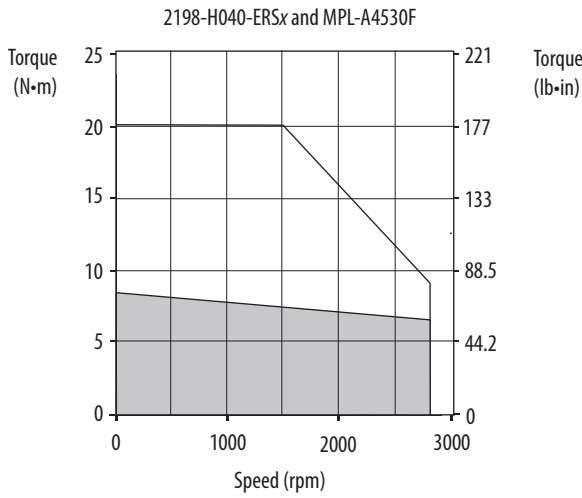

= Intermittent operating region
 = Continuous operating region

Kinetix 5500 (400V-class operation) Drives with MP-Series Low Inertia Motors

This section provides system combination information for the Kinetix 5500 drives (with 400 and 480V, nominal input) when matched with MP-Series (400V-class) low-inertia motors with absolute high-resolution encoders. Included are motor power/brake and feedback cable catalog numbers, system performance specifications, and the optimum torque/speed curves.

IMPORTANT These motors require the 2198-H2DCK (series B or later) feedback converter kit.

IMPORTANT The MP-Series low-inertia motors on this page are equipped with DIN connectors (specified by 7, for example, MPL-A310P-xx7xAA) and are **not** compatible with cables designed for motors equipped with bayonet connectors (specified by 2, for example, MPL-A310P-xx2xAA). The motors with bayonet connectors are discontinued and require 2090-XXNxMP (bayonet) cables. For help with migration or to select bayonet transition cables, contact your Rockwell Automation sales representative.

Bulletin MPL Motor Cable Combinations

Rotary Motor (400V-class) Cat. No.	Motor Power/Brake Cable	Motor Feedback Cable ⁽¹⁾
MPL-B1510V-xx7xAA, MPL-B1520U-xx7xAA, MPL-B1530U-xx7xAA	2090-CPxM7DF-16AAxx (standard, non-flex) 2090-CPxM7DF-16AFxx (continuous-flex)	2090-CFBM7DF-CEAAxx ^{(2) (3)} (standard, non-flex) 2090-CFBM7DF-CEAFxx (continuous-flex) Absolute High-resolution Feedback
MPL-B210V-xx7xAA, MPL-B220T-xx7xAA, MPL-B230P-xx7xAA		
MPL-B310P-xx7xAA, MPL-B320P-xx7xAA, MPL-B330P-xx7xAA		
MPL-B420P-xx7xAA, MPL-B430P-xx7xAA		
MPL-B4530F-xx7xAA, MPL-B4530K-xx7xAA, MPL-B4540F-xx7xAA, MPL-B4560F-xx7xAA		
MPL-B520K-xx7xAA	2090-CPxM7DF-14AAxx (standard, non-flex) 2090-CPxM7DF-14AFxx (continuous-flex)	
MPL-B540D-xx7xAA, MPL-B540K-xx7xAA, MPL-B560F-xx7xAA		
MPL-B580F-xx7xAA, MPL-B580J-xx7xAA, MPL-B640F-xx7xAA		

(1) Use the 2198-H2DCK (series B or later) Hiperface-to-DSL feedback converter kit with flying-lead cables on the drive end. Refer to Required Drive Accessories on [page 8](#).

(2) Applies to Kinetix 5500 drives and MPL-B3xxx-M/S through MPL-B6xxx-M/S motors with absolute high-resolution feedback.

(3) Applies to Kinetix 5500 drives and MPL-B15xxx-V/E through MPL-B2xxx-V/E motors with absolute high-resolution feedback.

For cable configuration illustrations and feature descriptions, by catalog number, refer to 2090-Series Motor Power/Brake and Feedback Cables Overview beginning on [page 14](#).

Motor-end connector kits are available for motor power/brake and feedback cables. Refer to the Kinetix Motion Accessories Technical Data, publication [KNX-TD004](#), for more information.

Cable length xx is in meters. Refer to the Kinetix Motion Accessories Technical Data, publication [KNX-TD004](#), for standard cable lengths.

Bulletin MPL Motor Performance Specifications with Kinetix 5500 (400V-class operation) Drives

Rotary Motor Cat. No.	Rated Speed rpm	Speed, max rpm	System Continuous Stall Current A 0-pk	System Continuous Stall Torque N·m (lb·in)	System Peak Stall Current A 0-pk	System Peak Stall Torque N·m (lb·in)	Motor Rated Output kW	Kinetix 5500 (480V AC input)
MPL-B1510V	8000	8000	0.95	0.26 (2.3)	3.10	0.77 (6.8)	0.16	2198-H003-ERSx
MPL-B1520U	7000	7000	1.80	0.49 (4.3)	6.10	1.58 (13.9)	0.27	2198-H008-ERSx
MPL-B1530U	7000	7000	2.0	0.90 (8.0)	7.20	2.82 (24.9)	0.39	2198-H008-ERSx
MPL-B210V	8000	8000	1.75	0.55 (4.9)	5.80	1.52 (13.4)	0.37	2198-H008-ERSx
MPL-B220T	6000	6000	3.30	1.61 (14.2)	8.80	3.67 (32.5)	0.62	2198-H008-ERSx
					11.3	4.74 (41.9)		2198-H015-ERSx
MPL-B230P	5000	5000	2.60	2.10 (18.6)	8.80	6.39 (56.6)	0.86	2198-H008-ERSx
					11.3	8.20 (73.0)		2198-H015-ERSx
MPL-B310P	5000	5000	2.4	1.6 (14.1)	7.10	3.6 (32)	0.77	2198-H008-ERSx
MPL-B320P	5000	5000	4.5	3.10 (27)	14.0	8.2 (72.5)	1.5	2198-H015-ERSx
MPL-B330P	5000	5000	6.1	4.18 (37)	17.7	10.4 (92.0)	1.8	2198-H015-ERSx
					19.0	11.1 (98)		2198-H025-ERSx
MPL-B420P	5000	5000	6.3	4.74 (42)	17.7	11.3 (100)	1.9	2198-H015-ERSx
					22.0	13.5 (119)		2198-H025-ERSx
MPL-B430P	5000	5000	9.2	6.55 (58)	28.3	17.6 (156)	2.2	2198-H025-ERSx
					32.0	19.8 (175)		2198-H040-ERSx
MPL-B4530F	3000	3000	6.7	8.36 (74)	17.7	17.7 (157)	2.1	2198-H015-ERSx
					21.0	20.3 (180)		2198-H025-ERSx
MPL-B4530K	4000	4000	9.9	8.25 (73)	28.3	18.7 (166)	2.6	2198-H025-ERSx
					31.0	20.3 (179)		2198-H040-ERSx
MPL-B4540F	3000	3000	9.1	10.20 (90)	28.3	26.2 (232)	2.6	2198-H025-ERSx
					29.0	27.1 (240)		2198-H040-ERSx
MPL-B4560F	3000	3000	11.3	13.85 (123)	28.3	28.4 (251)	3.2	2198-H025-ERSx
			11.8	14.0 (124)	36.0	34.4 (304)		2198-H040-ERSx
MPL-B520K	3500	4000	11.3	10.4 (92)	28.3	20.6 (182)	3.5	2198-H025-ERSx
			11.5	10.7 (95)	33.0	23.2 (205)		2198-H040-ERSx
MPL-B540D	2000	2000	10.5	19.4 (172)	23.0	41.0 (362)	3.4	2198-H025-ERSx
MPL-B540K	4000	4000	20.4	19.4 (171)	60.0	48.6 (430)	5.4	2198-H070ERSx
MPL-B560F	3000	3000	20.6	26.8 (237)	68.0	67.8 (600)	5.5	2198-H070-ERSx
MPL-B580F	3000	3000	26.0	34.0 (300)	81.3	78.9 (698)	7.1	2198-H070-ERSx
MPL-B580J	3800	3800	32.0	34.0 (301)	81.3	71.52 (633)	7.9	2198-H070-ERSx
MPL-B640F	2000	3000	32.0	36.7 (325)	65.0	72.3 (640)	6.1	2198-H070-ERSx

Performance specification data and curves reflect nominal system performance of a typical system with motor at 40 °C (104 °F) and drive at 40 °C (104 °F) ambient and rated line voltage. For additional information on ambient and line conditions, refer to Motion Analyzer software.

Kinetix 5500 (400V-class operation) Drives/MP-Series Low Inertia Motor Curves

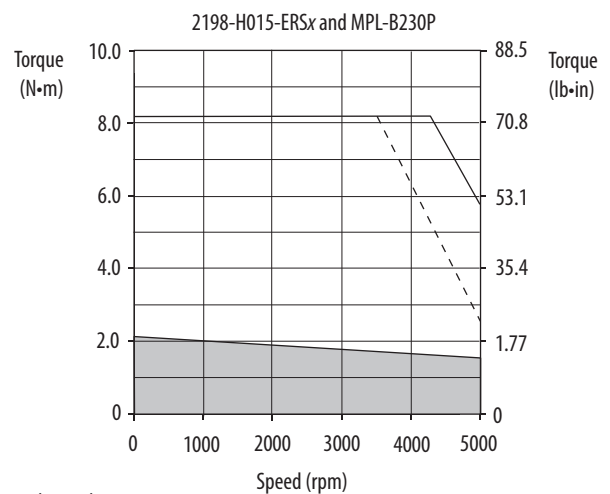
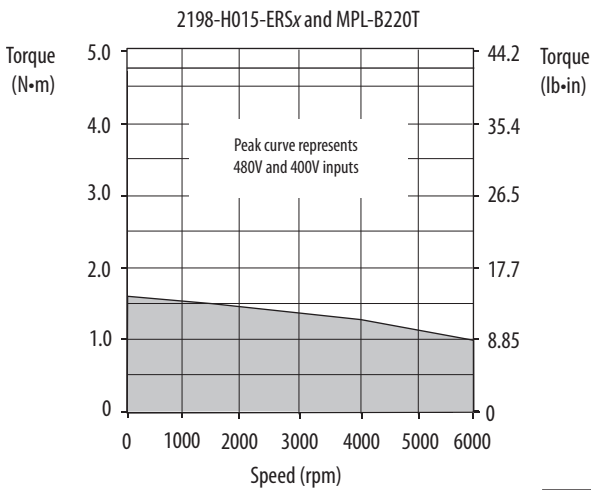
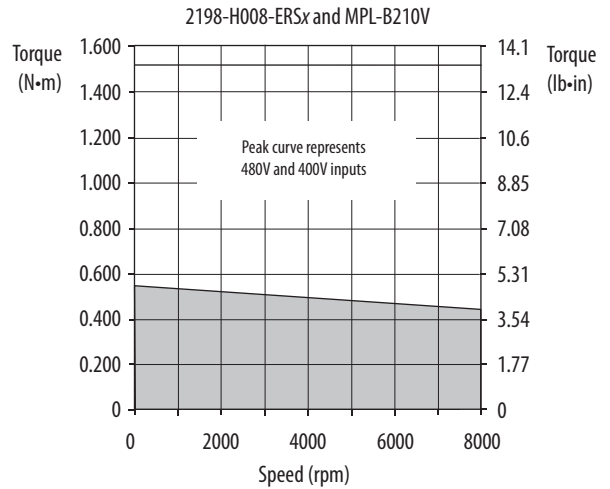
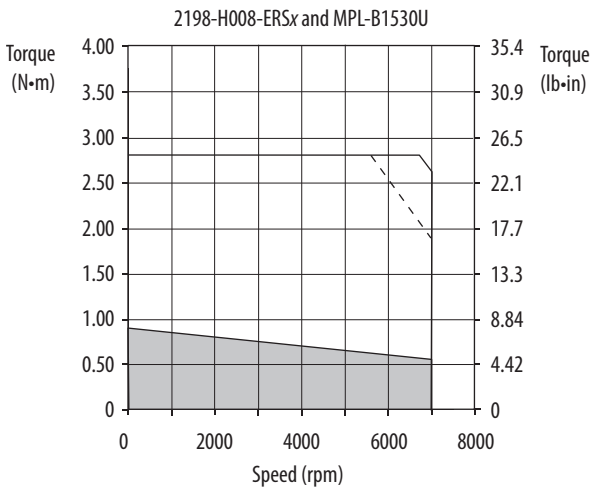
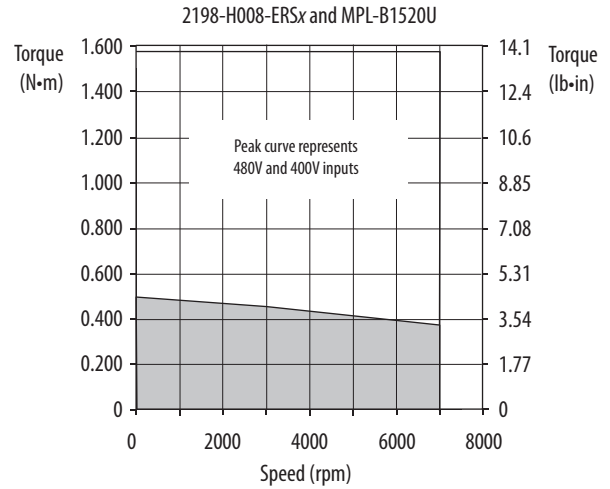
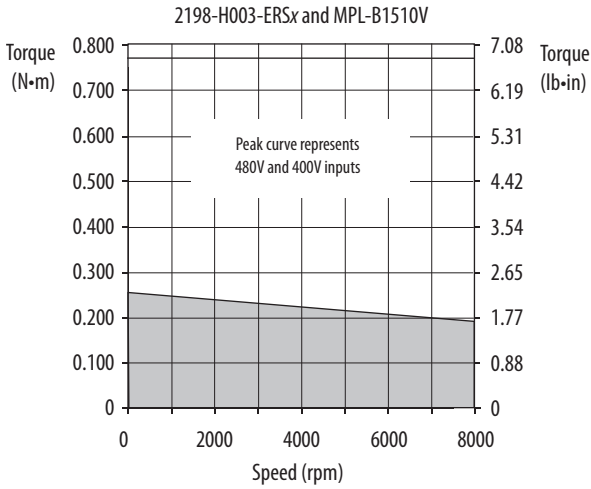

- = Intermittent operating region
- = Continuous operating region
- = Drive operation with 400V AC rms input voltage

Kinetix 5500 (400V-class operation) Drives/MP-Series Low Inertia Motor Curves (continued)

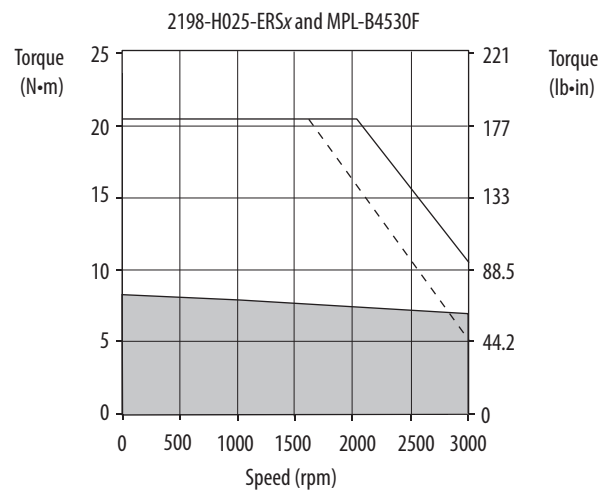
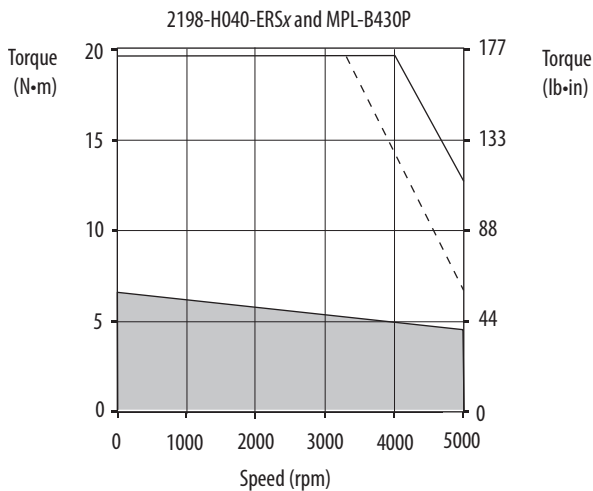
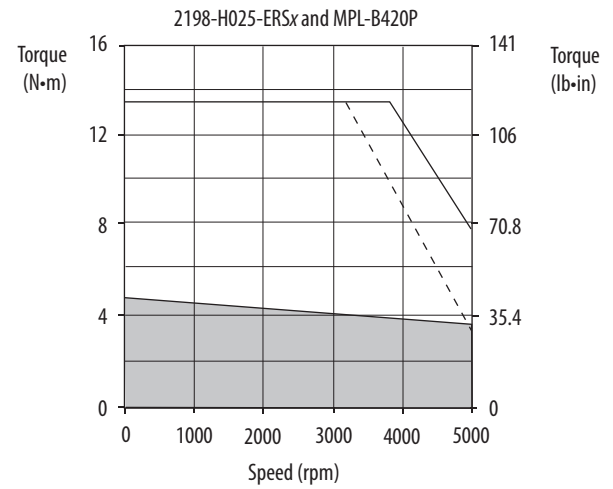
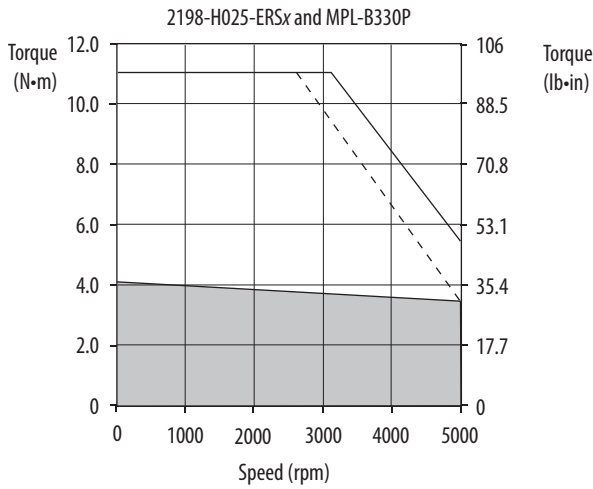
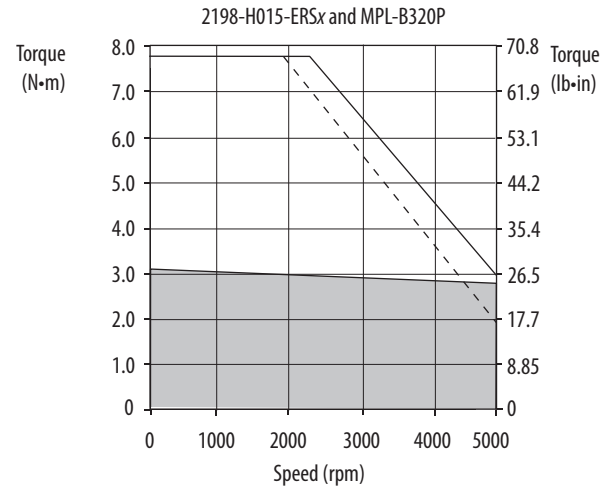
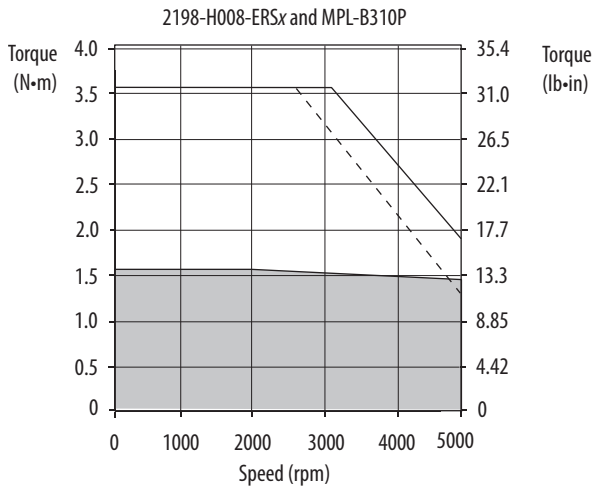

- = Intermittent operating region
- = Continuous operating region
- = Drive operation with 400V AC rms input voltage

Kinetix 5500 (400V-class operation) Drives/MP-Series Low Inertia Motor Curves (continued)

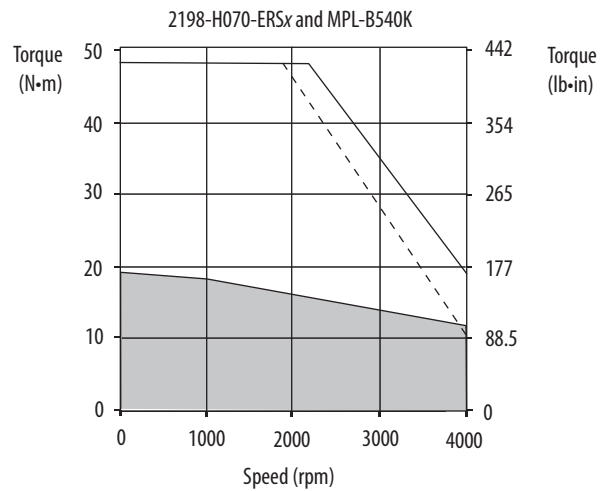
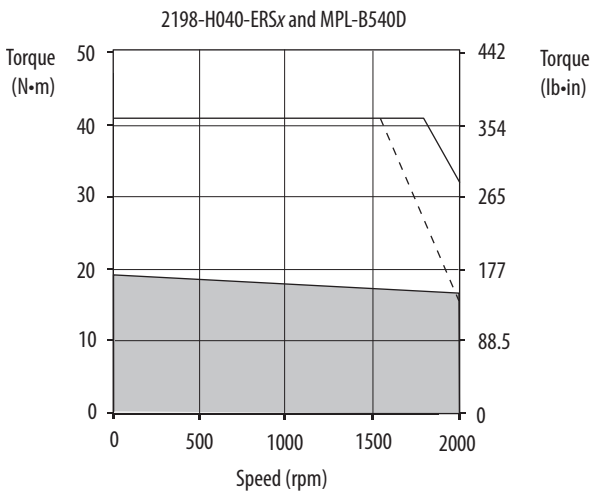
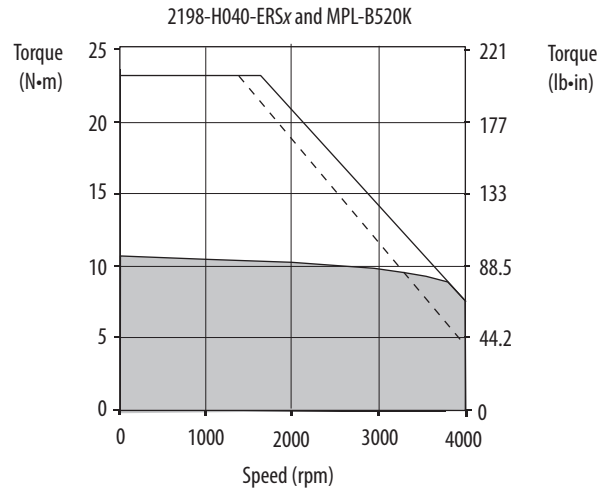
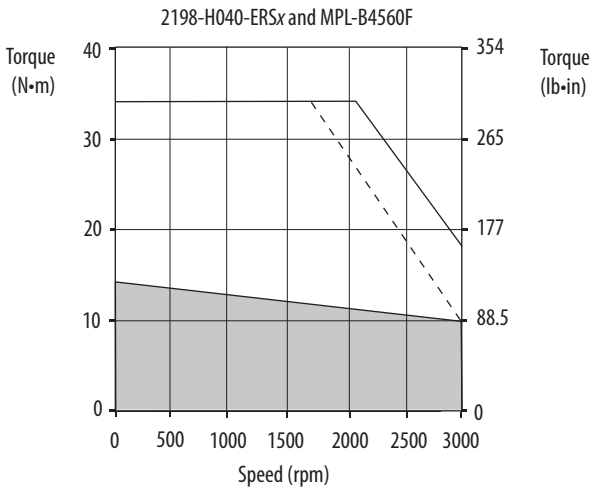
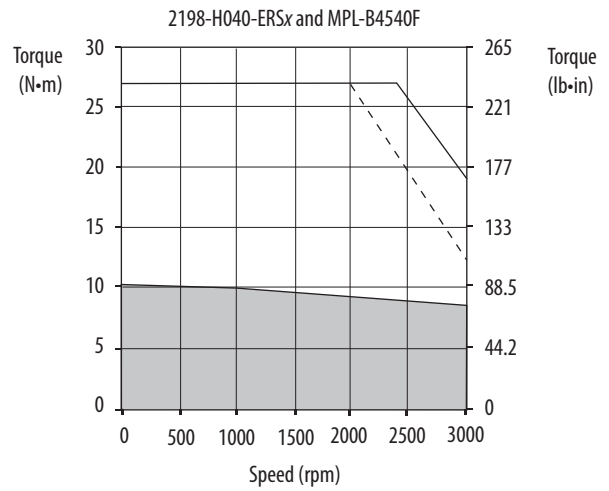
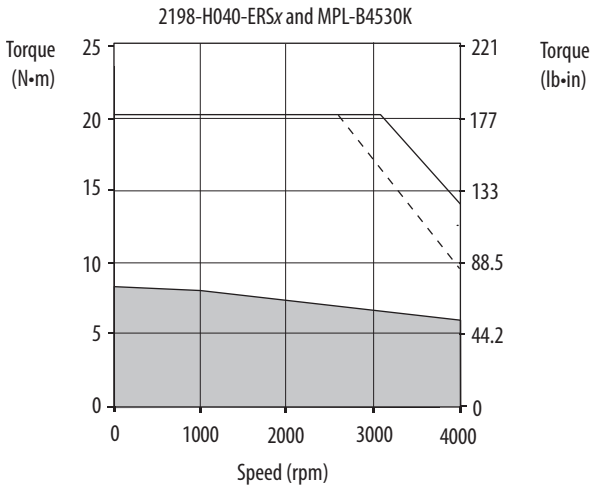

- = Intermittent operating region
- = Continuous operating region
- = Drive operation with 400V AC rms input voltage

Kinetix 5500 (400V-class operation) Drives/MP-Series Low Inertia Motor Curves (continued)

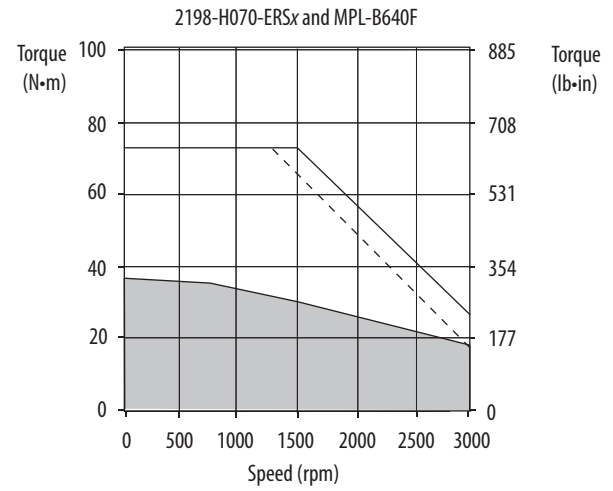
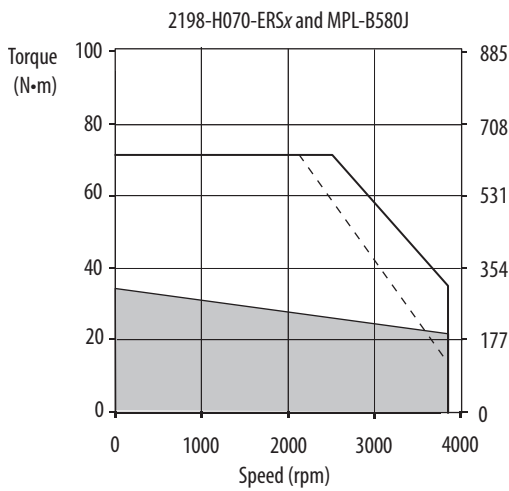
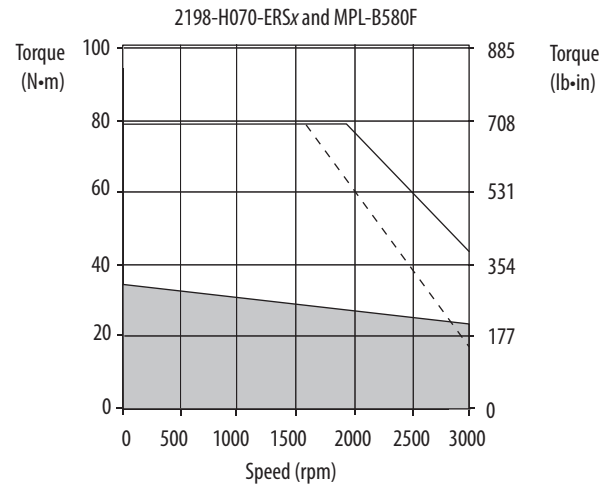
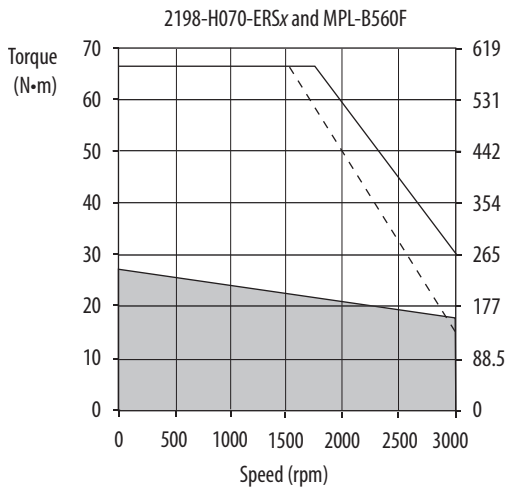

- = Intermittent operating region
- = Continuous operating region
- = Drive operation with 400V AC rms input voltage

Kinetix 5500 (200V-class operation) Drives with MP-Series Medium Inertia Motors

This section provides system combination information for the Kinetix 5500 drives (with 240V, nominal input) when matched with MP-Series (200V-class) medium-inertia motors with absolute high-resolution encoders. Included are motor power/brake and feedback cable catalog numbers, system performance specifications, and the optimum torque/speed curves.

IMPORTANT These motors require the 2198-H2DCK (series B or later) feedback converter kit.

Kinetix 5500 servo drives are capable of 200V or 400V-class operation. These system performance tables and torque/speed curves reflect single-phase and three-phase drive operation with 200V-class motors; however, only 2198-H003-ERSx, 2198-H008-ERSx, and 2198-H015-ERSx drives are capable of single-phase operation.

Bulletin MPM Motor Cable Combinations

Rotary Motor (200V-class) Cat. No.	Motor Power/Brake Cable	Motor Feedback Cable ⁽¹⁾
MPM-A1151M, MPM-A1152F, MPM-A1153F	2090-CPxM7DF-16AAxx (standard, non-flex) 2090-CPxM7DF-16AFxx (continuous-flex)	2090-CFBM7DF-CEAAxx (standard, non-flex) ⁽²⁾ 2090-CFBM7DF-CEAFxx (continuous-flex) Absolute High-resolution Feedback
MPM-A1302F	2090-CPxM7DF-14AAxx (standard, non-flex) 2090-CPxM7DF-14AFxx (continuous-flex)	
MPM-A1304F	2090-CPxM7DF-12AAxx (standard, non-flex)	
MPM-A1651F	2090-CPxM7DF-10AAxx (standard, non-flex) 2090-CPxM7DF-10AFxx (continuous-flex)	

(1) Use the 2198-H2DCK (series B or later) Hiperface-to-DSL feedback converter kit with flying-lead cables on the drive end. Refer to Required Drive Accessories on [page 8](#).

(2) Applies to Kinetix 5500 drives and MPM-A1xxx-M/S motors with absolute high-resolution feedback.

For cable configuration illustrations and feature descriptions, by catalog number, refer to 2090-Series Motor Power/Brake and Feedback Cables Overview beginning on [page 14](#). Motor-end connector kits are available for motor power/brake and feedback cables. Refer to the Kinetix Motion Accessories Technical Data, publication [KNX-TD004](#), for more information. Cable length xx is in meters. Refer to the Kinetix Motion Accessories Technical Data, publication [KNX-TD004](#), for standard cable lengths.

Bulletin MPM Motor Performance Specifications with Kinetix 5500 (200V-class) Drives

Rotary Motor Cat. No.	Base Speed rpm	Rated Speed rpm	Speed, max rpm	System Continuous Stall Current A 0-pk	System Continuous Stall Torque N·m (lb·in)	System Peak Stall Current A 0-pk	System Peak Stall Torque N·m (lb·in)	Motor Rated Output kW	Kinetix 5500 Drives (240V AC input)
MPM-A1151M	4500	5000	6000	7.65	2.3 (20.3)	28.3	6.2 (54.9)	0.90	2198-H025-ERSx
						30.5	6.6 (58.4)		2198-H040-ERSx
MPM-A1152F	3000	4000	5000	11.30	4.4 (38.9)	28.3	9.4 (83.2)	1.40	2198-H025-ERSx
				11.93	4.7 (41.6)	44.8	13.5 (119)		2198-H040-ERSx
MPM-A1153F	3000	4000	5000	16.18	6.5 (57.5)	45.9	15.3 (135)	1.45	2198-H040-ERSx
						64.5	19.8 (175)		2198-H070-ERSx
MPM-A1302F	3000	4000	4500	17.28	6.6 (58.4)	45.9	12.7 (112)	1.65	2198-H040-ERSx
						50.2	13.5 (119)		2198-H070-ERSx
MPM-A1304F	3000	3500	4000	19.65	9.3 (82.0)	45.9	18.6 (165)	2.20	2198-H040-ERSx
						48.3	19.3 (171)		2198-H070-ERSx
MPM-A1651F	3000	3000	5000	30.96	10.7 (94.7)	73.8	20.5 (181)	2.50	2198-H070-ERSx

Performance specification data and curves reflect nominal system performance of a typical system with motor at 40 °C (104 °F) and drive at 40 °C (104 °F) ambient and rated line voltage. For additional information on ambient and line conditions, refer to Motion Analyzer software.

Kinetix 5500 (200V-class operation) Drives/MP-Series Medium Inertia Motor Curves

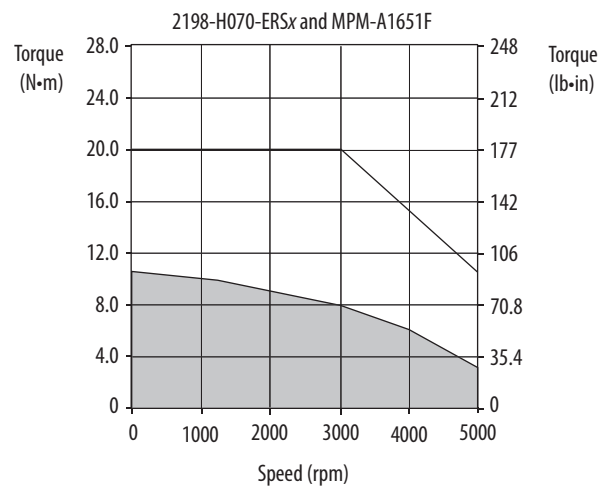
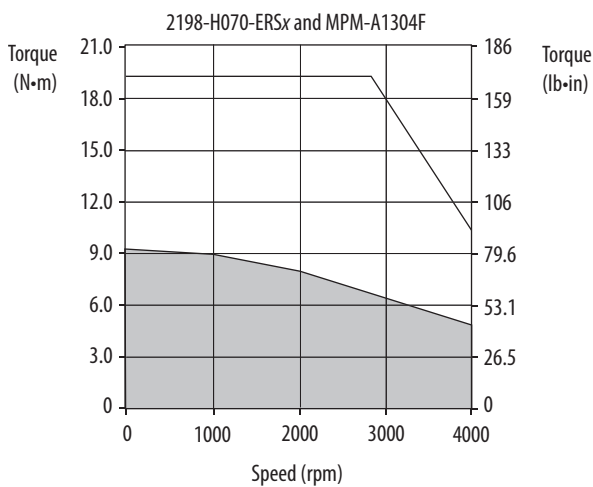
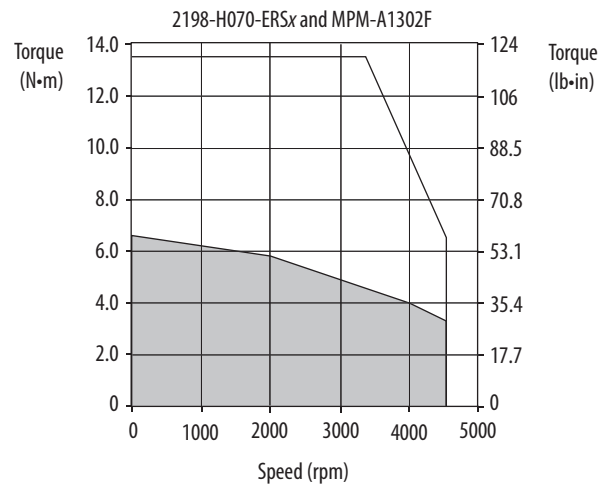
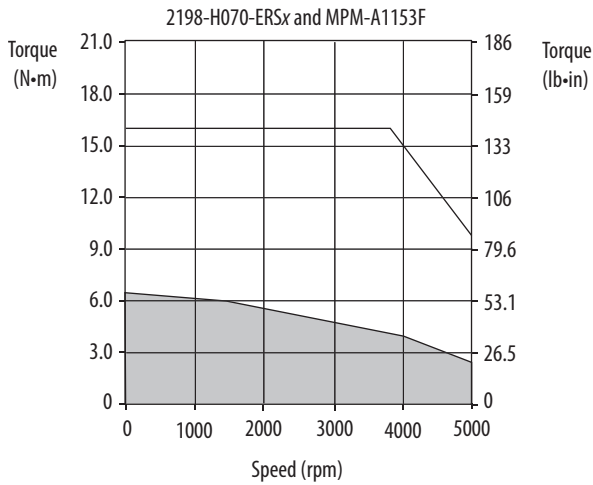
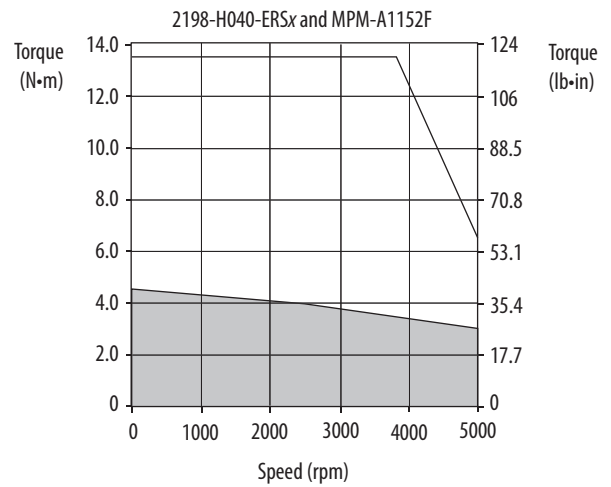
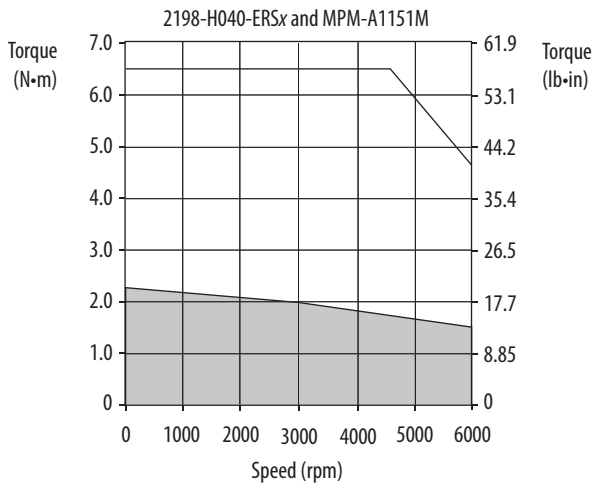

= Intermittent operating region
 = Continuous operating region

Kinetix 5500 (400V-class operation) Drives with MP-Series Medium Inertia Motors

This section provides system combination information for the Kinetix 5500 drives (with 400 and 480V, nominal input) when matched with MP-Series (400V-class) medium-inertia motors with absolute high-resolution encoders. Included are motor power/brake and feedback cable catalog numbers, system performance specifications, and the optimum torque/speed curves.

IMPORTANT These motors require the 2198-H2DCK (series B or later) feedback converter kit.

Bulletin MPM Motor Cable Combinations

Rotary Motor (400V-class) Cat. No.	Motor Power/Brake Cable	Motor Feedback Cable ⁽¹⁾
MPM-B1151x, MPM-B1152x, MPM-B1153E, MPM-B1153F	2090-CPxM7DF-16AAxx (standard, non-flex) 2090-CPxM7DF-16AFxx (continuous-flex)	2090-CFBM7DF-CEAAxx (standard, non-flex) ⁽²⁾ 2090-CFBM7DF-CEAFxx (continuous-flex) Absolute High-resolution Feedback
MPM-B1302F, MPM-B1302M, MPM-B1304C, MPM-B1304E		
MPM-B1651C, MPM-B1652C		
MPM-B1153T	2090-CPxM7DF-14AAxx (standard, non-flex) 2090-CPxM7DF-14AFxx (continuous-flex)	
MPM-B1302T, MPM-B1304M		
MPM-B1651F, MPM-B1653C	2090-CPxM7DF-10AAxx (standard, non-flex) 2090-CPxM7DF-10AFxx (continuous-flex)	
MPM-B1651M, MPM-B1652E, MPM-B1652F, MPM-B1653E		
MPM-B2152C, MPM-B2153B		

(1) Use the 2198-H2DCK (series B or later) Hipurface-to-DSL feedback converter kit with flying-lead cables on the drive end. Refer to Required Drive Accessories on [page 8](#).

(2) Applies to Kinetix 5500 drives and MPM-B1xxx-M/S through MPM-B2xxx-M/S motors with absolute high-resolution feedback.

For cable configuration illustrations and feature descriptions, by catalog number, refer to 2090-Series Motor Power/Brake and Feedback Cables Overview beginning on [page 14](#). Motor-end connector kits are available for motor power/brake and feedback cables. Refer to the Kinetix Motion Accessories Technical Data, publication [KNX-TD004](#), for more information. Cable length xx is in meters. Refer to the Kinetix Motion Accessories Technical Data, publication [KNX-TD004](#), for standard cable lengths.

Bulletin MPM Motor Performance Specifications with Kinetix 5500 (400V-class operation) Drives

Rotary Motor Cat. No.	Base Speed rpm	Rated Speed rpm	Speed, max rpm	System Continuous Stall Current A 0-pk	System Continuous Stall Torque N·m (lb·in)	System Peak Stall Current A 0-pk	System Peak Stall Torque N·m (lb·in)	Motor Rated Output kW	Kinetix 5500 Drives (480V AC input)
MPM-B1151F	3000	4000	5000	2.71	2.3 (20.3)	8.8	6.0 (53.1)	0.75	2198-H008-ERSx
						9.9	6.6 (58.0)		2198-H015-ERSx
MPM-B1151T	6000	5000	7000	5.62	2.3 (20.3)	17.7	5.3 (46.9)	0.90	2198-H015-ERSx
						20.5	5.9 (52.2)		2198-H025-ERSx
MPM-B1152C	1500	2500	3000	3.61	5.0 (44.2)	12.4	13.5 (119)	1.20	2198-H015-ERSx
MPM-B1152F	3000	4000	5200	6.17	5.0 (44.2)	17.7	11.7 (103)	1.40	2198-H015-ERSx
						21.1	13.5 (119)		2198-H025-ERSx
MPM-B1152T	6000	4000	7000	11.02	5.0 (44.2)	28.3	10.7 (94.7)	1.40	2198-H025-ERSx
						37.9	13.5 (119)		2198-H040-ERSx
MPM-B1153E	2250	3000	3500	6.21	6.5 (57.5)	17.7	16.9 (149)	1.40	2198-H015-ERSx
						21.6	19.8 (175)		2198-H025-ERSx
MPM-B1153F	3000	4000	5500	9.20	6.5 (57.5)	28.3	17.9 (158)	1.40	2198-H025-ERSx
						32.0	19.8 (175)		2198-H040-ERSx
MPM-B1153T	6000	4000	7000	15.95	6.5 (57.5)	45.9	14.8 (131)	1.45	2198-H040-ERSx
						55.5	16.5 (146)		2198-H070-ERSx
MPM-B1302F	3000	4000	4500	8.57	6.6 (58.4)	22.1	13.5 (119)	1.65	2198-H025-ERSx
MPM-B1302M	4500	4000	6000	12.57	6.6 (58.4)	32.4	13.5 (119)	1.65	2198-H040-ERSx
MPM-B1302T	6000	4000	7000	16.83	6.7 (59.3)	43.4	13.5 (119)	1.65	2198-H040-ERSx
MPM-B1304C	1500	1870	2750	7.00	10.3 (91.1)	17.7	22.8 (202)	2.00	2198-H015-ERSx
						21.5	27.1 (240)		2198-H025-ERSx
MPM-B1304E	2250	3500	4000	10.75	10.2 (90.3)	28.3	23.4 (207)	2.20	2198-H025-ERSx
						34.2	27.1 (240)		2198-H040-ERSx
MPM-B1304M	4500	3500	6000	19.02	10.4 (92.0)	60.6	27.1 (240)	2.20	2198-H070-ERSx
MPM-B1651C	1500	3000	3500	10.21	11.4 (101)	28.3	22.7 (201)	2.50	2198-H025-ERSx
						29.2	23.2 (205)		2198-H040-ERSx
MPM-B1651F	3000	3000	5000	17.75	11.4 (101)	45.9	21.9 (194)	2.50	2198-H040-ERSx
						50.9	23.2 (205)		2198-H070-ERSx
MPM-B1651M	4500	3000	5000	22.46	11.4 (101)	56.8	23.2 (205)	2.50	2198-H070-ERSx
MPM-B1652C	1500	2500	2500	11.51	16.0 (142)	33.6	40.0 (354)	3.80	2198-H040-ERSx
MPM-B1652E	2250	3500	3500	20.94	21.1 (187)	60.5	48.0 (425)	4.30	2198-H070-ERSx
MPM-B1652F	3000	3500	4500	28.74	21.1 (187)	84.1	48.0 (425)	4.30	2198-H070-ERSx
MPM-B1653C	1500	2000	2500	20.05	26.7 (236)	59.2	67.8 (600)	4.60	2198-H070-ERSx
MPM-B1653E	2250	3000	3500	27.00	26.8 (237)	72.9	62.0 (549)	5.10	2198-H070-ERSx
MPM-B2152C	1500	2000	2500	27.40	36.7 (325)	55.4	72.3 (640)	5.60	2198-H070-ERSx
MPM-B2153B	1250	1750	2000	24.06	48.0 (425)	60.0	101.1 (895)	6.80	2198-H070-ERSx

Performance specification data and curves reflect nominal system performance of a typical system with motor at 40 °C (104 °F) and drive at 40 °C (104 °F) ambient and rated line voltage. For additional information on ambient and line conditions, refer to Motion Analyzer software.

Kinetix 5500 (400V-class operation) Drives/MP-Series Medium Inertia Motor Curves

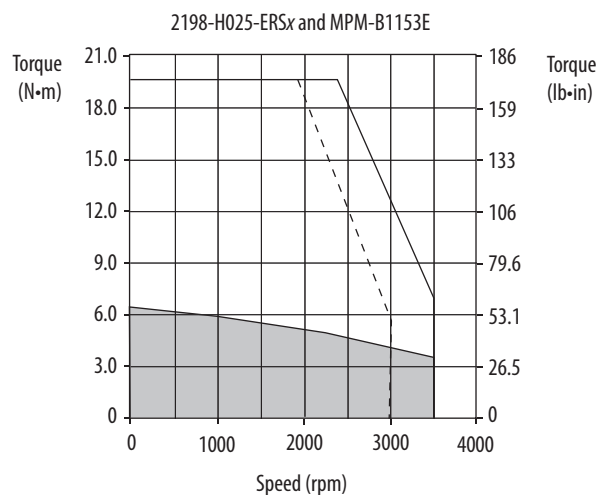
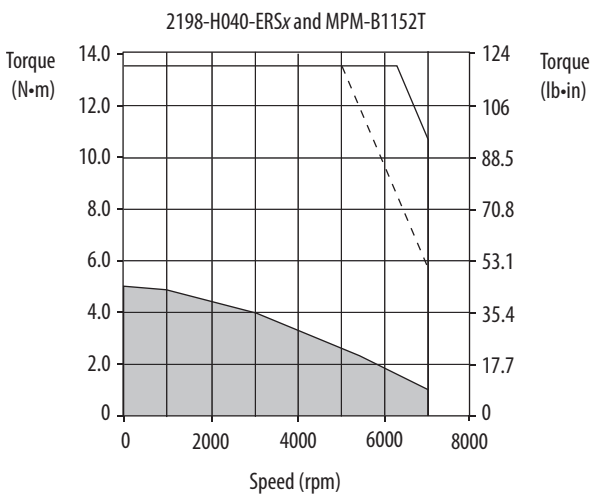
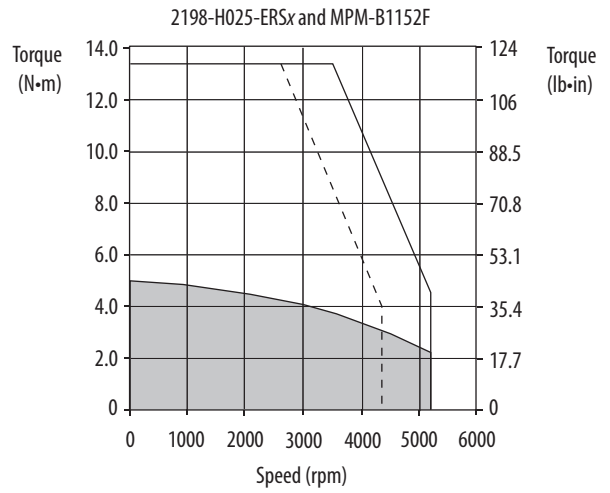
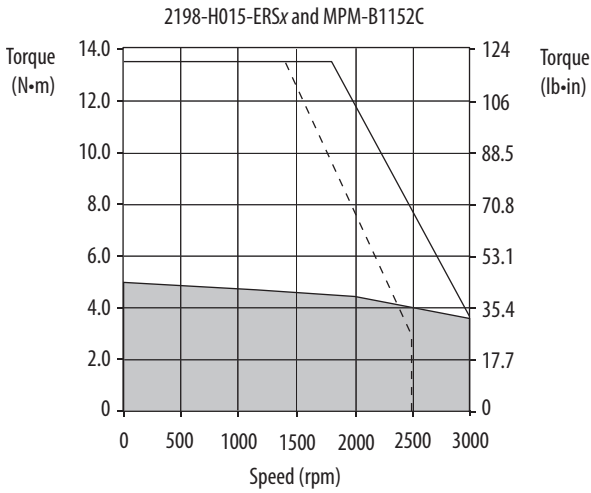
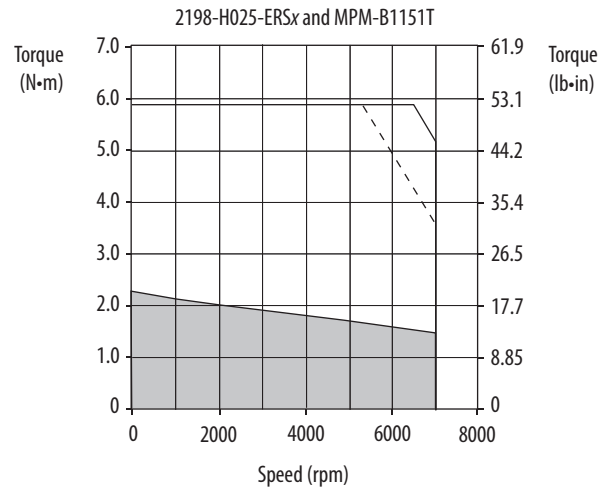
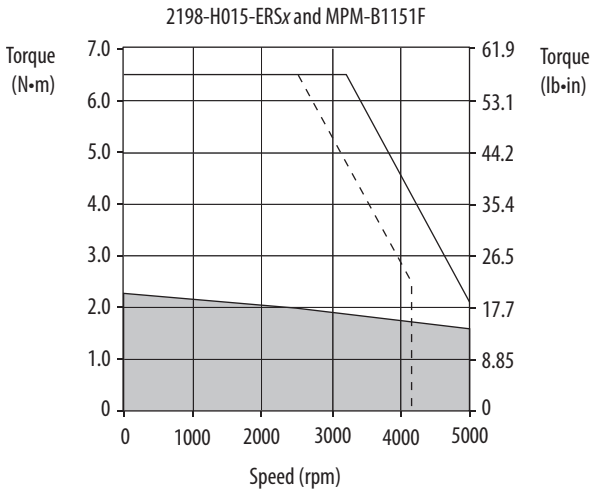

- = Intermittent operating region
- = Continuous operating region
- = Drive operation with 400V AC rms input voltage

Kinetix 5500 (400V-class operation) Drives/MP-Series Medium Inertia Motor Curves (continued)

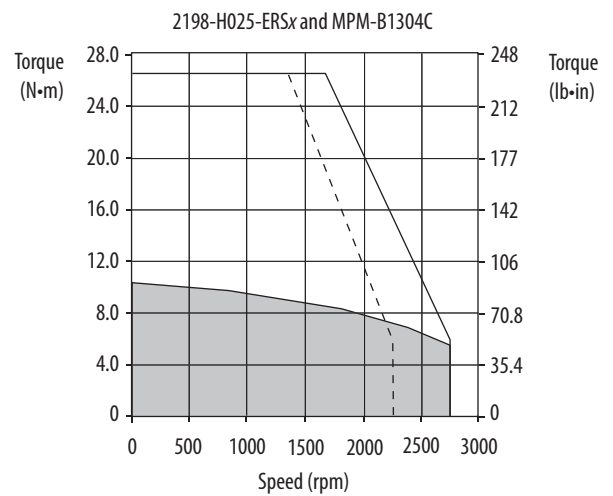
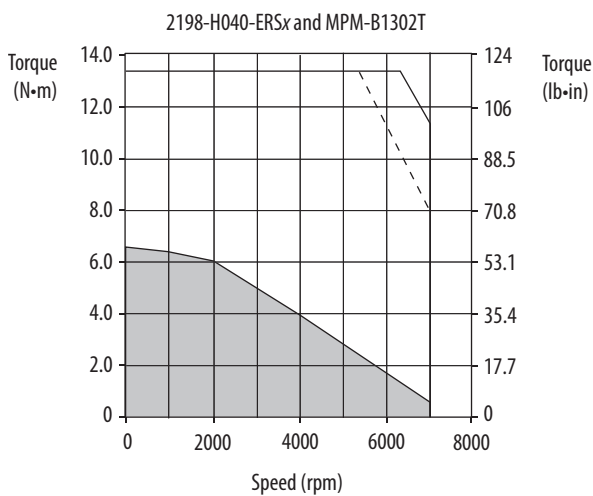
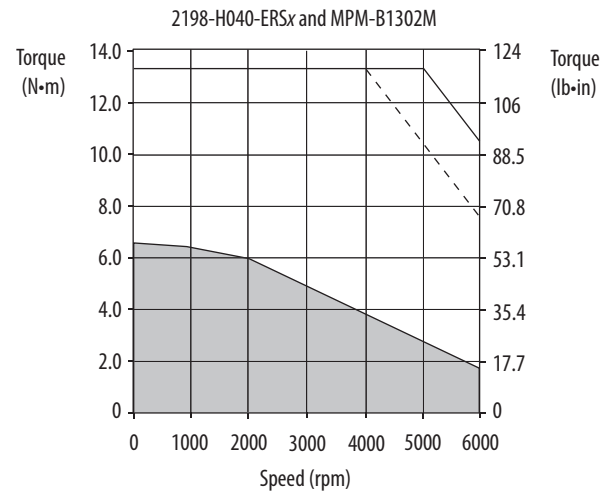
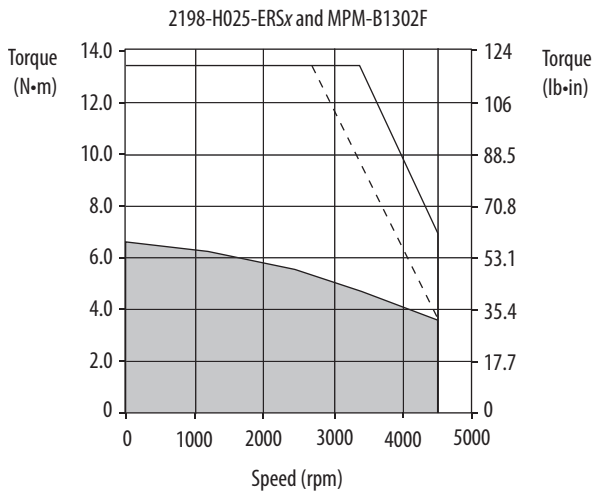
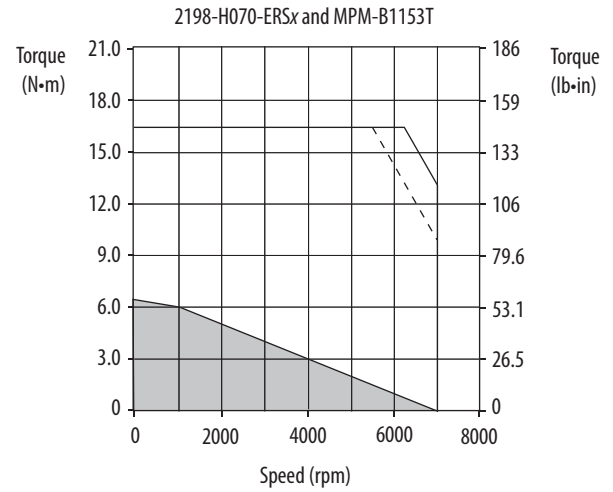
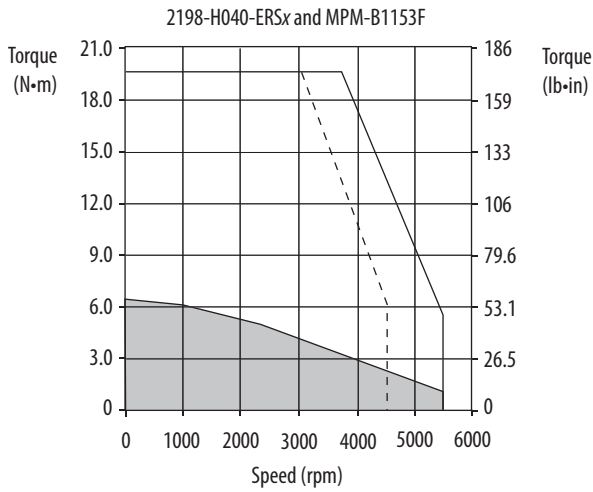

- = Intermittent operating region
- = Continuous operating region
- = Drive operation with 400V AC rms input voltage

Kinetix 5500 (400V-class operation) Drives/MP-Series Medium Inertia Motor Curves (continued)

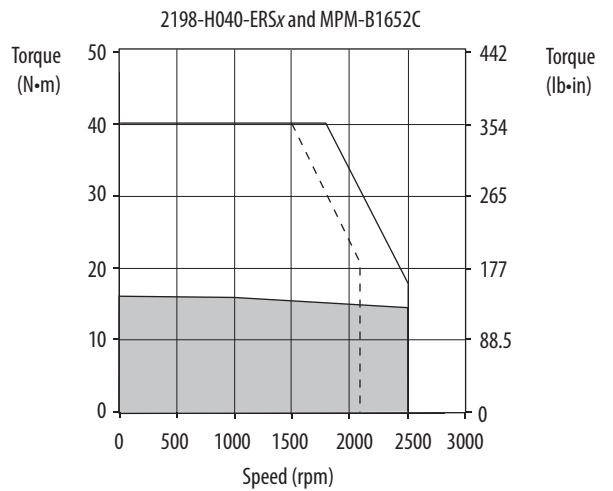
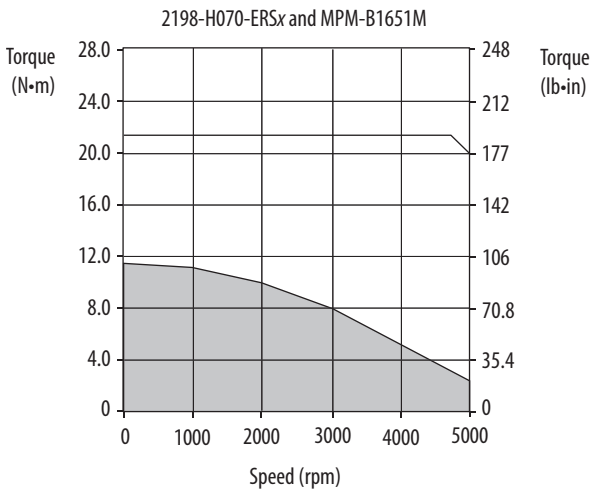
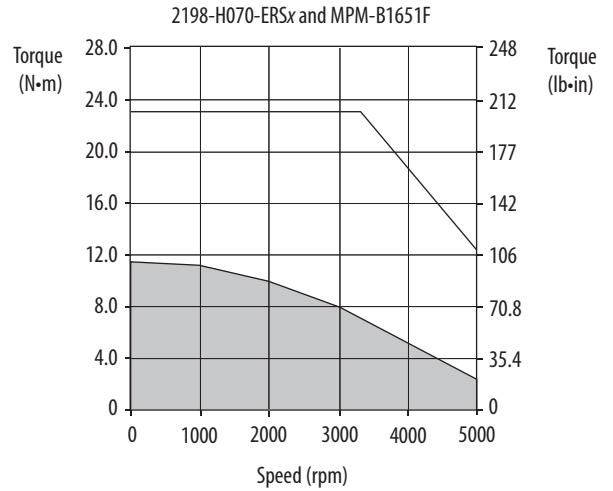
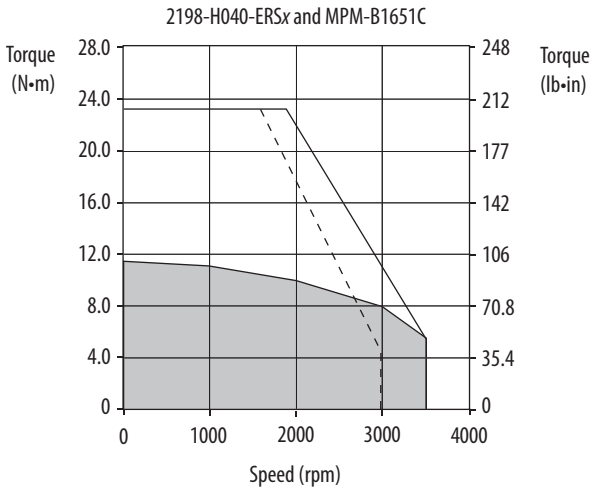
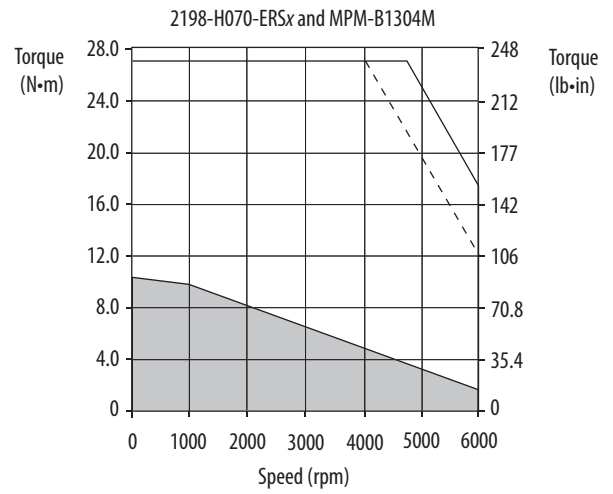
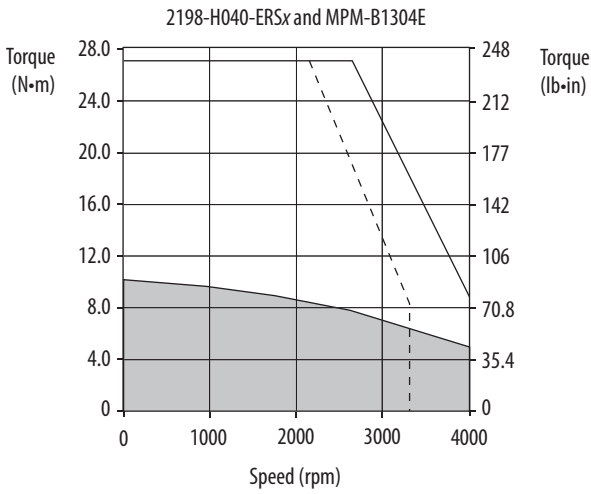

- = Intermittent operating region
- = Continuous operating region
- = Drive operation with 400V AC rms input voltage

Kinetix 5500 (400V-class operation) Drives/MP-Series Medium Inertia Motor Curves (continued)

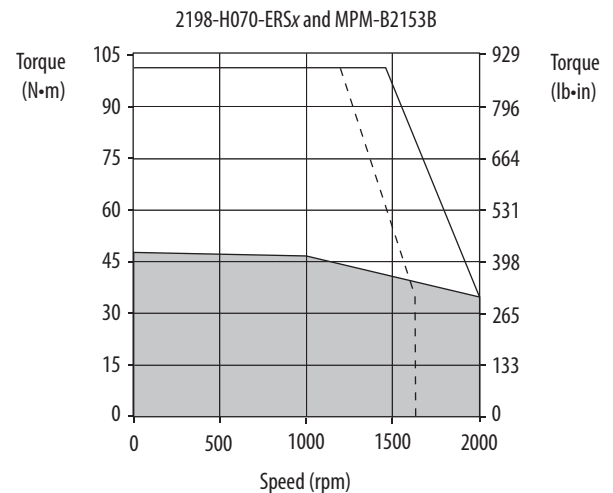
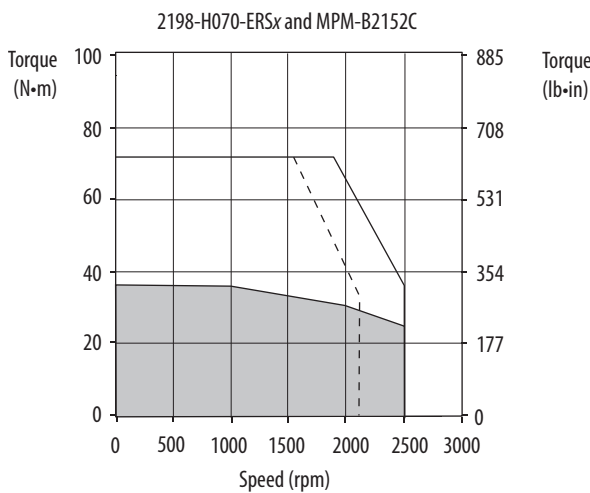
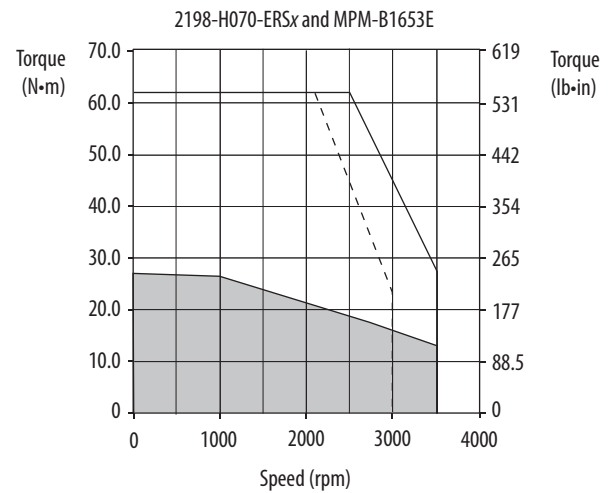
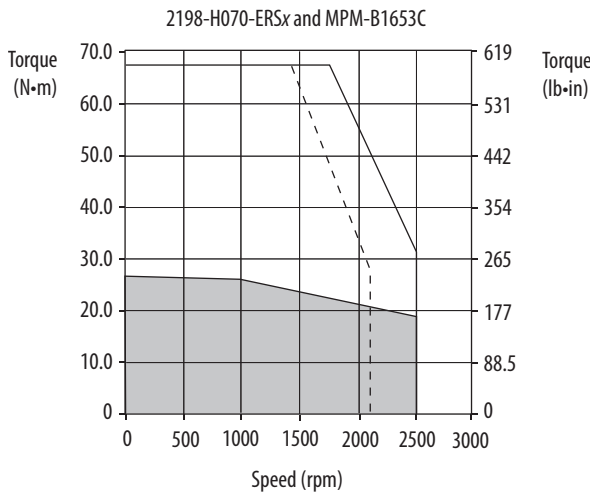
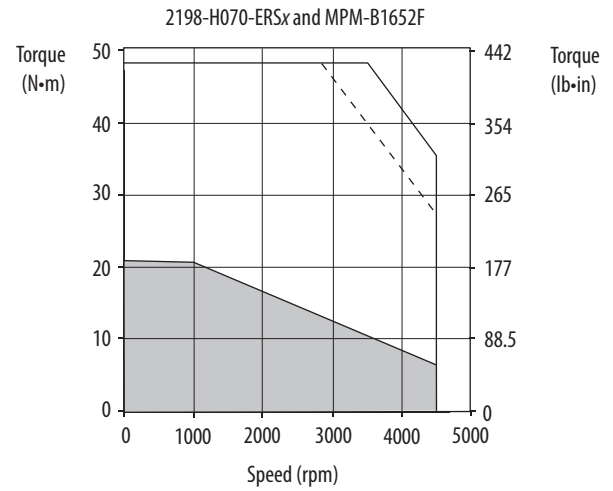
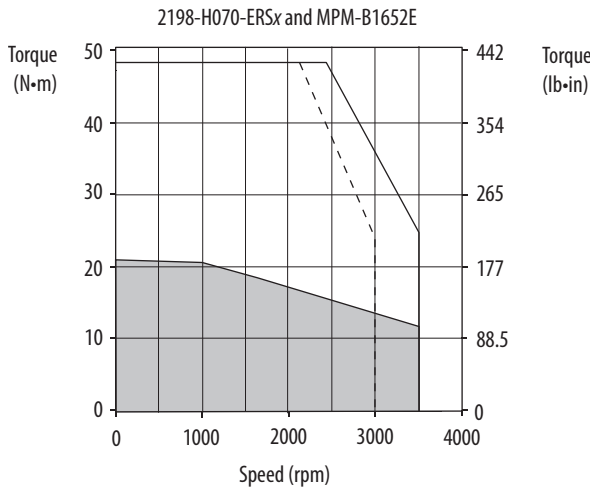

- = Intermittent operating region
- = Continuous operating region
- = Drive operation with 400V AC rms input voltage

Kinetix 5500 (200V-class operation) Drives with MP-Series Food Grade Motors

This section provides system combination information for the Kinetix 5500 drives (with 240V, nominal input) when matched with MP-Series (200V-class) food-grade motors. Included are motor power/brake and feedback cable catalog numbers, system performance specifications, and the optimum torque/speed curves.

IMPORTANT These motors require the 2198-H2DCK (series B or later) feedback converter kit.

Kinetix 5500 servo drives are capable of 200V or 400V-class operation. These system performance tables and torque/speed curves reflect single-phase and three-phase drive operation with 200V-class motors; however, only 2198-H003-ERSx, 2198-H008-ERSx, and 2198-H015-ERSx drives are capable of single-phase operation.

Bulletin MPF Motor Cable Combinations

Rotary Motor (200V-class) Cat. No.	Motor Power/Brake Cable	Motor Feedback Cable ⁽¹⁾
MPF-A310P, MPF-A320H, MPF-A320P, MPF-A330P	2090-CPxM7DF-16AAxx (standard, non-flex) 2090-CPxM7DF-16AFxx (continuous-flex)	2090-CFBM7DF-CEAAxx (standard, non-flex) 2090-CFBM7DF-CEAFxx (continuous-flex) Absolute High-resolution Feedback
MPF-A430H		
MPF-A430P MPF-A4540F, MPF-A4530K	2090-CPxM7DF-14AAxx (standard, non-flex) 2090-CPxM7DF-14AFxx (continuous-flex)	
MPF-A540K	2090-CPxM7DF-08AAxx (standard, non-flex) 2090-CPxM7DF-08AFxx (continuous-flex)	

(1) Use the 2198-H2DCK (series B or later) Hiperface-to-DSL feedback converter kit with flying-lead cables on the drive end. Refer to Required Drive Accessories on [page 8](#).

For cable configuration illustrations and feature descriptions, by catalog number, refer to 2090-Series Motor Power/Brake and Feedback Cables Overview beginning on [page 14](#). Motor-end connector kits are available for motor power/brake and feedback cables. Refer to the Kinetix Motion Accessories Technical Data, publication [KNX-TD004](#), for more information. Cable length xx is in meters. Refer to the Kinetix Motion Accessories Technical Data, publication [KNX-TD004](#), for standard cable lengths.

Bulletin MPF Motor Performance Specifications with Kinetix 5500 (200V-class) Drives

Rotary Motor Cat. No.	Rated Speed rpm	Speed, max rpm	System Continuous Stall Current A 0-pk	System Continuous Stall Torque N·m (lb·in)	System Peak Stall Current A 0-pk	System Peak Stall Torque N·m (lb·in)	Motor Rated Output kW	Kinetix 5500 Drives (240V AC input)
MPF-A310P	4750	5000	4.50	1.58 (14.0)	14.0	3.61 (31.9)	0.73	2198-H015-ERSx
MPF-A320H	3350	3500	6.10	3.05 (27.0)	17.7	7.33 (64.9)	1.0	2198-H015-ERSx
					19.3	7.91 (70.0)		2198-H025-ERSx
MPF-A320P	4750	5000	9.00	3.05 (27.0)	28.3	7.59 (67.2)	1.3	2198-H025-ERSx
					29.5	7.91 (70.0)		2198-H040-ERSx
MPF-A330P	5000	5000	12.0	3.85 (34.0)	38.0	10.32 (91.2)	1.6	2198-H040-ERSx
MPF-A430H	3500	3500	12.2	6.21 (55.0)	45.0	19.82 (175)	1.8	2198-H040-ERSx
MPF-A430P	5000	5000	16.80	5.94 (52.5)	45.9	14.4 (127)	1.9	2198-H040-ERSx
					67.0	19.80 (175)		2198-H070-ERSx
MPF-A4530K	4000	4000	19.50	8.08 (71.4)	62.0	20.30 (179)	2.3	2198-H070-ERSx
MPF-A4540F	3000	3000	18.40	10.15 (89.7)	45.9	22.09 (195)	2.5	2198-H040-ERSx
					58.0	27.10 (239)		2198-H070-ERSx

Performance specification data and curves reflect nominal system performance of a typical system with motor at 40 °C (104 °F) and drive at 40 °C (104 °F) ambient and rated line voltage. For additional information on ambient and line conditions, refer to Motion Analyzer software.

Kinetix 5500 (200V-class operation) Drives/MP-Series Food Grade Motor Curves

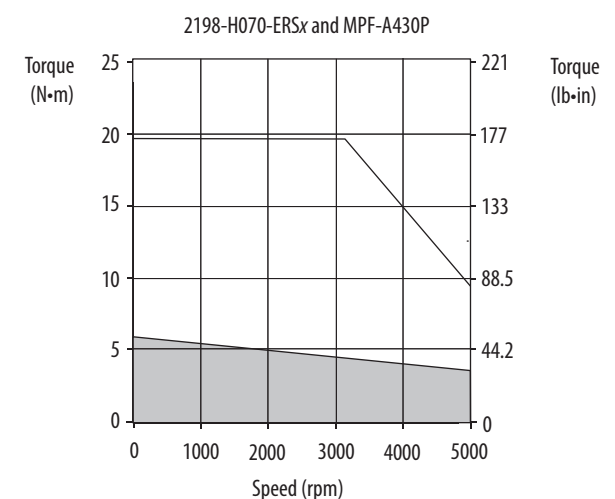
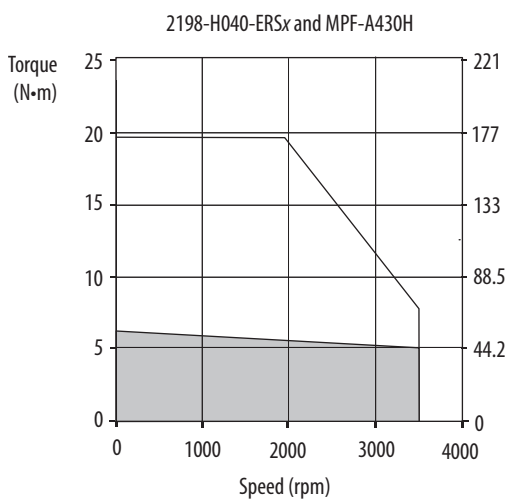
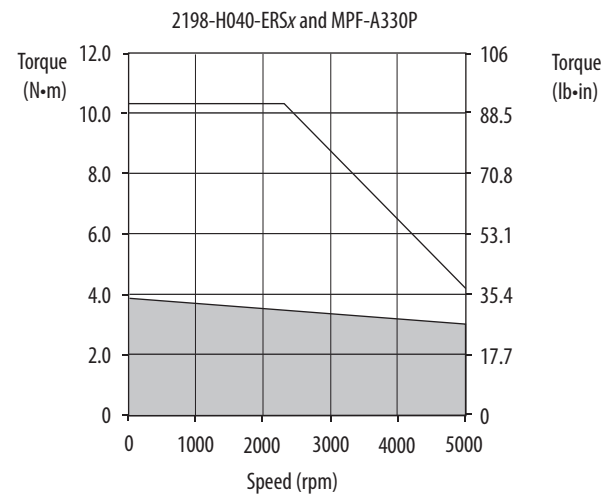
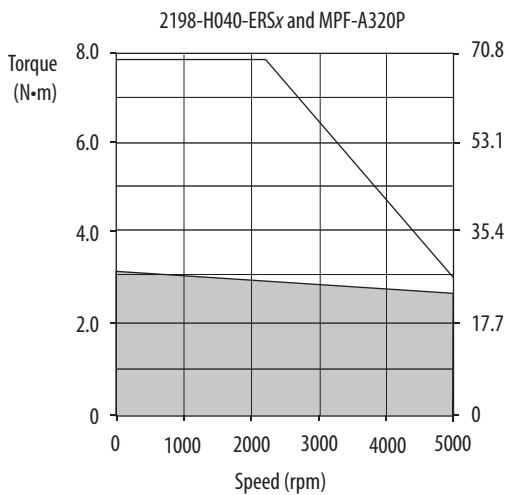
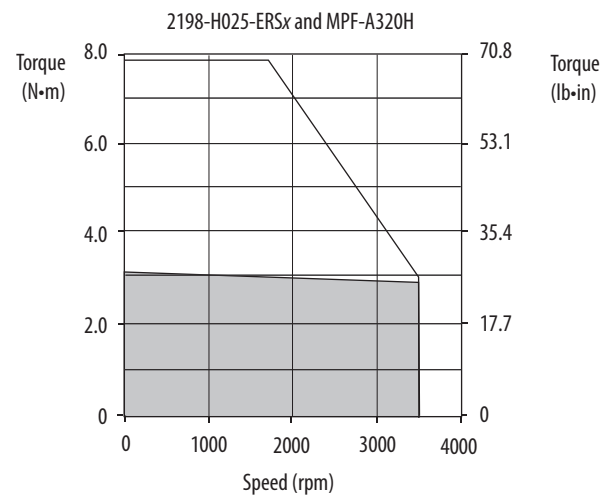
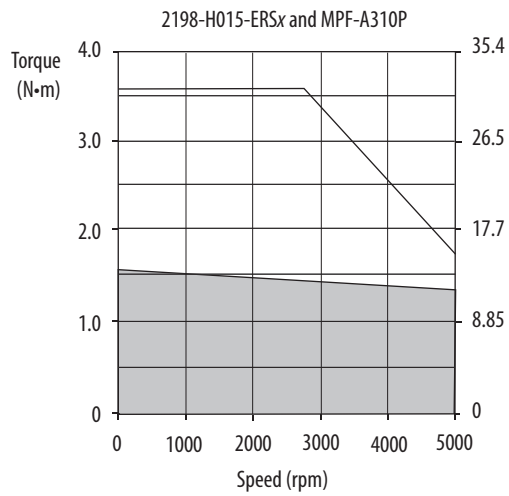

= Intermittent operating region
 = Continuous operating region

Kinetix 5500 (200V-class operation) Drives/MP-Series Food Grade Motor Curves (continued)

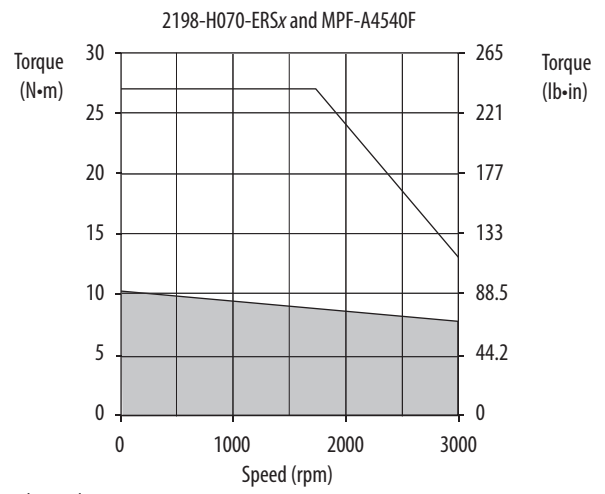
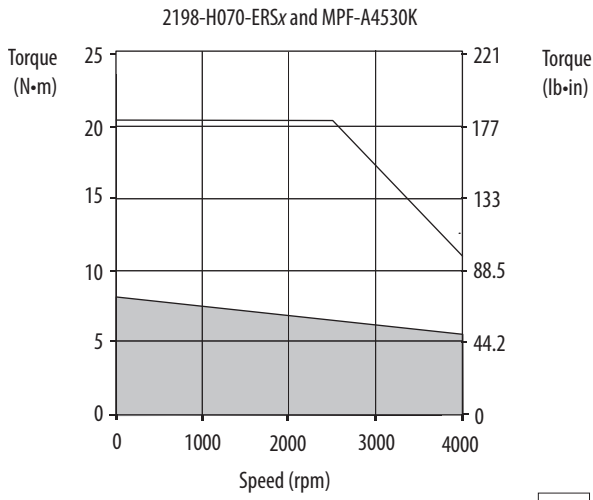

= Intermittent operating region
 = Continuous operating region

Kinetix 5500 (400V-class operation) Drives with MP-Series Food Grade Motors

This section provides system combination information for the Kinetix 5500 drives (with 400 and 480V, nominal input) when matched with MP-Series (400V-class) food-grade motors. Included are motor power/brake and feedback cable catalog numbers, system performance specifications, and the optimum torque/speed curves.

IMPORTANT These motors require the 2198-H2DCK (series B or later) feedback converter kit.

Bulletin MPF Motor Cable Combinations

Rotary Motor (400V-class) Cat. No.	Motor Power/Brake Cable	Motor Feedback Cable ⁽¹⁾
MPF-B310P, MPF-B320P, MPF-B330P	2090-CPxM7DF-16AAxx (standard, non-flex) 2090-CPxM7DF-16AFxx (continuous-flex)	2090-CFBM7DF-CEAAxx (standard, non-flex) 2090-CFBM7DF-CEAFxx (continuous-flex) Absolute High-resolution Feedback
MPF-B430P		
MPF-B4530K, MPF-B4540F		
MPF-B540K	2090-CPxM7DF-10AAxx (standard, non-flex) 2090-CPxM7DF-10AFxx (continuous-flex)	

(1) Use the 2198-H2DCK (series B or later) Hipurface-to-DSL feedback converter kit with flying-lead cables on the drive end. Refer to Required Drive Accessories on [page 8](#).

For cable configuration illustrations and feature descriptions, by catalog number, refer to 2090-Series Motor Power/Brake and Feedback Cables Overview beginning on [page 14](#). Motor-end connector kits are available for motor power/brake and feedback cables. Refer to the Kinetix Motion Accessories Technical Data, publication [KNX-TD004](#), for more information. Cable length xx is in meters. Refer to the Kinetix Motion Accessories Technical Data, publication [KNX-TD004](#), for standard cable lengths.

Bulletin MPF Motor Performance Specifications with Kinetix 5500 (400V-class operation) Drives

Rotary Motor Cat. No.	Rated Speed rpm	Speed, max rpm	System Continuous Stall Current A 0-pk	System Continuous Stall Torque N·m (lb·in)	System Peak Stall Current A 0-pk	System Peak Stall Torque N·m (lb·in)	Motor Rated Output kW	Kinetix 5500 Drives (480V AC operation)
MPF-B310P	5000	5000	2.30	1.60 (14)	7.10	3.6 (32)	0.77	2198-H008-ERSx
MPF-B320P	5000	5000	4.24	3.10 (27)	14.0	7.8 (69)	1.5	2198-H015-ERSx
MPF-B330P	5000	5000	5.70	4.18 (37)	17.7	10.4 (92.0)	1.6	2198-H015-ERSx
					19.0	11.1 (98)		2198-H025-ERSx
MPF-B430P	5000	5000	9.20	6.55 (58)	28.3	17.6 (156)	2.0	2198-H025-ERSx
					32.0	19.8 (175)		2198-H040-ERSx
MPF-B4530K	4000	4000	9.90	8.25 (73)	28.3	18.7 (165)	2.4	2198-H025-ERSx
					31.0	20.3 (179)		2198-H040-ERSx
MPF-B4540F	3000	3000	9.10	10.20 (90)	28.3	26.2 (232)	2.5	2198-H025-ERSx
					29.0	27.1 (240)		2198-H040-ERSx
MPF-B540K	4000	4000	20.5	19.4 (171)	60.0	48.6 (430)	4.1	2198-H070-ERSx

Performance specification data and curves reflect nominal system performance of a typical system with motor at 40 °C (104 °F) and drive at 40 °C (104 °F) ambient and rated line voltage. For additional information on ambient and line conditions, refer to Motion Analyzer software.

Kinetix 5500 (400V-class operation) Drives/MP-Series Food Grade Motor Curves

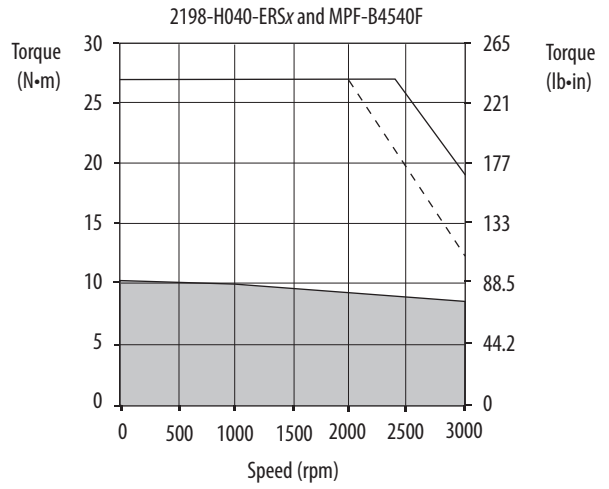
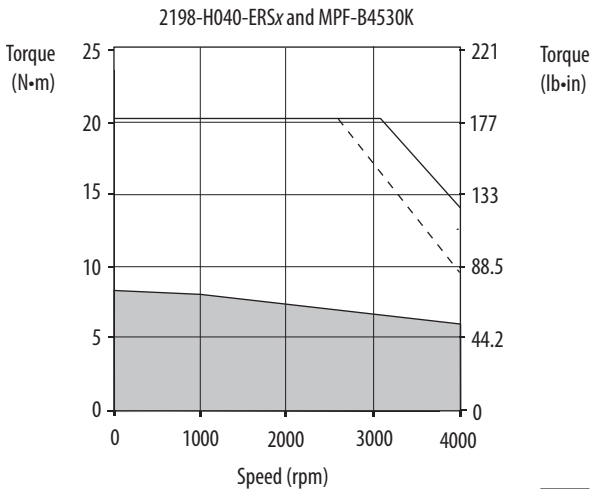
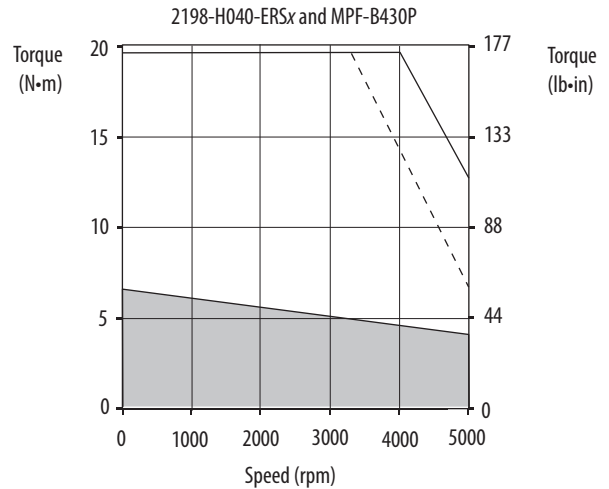
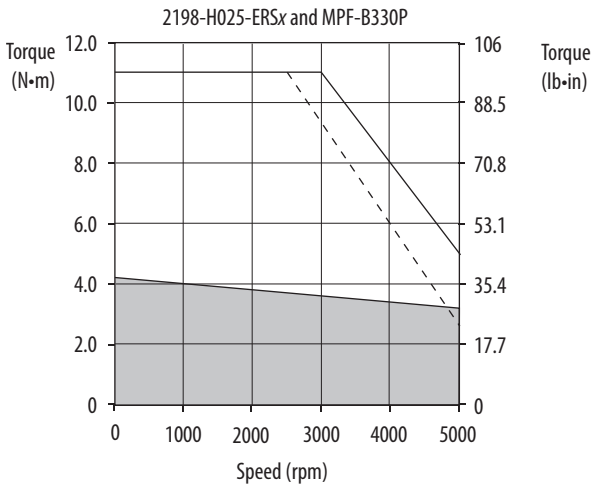
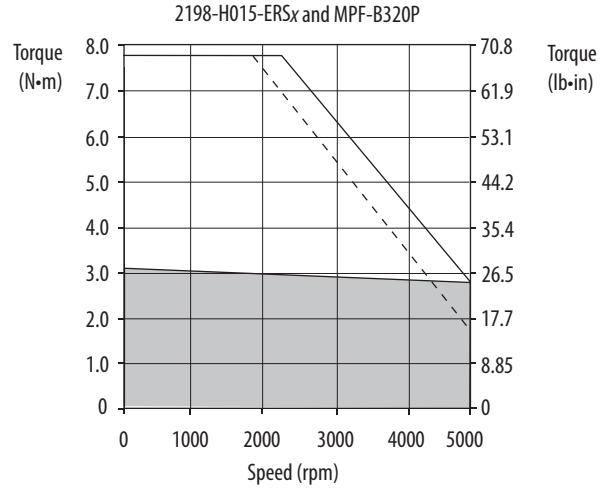
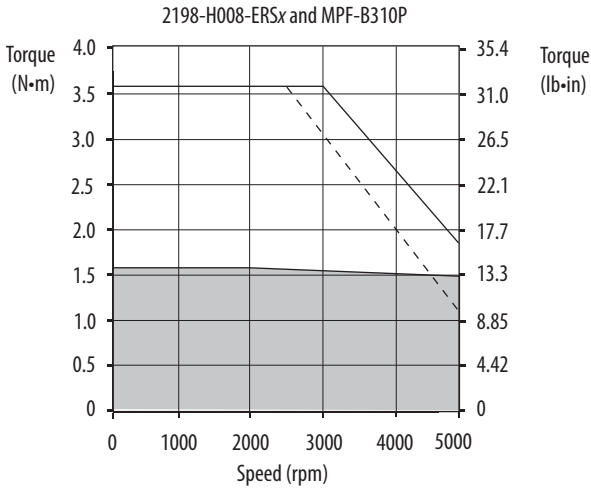

= Intermittent operating region
 = Continuous operating region
 = Drive operation with 400V AC rms input voltage

Kinetix 5500 (400V-class operation) Drives/MP-Series Food Grade Motor Curves (continued)

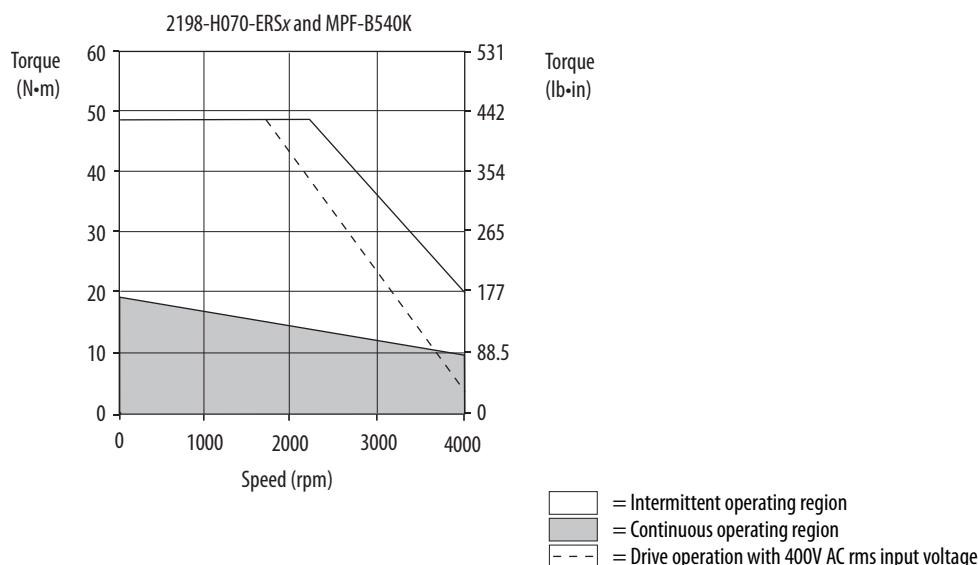

Kinetix 5500 (200V-class operation) Drives with MP-Series Stainless Steel Motors

This section provides system combination information for the Kinetix 5500 drives (with 240V, nominal input) when matched with MP-Series (200V-class) stainless-steel motors. Included are motor power/brake and feedback cable catalog numbers, system performance specifications, and the optimum torque/speed curves.

IMPORTANT These motors require the 2198-H2DCK (series B or later) feedback converter kit.

Kinetix 5500 servo drives are capable of 200V or 400V-class operation. These system performance tables and torque/speed curves reflect single-phase and three-phase drive operation with 200V-class motors; however, only 2198-H003-ERSx, 2198-H008-ERSx, and 2198-H015-ERSx drives are capable of single-phase operation.

Bulletin MPS Motor Cable Combinations

Rotary Motor (200V-class) Cat. No.	Motor Power/Brake Cable	Motor Feedback Cable ⁽¹⁾
MPS-A330P	2090-CPxM7DF-16AAxx (standard, non-flex) 2090-CPxM7DF-16AFxx (continuous-flex)	2090-CFBM7DF-CEAAxx (standard, non-flex) 2090-CFBM7DF-CEAFxx (continuous-flex) Absolute High-resolution Feedback
MPS-A4540F		

(1) Use the 2198-H2DCK (series B or later) Hiperface-to-DSL feedback converter kit with flying-lead cables on the drive end. Refer to Required Drive Accessories on [page 8](#).

For cable configuration illustrations and feature descriptions, by catalog number, refer to 2090-Series Motor Power/Brake and Feedback Cables Overview beginning on [page 14](#). Motor-end connector kits are available for motor power/brake and feedback cables. Refer to the Kinetix Motion Accessories Technical Data, publication [KNX-TD004](#), for more information. Cable length xx is in meters. Refer to the Kinetix Motion Accessories Technical Data, publication [KNX-TD004](#), for standard cable lengths.

Bulletin MPS Motor Performance Specifications with Kinetix 5500 (200V-class operation) Drives

Rotary Motor Cat. No.	Rated Speed rpm	Speed, max rpm	System Continuous Stall Current A 0-pk	System Continuous Stall Torque N·m (lb·in)	System Peak Stall Current A 0-pk	System Peak Stall Torque N·m (lb·in)	Motor Rated Output kW	Kinetix 5500 Drives (240V AC operation)
MPS-A330P	5000	5000	9.80	3.60 (32.0)	28.3	8.79 (77.8)	1.3	2198-H025-ERSx
					38.0	11.10 (98.2)		2198-H040-ERSx
MPS-A4540F	3000	3000	14.4	8.1 (72)	45.9	22.84 (202)	1.4	2198-H040-ERSx
					56.0	27.1 (240)		2198-H070-ERSx

Performance specification data and curves reflect nominal system performance of a typical system with motor at 40 °C (104 °F) and drive at 40 °C (104 °F) ambient and rated line voltage. For additional information on ambient and line conditions, refer to Motion Analyzer software.

Kinetix 5500 (200V-class operation) Drives/MP-Series Stainless Steel Motor Curves

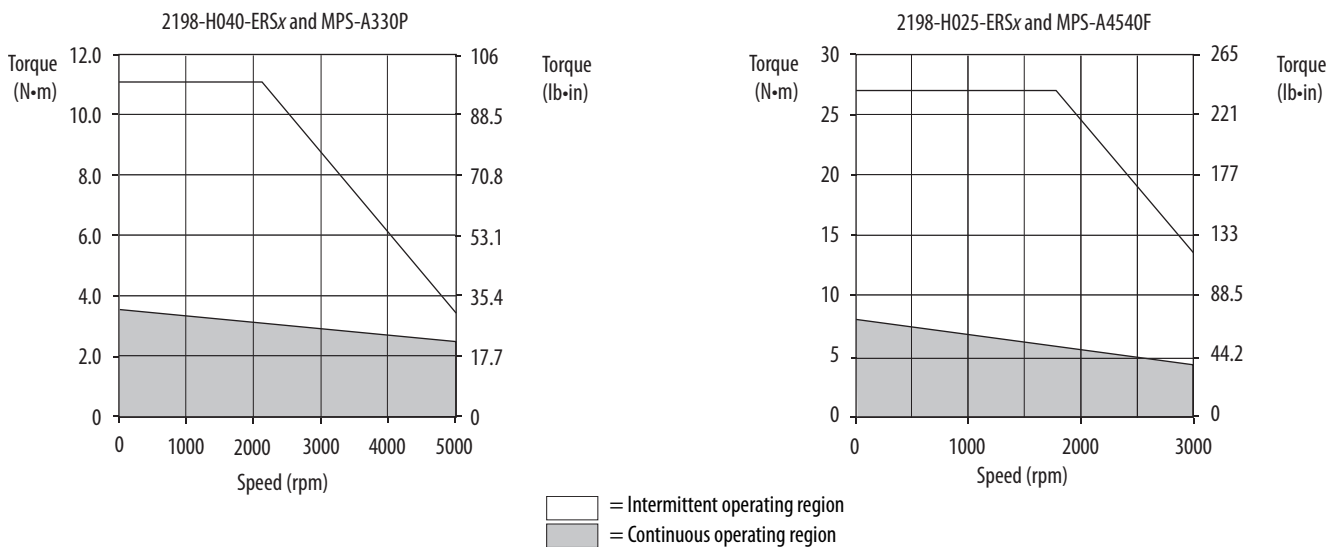

Kinetix 5500 (400V-class operation) Drives with MP-Series Stainless Steel Motors

This section provides system combination information for the Kinetix 5500 drives (with 400 and 480V, nominal input) when matched with MP-Series (400V-class) stainless-steel motors. Included are motor power/brake and feedback cable catalog numbers, system performance specifications, and the optimum torque/speed curves.

IMPORTANT These motors require the 2198-H2DCK (series B or later) feedback converter kit.

Bulletin MPS Motor Cable Combinations

Rotary Motor (400V-class) Cat. No.	Motor Power Cable	Motor Feedback Cable ⁽¹⁾
MPS-B330P	2090-CPxM7DF-16AAxx (standard, non-flex) 2090-CPxM7DF-16AFxx (continuous-flex)	2090-CFBM7DF-CEAAxx (standard, non-flex) 2090-CFBM7DF-CEAFxx (continuous-flex) Absolute High-resolution Feedback
MPS-B4540F		
MPS-B560F	2090-CPxM7DF-14AAxx (standard, non-flex) 2090-CPxM7DF-14AFxx (continuous-flex)	

(1) Use the 2198-H2DCK (series B or later) Hipurface-to-DSL feedback converter kit with flying-lead cables on the drive end. Refer to Required Drive Accessories on [page 8](#).

For cable configuration illustrations and feature descriptions, by catalog number, refer to 2090-Series Motor Power/Brake and Feedback Cables Overview beginning on [page 14](#). Motor-end connector kits are available for motor power/brake and feedback cables. Refer to the Kinetix Motion Accessories Technical Data, publication [KNX-TD004](#), for more information. Cable length xx is in meters. Refer to the Kinetix Motion Accessories Technical Data, publication [KNX-TD004](#), for standard cable lengths.

Bulletin MPS Motor Performance Specifications with Kinetix 5500 (400V-class operation) Drives

Rotary Motor Cat. No.	Rated Speed rpm	Speed, max rpm	System Continuous Stall Current A 0-pk	System Continuous Stall Torque N·m (lb·in)	System Peak Stall Current A 0-pk	System Peak Stall Torque N·m (lb·in)	Motor Rated Output kW	Kinetix 5500 Drives (480V AC input)
MPS-B330P	5000	5000	4.9	3.60 (32)	17.7	10.5 (92.9)	1.3	2198-H015-ERSx
					19.0	11.0 (97.2)		2198-H025-ERSx
MPS-B4540F	3000	3000	7.1	8.1 (72)	17.7	19.2 (170)	1.4	2198-H015-ERSx
					26.0	27.1 (240)		2198-H025-ERSx
MPS-B560F	3000	3000	17.0	21.5 (190)	45.9	49.7 (440)	3.5	2198-H040-ERSx
					68.0	67.8 (600)		2198-H070-ERSx

Performance specification data and curves reflect nominal system performance of a typical system with motor at 40 °C (104 °F) and drive at 40 °C (104 °F) ambient and rated line voltage. For additional information on ambient and line conditions, refer to Motion Analyzer software.

Kinetix 5500 (400V-class operation) Drives/MP-Series Stainless Steel Motor Curves

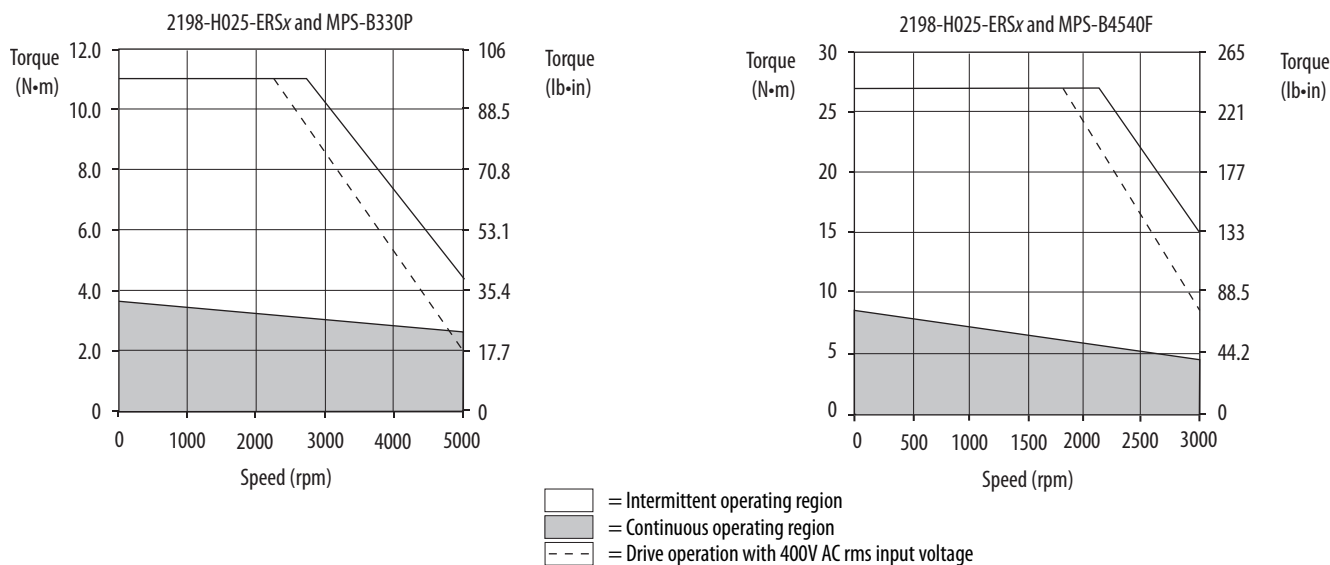

Kinetix 5500 (400V-class operation) Drives/MP-Series Stainless Steel Motor Curves (continued)

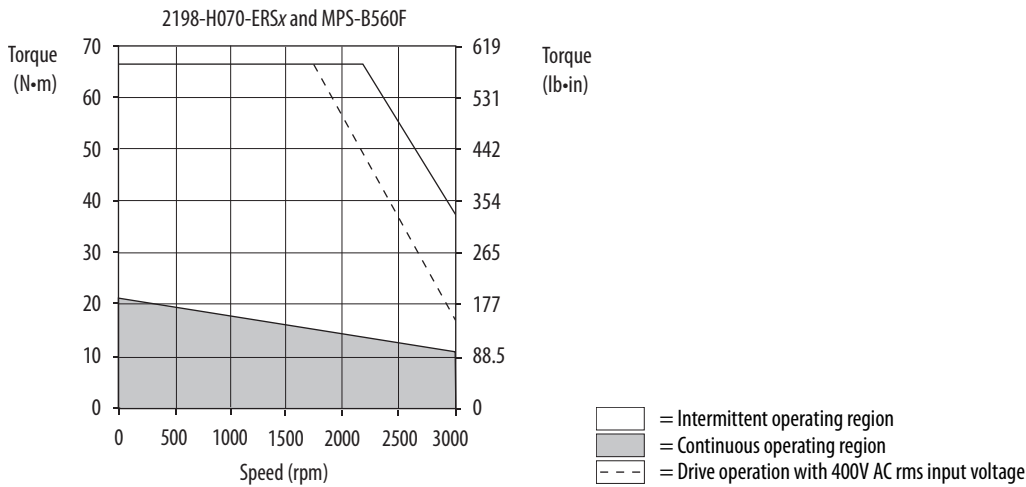

Kinetix 5500 Servo Drives with LDAT-Series Integrated Linear Thrusters

This section provides system combination information for the Kinetix 5500 drives (with 240V and 480V, nominal input) when matched with LDAT-Series integrated linear thrusters. Included are motor power/brake and feedback cable catalog numbers, system performance specifications, and the optimum force/velocity curves.

IMPORTANT The LDAT-Series linear thrusters require the 2198-H2DCK (series B or later) feedback converter kit.

Kinetix 5500 servo drives are capable of 200V or 400V-class operation. The 200V-class system performance tables and force/velocity curves reflect single-phase and three-phase drive operation with 240V AC input; however, only 2198-H003-ERSx, 2198-H008-ERSx, and 2198-H015-ERSx drives are capable of single-phase operation.

LDAT-Series Cable Combinations

Linear Thruster Cat. No.	Motor Power Cable	Motor Feedback Cable ⁽¹⁾
LDAT-S031xxx-xDx, LDAT-S032xxx-xDx, LDAT-S033xxx-xDx	2090-CPWM7DF-16AAxx (standard, non-flex) 2090-CPWM7DF-16AFxx (continuous-flex)	2090-CFBM7DF-CEAAxx (standard, non-flex) ⁽²⁾ 2090-CFBM7DF-CEAFxx (continuous-flex) Absolute High-resolution Feedback
LDAT-S051xxx-xDx, LDAT-S052xxx-xDx, LDAT-S053xxx-xDx, LDAT-S054xxx-xDx		
LDAT-S072xxx-xDx, LDAT-S073xxx-xDx, LDAT-S074xxx-xDx, LDAT-S076xxx-EDx		
LDAT-S102xxx-xDx, LDAT-S103xxx-xDx, LDAT-S104xxx-xDx, LDAT-S106xxx-EDx		
LDAT-S152xxx-xDx, LDAT-S153xxx-xDx, LDAT-S154xxx-xDx, LDAT-S156xxx-EDx		
LDAT-S076xxx-DDx	2090-CPWM7DF-14AAxx (standard, non-flex) 2090-CPWM7DF-14AFxx (continuous-flex)	
LDAT-S106xxx-DDx		
LDAT-S156xxx-DDx		

(1) Use the 2198-H2DCK (series B or later) Hiurface-to-DSL feedback converter kit with flying-lead cables on the drive end. Refer to Required Drive Accessories on [page 8](#).

(2) Applies to Kinetix 5500 drives and LDAT-Sxxxxx-xDx linear thrusters with absolute high-resolution feedback.

For cable configuration illustrations and feature descriptions, by catalog number, refer to 2090-Series Motor Power/Brake and Feedback Cables Overview beginning on [page 14](#). Motor-end connector kits are available for motor power/brake and feedback cables. Refer to the Kinetix Motion Accessories Technical Data, publication [KNX-TD004](#), for more information. Cable length xx is in meters. Refer to the Kinetix Motion Accessories Technical Data, publication [KNX-TD004](#), for standard cable lengths.

LDAT-Series Performance Specifications with Kinetix 5500 (200V-class operation) Drives

Performance Specifications with Frame 30 Linear Thrusters

Linear Thruster Cat. No.	Velocity, max 230V AC m/s	System Continuous Stall Current Amps 0-pk	System Continuous Stall Force N (lb)	System Peak Stall Current Amps 0-pk	System Peak Stall Force N (lb)	Rated Output 230V AC kW	Kinetix 5500 Drives (240V AC input)
LDAT-S031010-DDx	2.4	4.8	81 (18)	12.2	168 (38)	0.20	2198-H015-ERSx
LDAT-S031020-DDx	3.1					0.25	
LDAT-S031030-DDx	3.5					0.29	
LDAT-S031040-DDx	3.8					0.31	
LDAT-S032010-DDx	3.1	7.4	126 (28)	24.3	336 (76)	0.44	2198-H025-ERSx
LDAT-S032020-DDx	4.1					0.52	
LDAT-S032030-DDx	4.7					0.59	
LDAT-S032040-DDx	5.0					0.63	
LDAT-S032010-EDx	3.1	3.7	126 (28)	12.2	336 (76)	0.40	2198-H015-ERSx
LDAT-S032020-EDx	4.1					0.47	
LDAT-S032030-EDx	4.7					0.52	
LDAT-S032040-EDx	5.0					0.55	
LDAT-S033010-DDx	3.5	11.1	190 (43)	36.5	504 (113)	0.67	2198-H040-ERSx
LDAT-S033020-DDx	4.7					0.88	
LDAT-S033030-DDx	5.0					0.95	
LDAT-S033040-DDx						0.95	
LDAT-S033010-EDx	3.5	3.7	190 (43)	12.2	504 (113)	0.55	2198-H015-ERSx
LDAT-S033020-EDx	4.4					0.65	
LDAT-S033030-EDx						0.65	
LDAT-S033040-EDx						0.65	

Performance specification data and curves reflect nominal system performance of a typical system with motor at 40 °C (104 °F) and drive at 40 °C (104 °F) ambient and rated line voltage. For additional information on ambient and line conditions, refer to Motion Analyzer software.

Performance Specifications with Frame 50 Linear Thruster

Linear Thruster Cat. No.	Velocity, max 230V AC m/s	System Continuous Stall Current Amps 0-pk	System Continuous Stall Force N (lb)	System Peak Stall Current Amps 0-pk	System Peak Stall Force N (lb)	Rated Output 230V AC kW	Kinetix 5500 Drives (240V AC input)
LDAT-S051010-DDx	2.8	3.1	119 (27)	11.4	363 (82)	0.31	2198-H015-ERSx
LDAT-S051020-DDx	3.7					0.38	
LDAT-S051030-DDx	4.1					0.42	
LDAT-S051040-DDx	4.4					0.44	
LDAT-S051050-DDx	4.7					0.46	
LDAT-S052010-DDx	3.7	6.2	251 (56)	22.7	727 (163)	0.79	2198-H025-ERSx
LDAT-S052020-DDx	4.8					0.97	
LDAT-S052030-DDx	5.0					1.01	
LDAT-S052040-DDx						1.01	
LDAT-S052050-DDx		1.01					
LDAT-S052010-EDx ... LDAT-S052050-EDx	2.6	3.1		11.4		0.50	2198-H015-ERSx

Performance Specifications with Frame 50 Linear Thruster (cont.)

Linear Thruster Cat. No.	Velocity, max 230V AC m/s	System Continuous Stall Current Amps 0-pk	System Continuous Stall Force N (lb)	System Peak Stall Current Amps 0-pk	System Peak Stall Force N (lb)	Rated Output 230V AC kW	Kinetix 5500 Drives (240V AC input)
LDAT-S053010-DDx	4.1	9.4	378 (85)	34.2	1093 (246)	1.31	2198-H040-ERSx
LDAT-S053020-DDx	5.0					1.53	
LDAT-S053030-DDx ... LDAT-S053050-DDx	5.0					1.53	
LDAT-S053010-EDx ... LDAT-S053050-EDx	1.7	3.1		11.4		0.47	2198-H015-ERSx
LDAT-S054010-DDx	4.4	12.4	509 (114)	45.5	1453 (327)	1.87	2198-H040-ERSx
LDAT-S054020-DDx ... LDAT-S054050-DDx	5.0					2.05	
LDAT-S054010-EDx ... LDAT-S054050-EDx	2.6					6.2	22.7

Performance specification data and curves reflect nominal system performance of a typical system with motor at 40 °C (104 °F) and drive at 40 °C (104 °F) ambient and rated line voltage. For additional information on ambient and line conditions, refer to Motion Analyzer software.

Performance Specifications with Frame 70 Linear Thrusters

Linear Thruster Cat. No.	Velocity, max 230V AC m/s	System Continuous Stall Current Amps 0-pk	System Continuous Stall Force N (lb)	System Peak Stall Current Amps 0-pk	System Peak Stall Force N (lb)	Rated Output 230V AC kW	Kinetix 5500 Drives (240V AC input)
LDAT-S072010-DDx ... LDAT-S072070-DDx	3.5	6.0	364 (82)	22.0	1055 (237)	1.03	2198-H025-ERSx
LDAT-S072010-EDx ... LDAT-S072070-EDx	1.7	3.0		11.0		0.47	2198-H015-ERSx
LDAT-S073010-DDx ... LDAT-S073070-DDx	3.5	9.0	554 (125)	32.8	1576 (354)	1.57	2198-H040-ERSx
LDAT-S073010-EDx ... LDAT-S073070-EDx	1.2	3.0		10.9		0.41	2198-H015-ERSx
LDAT-S074010-DDx ... LDAT-S074070-DDx	3.5	11.9	730 (164)	43.5	2088 (469)	2.08	2198-H040-ERSx
LDAT-S074010-EDx ... LDAT-S074070-EDx	1.8	6.0		21.7		0.95	2198-H025-ERSx
LDAT-S076010-DDx ... LDAT-S076070-DDx	3.5	18.2	1122 (252)	66.4	3189 (717)	3.17	2198-H070-ERSx
LDAT-S076010-EDx ... LDAT-S076070-EDx	1.8	9.1		33.2		1.45	2198-H040-ERSx

Performance specification data and curves reflect nominal system performance of a typical system with motor at 40 °C (104 °F) and drive at 40 °C (104 °F) ambient and rated line voltage. For additional information on ambient and line conditions, refer to Motion Analyzer software.

Performance Specifications with Frame 100 Linear Thrusters

Linear Thruster Cat. No.	Velocity, max 230V AC m/s	System Continuous Stall Current Amps 0-pk	System Continuous Stall Force N (lb)	System Peak Stall Current Amps 0-pk	System Peak Stall Force N (lb)	Rated Output 230V AC kW	Kinetix 5500 Drives (240V AC input)
LDAT-S102010-DDx ... LDAT-S102090-DDx	2.6	5.7	456 (103)	21.0	1289 (290)	0.96	2198-H025-ERSx
LDAT-S102010-EDx ... LDAT-S102090-EDx	1.3	2.9		10.5		0.42	2198-H015-ERSx
LDAT-S103010-DDx ... LDAT-S103090-DDx	2.7	8.6	702 (158)	31.5	1935 (435)	1.47	2198-H040-ERSx
LDAT-S103010-EDx ... LDAT-S103090-EDx	0.9	2.9		10.5	1388 (312)	0.30	2198-H015-ERSx
LDAT-S104010-DDx ... LDAT-S104090-DDx	2.7	11.5	929 (209)	42.0	2578 (580)	2.07	2198-H040-ERSx
LDAT-S104010-EDx ... LDAT-S104090-EDx	1.3	5.7		21.0		0.86	2198-H025-ERSx
LDAT-S106010-DDx ... LDAT-S106090-DDx	2.7	17.3	1403 (315)	63.0	3871 (870)	2.94	2198-H070-ERSx
LDAT-S106010-EDx ... LDAT-S106090-EDx	1.3	8.6		31.5		1.28	2198-H040-ERSx

Performance specification data and curves reflect nominal system performance of a typical system with motor at 40 °C (104 °F) and drive at 40 °C (104 °F) ambient and rated line voltage. For additional information on ambient and line conditions, refer to Motion Analyzer software.

Performance Specifications with Frame 150 Linear Thrusters

Linear Thruster Cat. No.	Velocity, max 230V AC m/s	System Continuous Stall Current Amps 0-pk	System Continuous Stall Force N (lb)	System Peak Stall Current Amps 0-pk	System Peak Stall Force N (lb)	Rated Output 230V AC kW	Kinetix 5500 Drives (240V AC input)
LDAT-S152010-DDx ... LDAT-S152090-DDx	1.8	5.3	643 (145)	19.5	1799 (404)	0.87	2198-H025-ERSx
LDAT-S152010-EDx ... LDAT-S152090-EDx	0.9	2.7		9.8	1679 (377)	0.34	2198-H015-ERSx
LDAT-S153010-DDx ... LDAT-S153090-DDx	1.8	8.0	978 (220)	29.1	2680 (602)	1.33	2198-H040-ERSx
LDAT-S154010-DDx ... LDAT-S154090-DDx	1.8	10.7	1306 (294)	39.1	3597 (809)	1.78	2198-H040-ERSx
LDAT-S154010-EDx ... LDAT-S154090-EDx	0.9	5.3		19.5	3383 (761)	0.70	2198-H025-ERSx
LDAT-S156010-DDx ... LDAT-S156090-DDx	1.8	16.3	1997 (449)	59.4	5469 (1229)	2.71	2198-H070-ERSx
LDAT-S156010-EDx ... LDAT-S156090-EDx	0.9	8.1		19.8	5110 (1149)	1.05	2198-H025-ERSx

Performance specification data and curves reflect nominal system performance of a typical system with motor at 40 °C (104 °F) and drive at 40 °C (104 °F) ambient and rated line voltage. For additional information on ambient and line conditions, refer to Motion Analyzer software.

Kinetix 5500 (200V-class operation) Drives/LDAT-Series Integrated Linear Thruster Curves

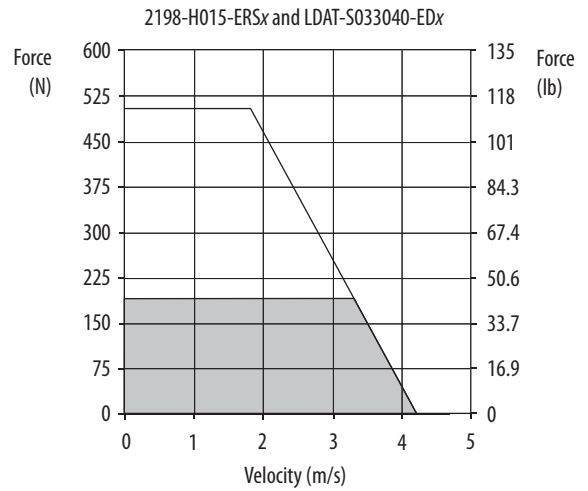
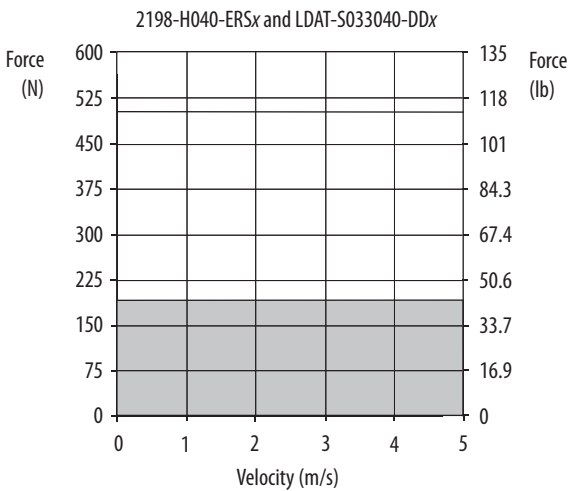
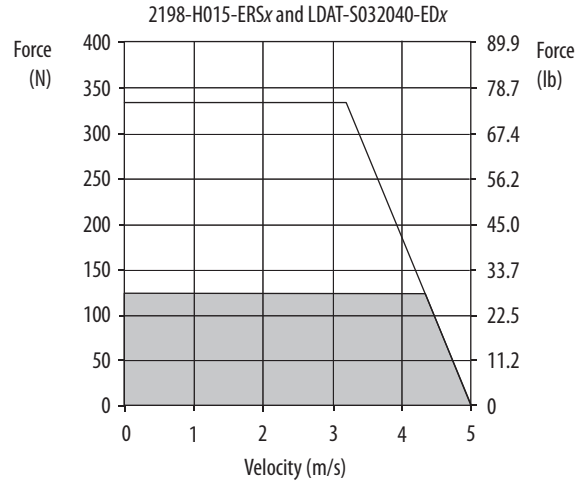
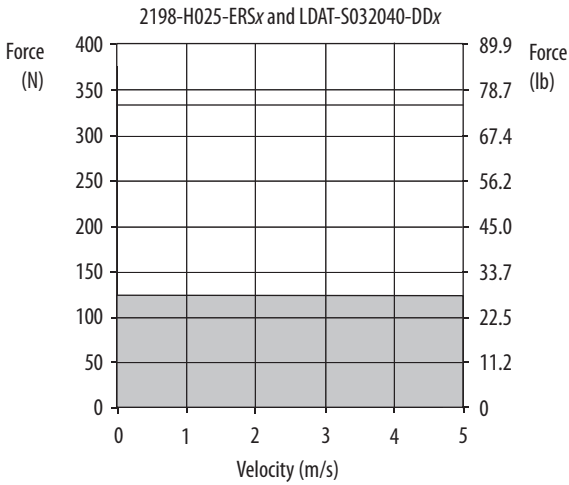
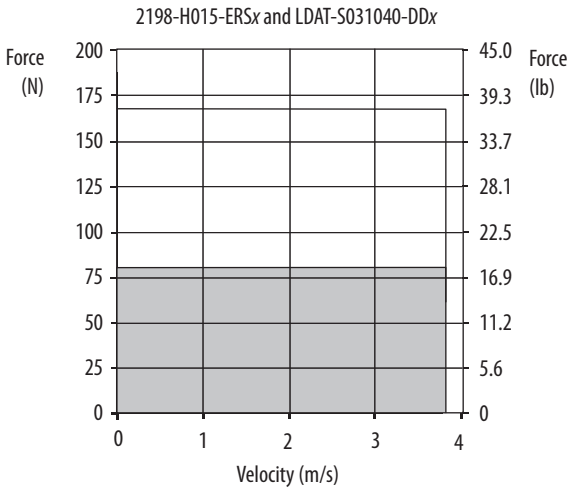

= Intermittent operating region
 = Continuous operating region

Kinetix 5500 (200V-class operation) Drives/LDAT-Series Integrated Linear Thruster Curves (continued)

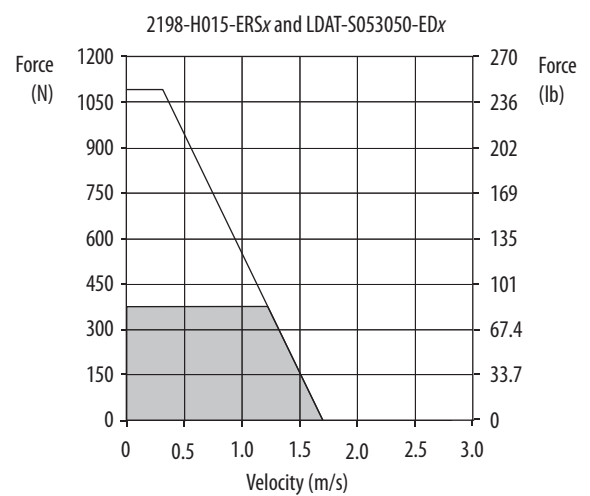
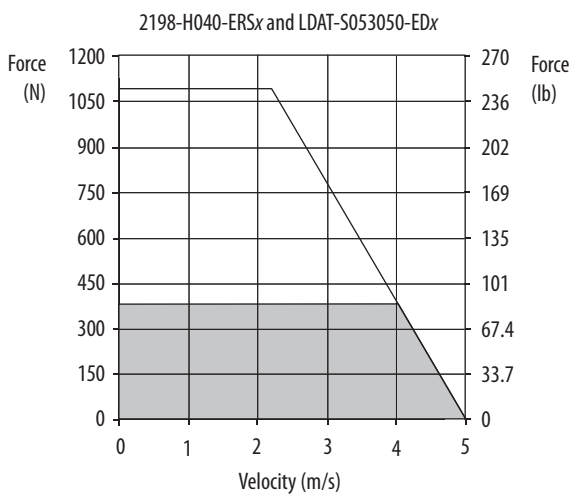
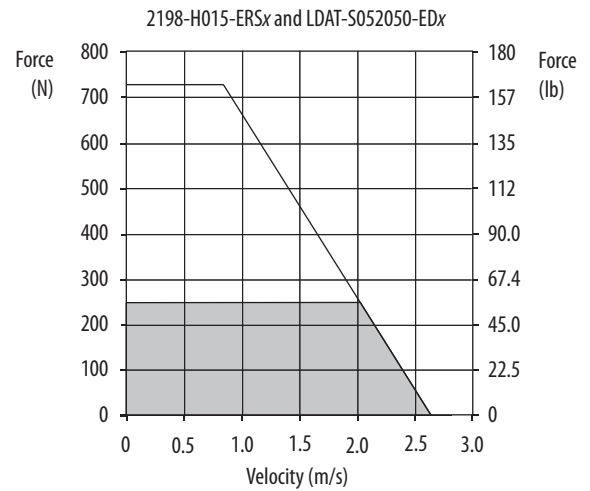
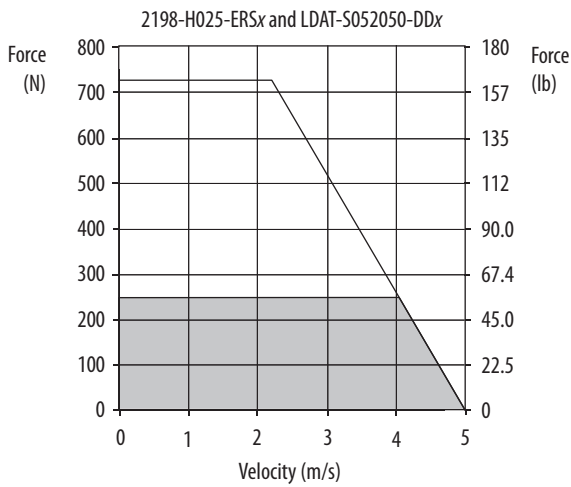
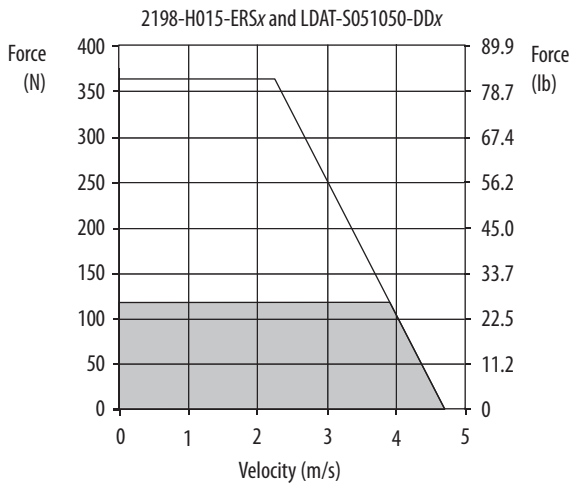

= Intermittent operating region
 = Continuous operating region

Kinetix 5500 (200V-class operation) Drives/LDAT-Series Integrated Linear Thruster Curves (continued)

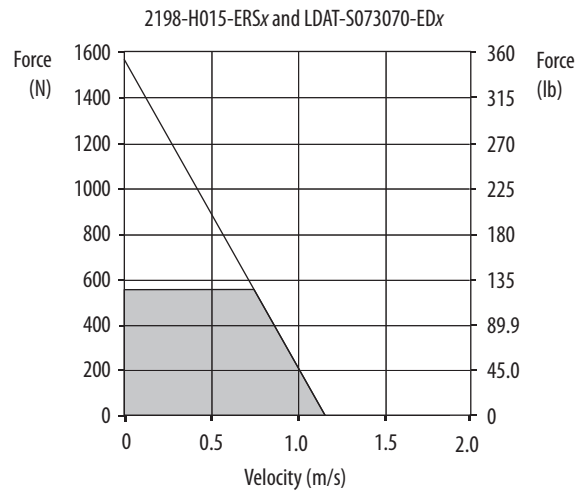
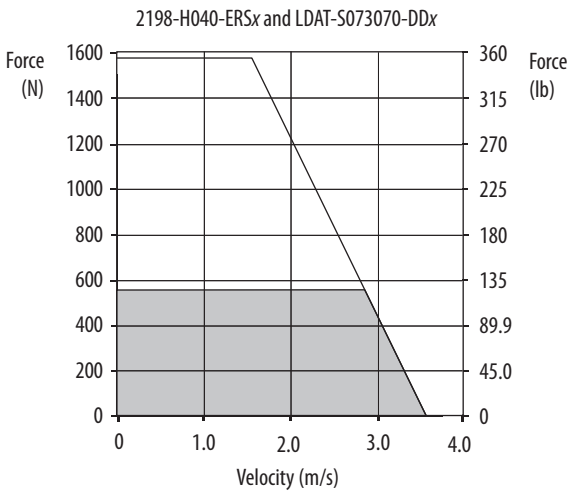
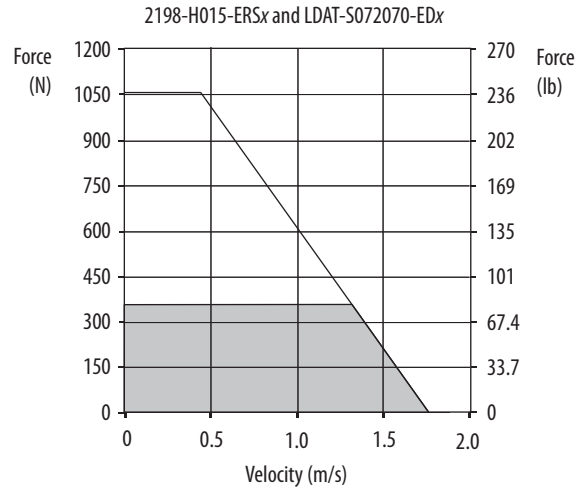
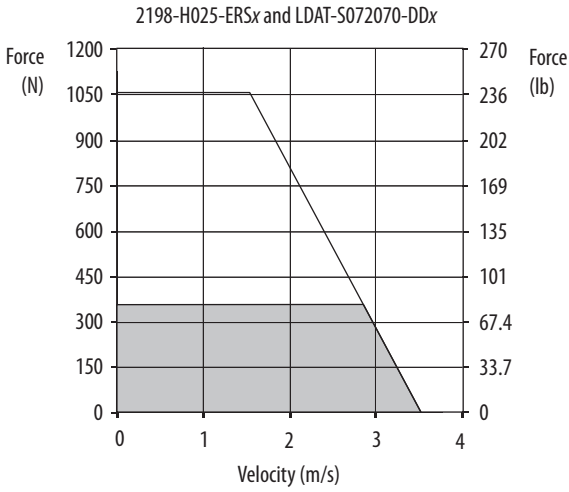
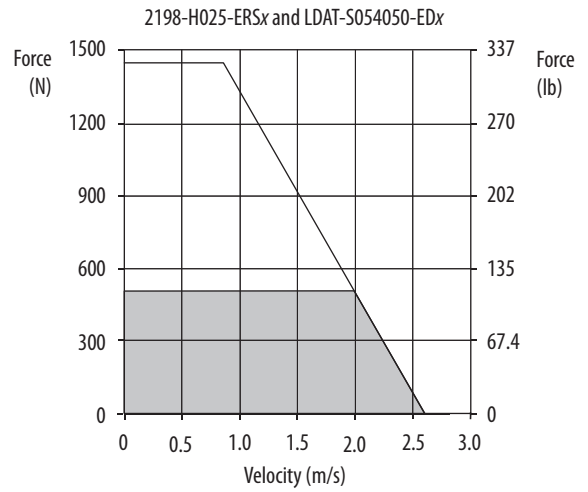
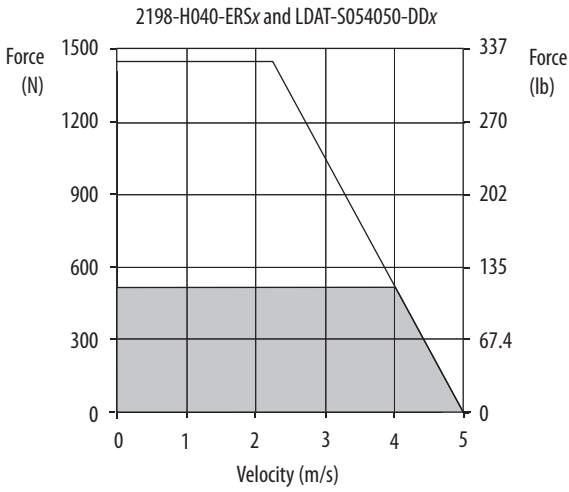

= Intermittent operating region
 = Continuous operating region

Kinetix 5500 (200V-class operation) Drives/LDAT-Series Integrated Linear Thruster Curves (continued)

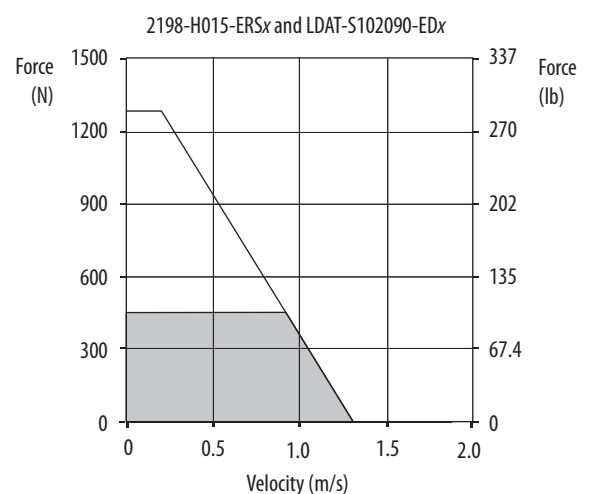
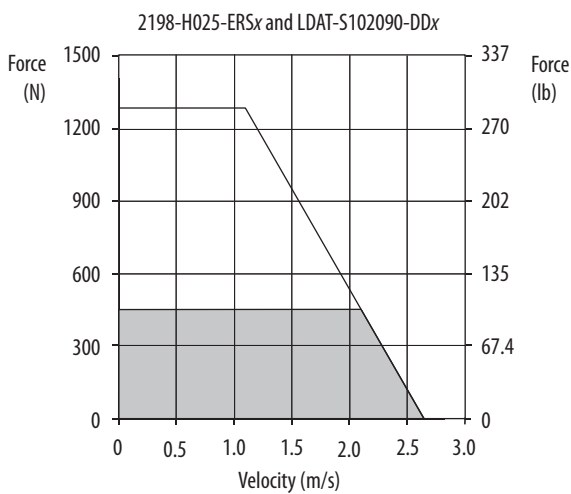
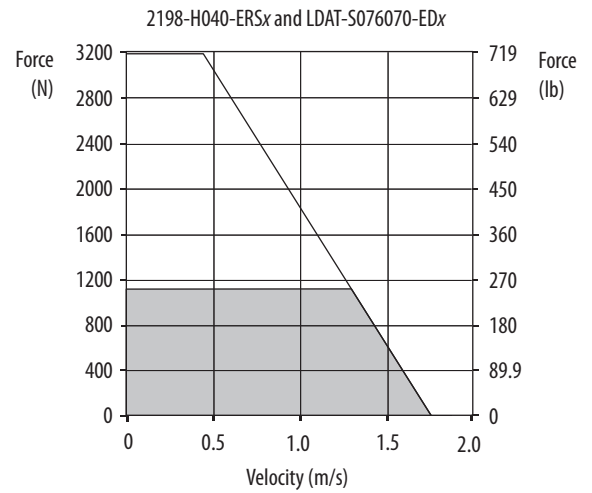
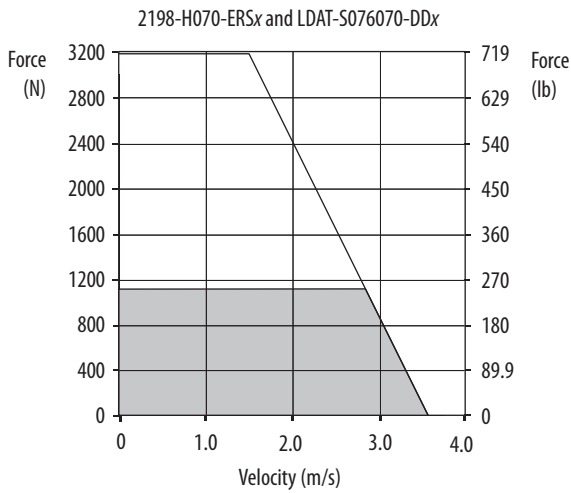
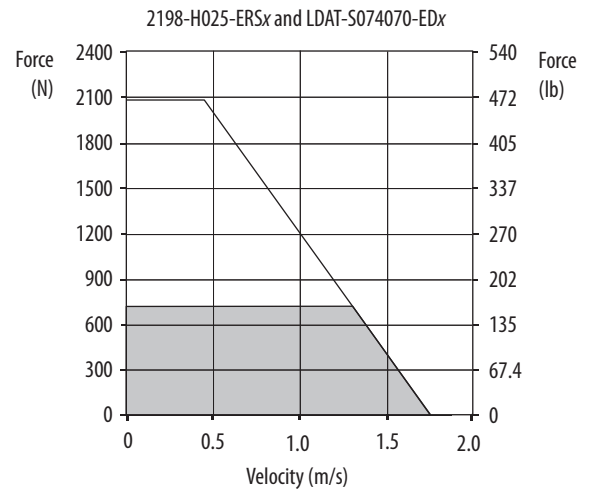
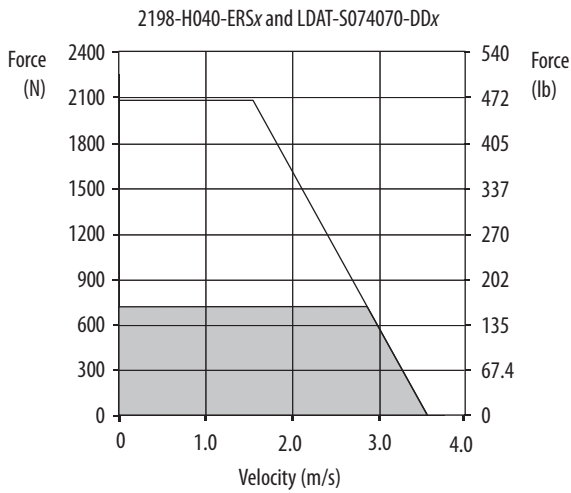

= Intermittent operating region
 = Continuous operating region

Kinetix 5500 (200V-class operation) Drives/LDAT-Series Integrated Linear Thruster Curves (continued)

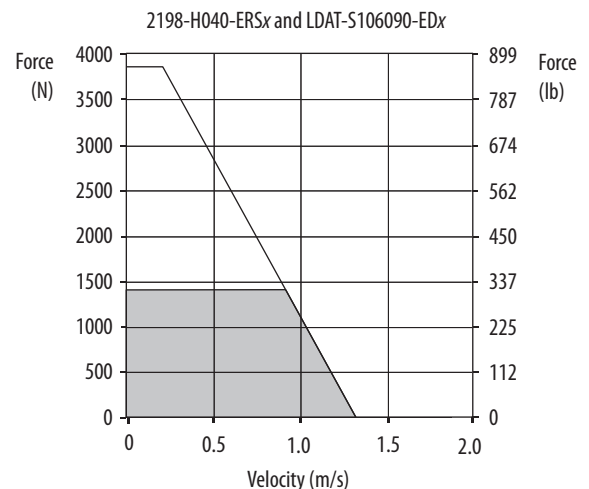
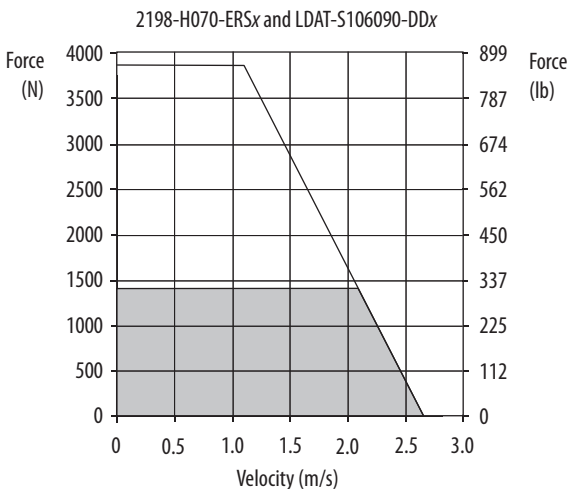
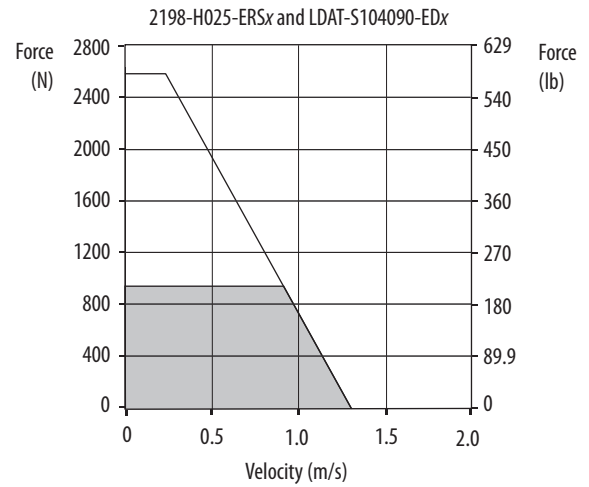
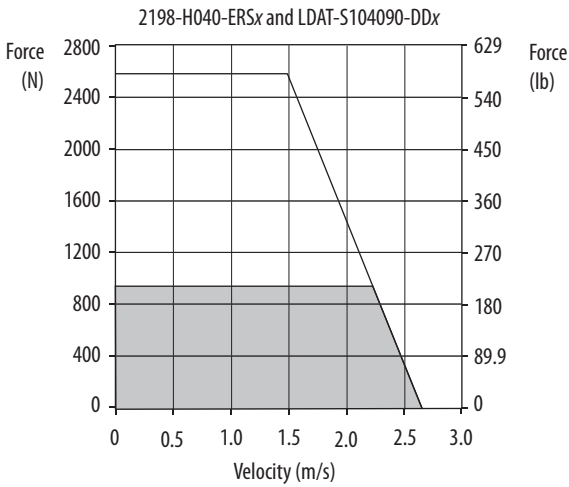
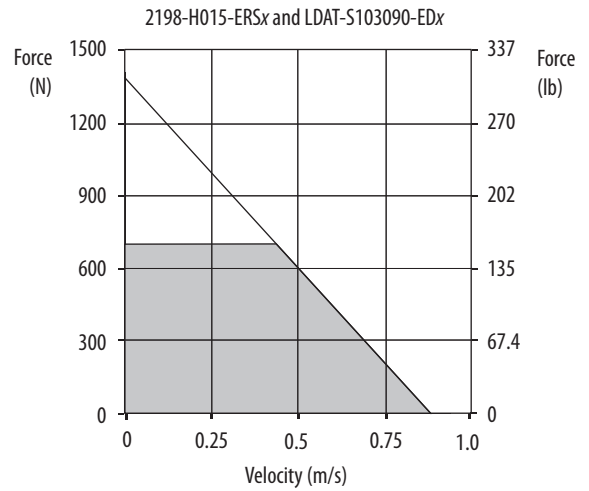
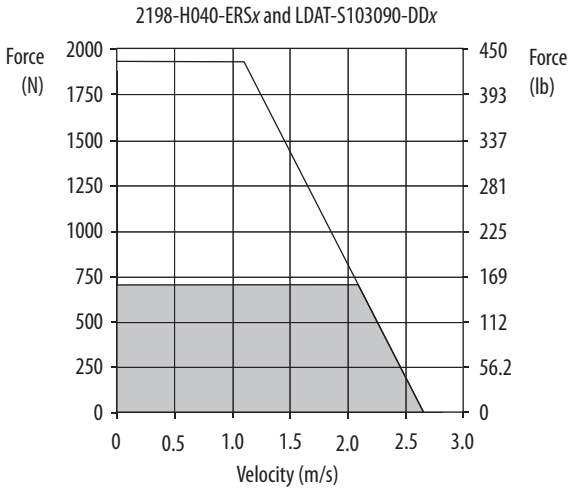

□ = Intermittent operating region
 ■ = Continuous operating region

Kinetix 5500 (200V-class operation) Drives/LDAT-Series Integrated Linear Thruster Curves (continued)

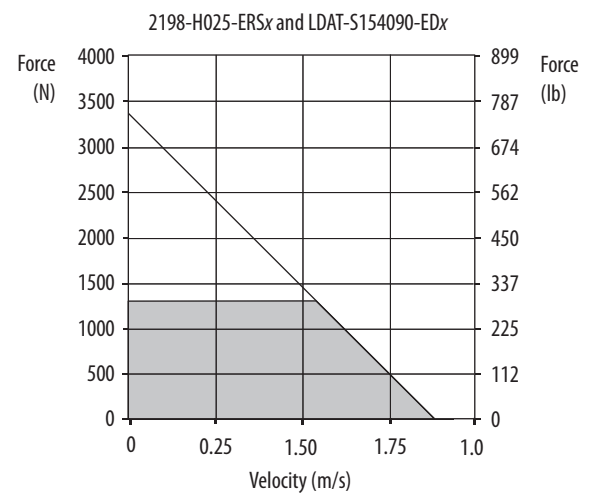
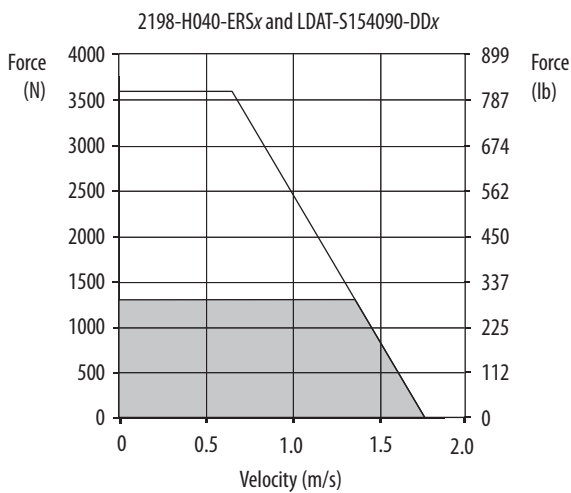
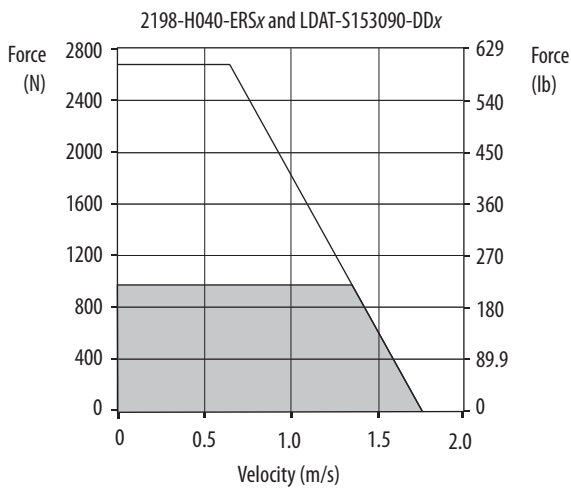
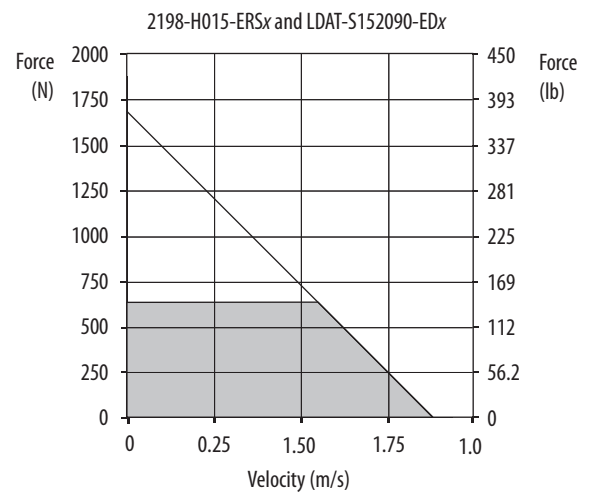
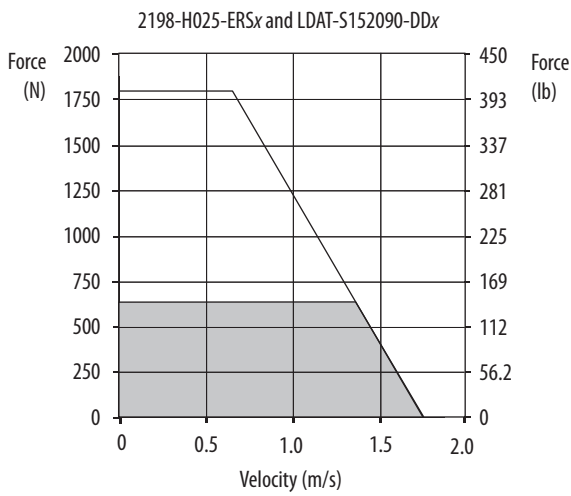

= Intermittent operating region
 = Continuous operating region

Kinetix 5500 (200V-class operation) Drives/LDAT-Series Integrated Linear Thruster Curves (continued)

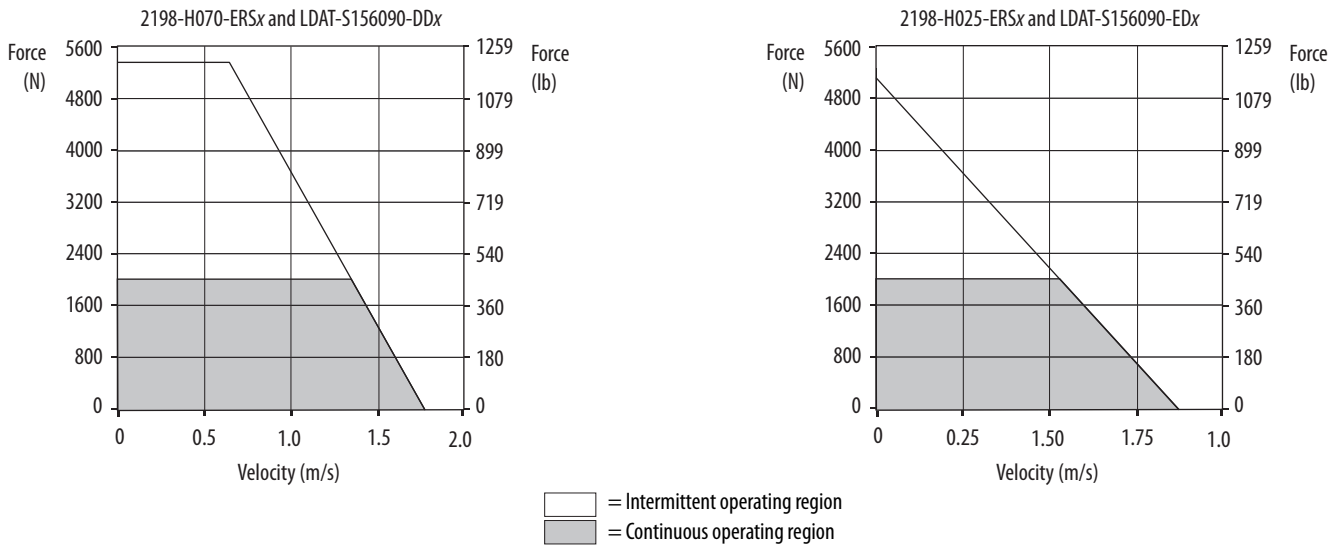

LDAT-Series Performance Specifications with Kinetix 5500 (400V-class operation) Drives

Performance Specifications with Frame 30 Linear Thrusters

Linear Thruster Cat. No.	Velocity, max 460V AC m/s	System Continuous Stall Current Amps 0-pk	System Continuous Stall Force N (lb)	System Peak Stall Current Amps 0-pk	System Peak Stall Force N (lb)	Rated Output 460V AC kW	Kinetix 5500 Drives (480V AC input)
LDAT-S031010-DDx	2.4	4.8	81 (18)	12.2	168 (38)	0.20	2198-H015-ERSx
LDAT-S031020-DDx	3.1					0.25	
LDAT-S031030-DDx	3.5					0.29	
LDAT-S031040-DDx	3.8					0.31	
LDAT-S032010-DDx	3.1	7.4	126 (28)	24.3	336 (76)	0.40	2198-H025-ERSx
LDAT-S032020-DDx	4.1					0.52	
LDAT-S032030-DDx	4.7					0.59	
LDAT-S032040-DDx	5.0					0.63	
LDAT-S032010-EDx	3.1	3.7	190 (43)	12.2	504 (113)	0.40	2198-H015-ERSx
LDAT-S032020-EDx	4.1					0.52	
LDAT-S032030-EDx	4.7					0.59	
LDAT-S032040-EDx	5.0					0.63	
LDAT-S033010-DDx	3.5	11.1	190 (43)	36.5	504 (113)	0.67	2198-H040-ERSx
LDAT-S033020-DDx	4.7					0.88	
LDAT-S033030-DDx	5.0					0.95	
LDAT-S033040-DDx							
LDAT-S033010-EDx	3.5	3.7	190 (43)	12.2	504 (113)	0.67	2198-H015-ERSx
LDAT-S033020-EDx	4.7					0.87	
LDAT-S033030-EDx	5.0					0.91	
LDAT-S033040-EDx							

Performance specification data and curves reflect nominal system performance of a typical system with motor at 40 °C (104 °F) and drive at 40 °C (104 °F) ambient and rated line voltage. For additional information on ambient and line conditions, refer to Motion Analyzer software.

Performance Specifications with Frame 50 Linear Thrusters

Linear Thruster Cat. No.	Velocity, max 460V AC m/s	System Continuous Stall Current Amps 0-pk	System Continuous Stall Force N (lb)	System Peak Stall Current Amps 0-pk	System Peak Stall Force N (lb)	Rated Output 460V AC kW	Kinetix 5500 Drives (480V AC input)
LDAT-S051010-DDx	2.8	3.1	119 (27)	11.4	363 (82)	0.34	2198-H015-ERSx
LDAT-S051020-DDx	3.7					0.43	
LDAT-S051030-DDx	4.1					0.49	
LDAT-S051040-DDx	4.4					0.53	
LDAT-S051050-DDx	4.7					0.55	
LDAT-S052010-DDx	3.7	6.2	251 (56)	22.7	727 (163)	0.92	2198-H025-ERSx
LDAT-S052020-DDx	4.8					1.20	
LDAT-S052030-DDx	5.0					1.24	
LDAT-S052040-DDx						0.80	
LDAT-S052050-DDx							
LDAT-S052010-EDx	3.7	3.1	251 (56)	11.4	727 (163)	1.02	2198-H015-ERSx
LDAT-S052020-EDx	4.6					0.80	
LDAT-S052030-EDx	4.6					0.98	
LDAT-S052040-EDx						1.02	
LDAT-S052050-EDx							
LDAT-S053010-DDx	4.1	9.4	378 (85)	34.2	1093 (246)	1.87	2198-H040-ERSx
LDAT-S053020-DDx	5.0					1.56	
LDAT-S053030-DDx ... LDAT-S053050-DDx						1.87	
LDAT-S053010-EDx ... LDAT-S053050-EDx	3.5	3.1	378 (85)	11.4	1093 (246)	1.04	2198-H015-ERSx
LDAT-S054010-DDx	4.4	12.4	509 (114)	45.5	1453 (327)	2.26	2198-H040-ERSx
LDAT-S054020-DDx ... LDAT-S054050-DDx	5.00					2.53	
LDAT-S054010-EDx	4.4					1.87	
LDAT-S054020-EDx ... LDAT-S054050-EDx	5.0	6.2	509 (114)	22.7	1453 (327)	2.05	2198-H025-ERSx

Performance specification data and curves reflect nominal system performance of a typical system with motor at 40 °C (104 °F) and drive at 40 °C (104 °F) ambient and rated line voltage. For additional information on ambient and line conditions, refer to Motion Analyzer software.

Performance Specifications with Frame 70 Linear Thrusters

Linear Thruster Cat. No.	Velocity, max 460V AC m/s	System Continuous Stall Current Amps 0-pk	System Continuous Stall Force N (lb)	System Peak Stall Current Amps 0-pk	System Peak Stall Force N (lb)	Rated Output 460V AC kW	Kinetix 5500 Drives (480V AC input)
LDAT-S072010-DDx	3.9	6.0	364 (82)	22.0	1055 (237)	1.37	2198-H025-ERSx
LDAT-S072020-DDx	5.0					1.64	
LDAT-S072030-DDx ... LDAT-S072070-DDx							
LDAT-S072010-EDx	3.5	3.0		11.0		1.03	2198-H015-ERSx
LDAT-S072020-EDx							
LDAT-S072070-EDx							
LDAT-S073010-DDx	4.4	9.0	554 (125)	32.8	1576 (354)	2.27	2198-H040-ERSx
LDAT-S073020-DDx	5.0					2.50	
LDAT-S073070-DDx							
LDAT-S073010-EDx	2.4	3.0		10.9		1.01	2198-H015-ERSx
LDAT-S073070-EDx							
LDAT-S074010-DDx						4.7	
LDAT-S074020-DDx	5.0	3.30					
LDAT-S074070-DDx							
LDAT-S074010-EDx	3.5	6.0		21.7		2.08	2198-H025-ERSx
LDAT-S074070-EDx							
LDAT-S076010-DDx						5.0	
LDAT-S076020-DDx							
LDAT-S076070-DDx							
LDAT-S076010-EDx	3.5	9.1		33.2		3.18	2198-H040-ERSx
LDAT-S076070-EDx							

Performance specification data and curves reflect nominal system performance of a typical system with motor at 40 °C (104 °F) and drive at 40 °C (104 °F) ambient and rated line voltage. For additional information on ambient and line conditions, refer to Motion Analyzer software.

Performance Specifications with Frame 100 Linear Thrusters

Linear Thruster Cat. No.	Velocity, max 460V AC m/s	System Continuous Stall Current Amps 0-pk	System Continuous Stall Force N (lb)	System Peak Stall Current Amps 0-pk	System Peak Stall Force N (lb)	Rated Output 460V AC kW	Kinetix 5500 Drives (480V AC input)
LDAT-S102010-DDx	3.4	5.7	456 (103)	21.0	1289 (290)	1.44	2198-H025-ERSx
LDAT-S102020-DDx	4.4					1.74	
LDAT-S102030-DDx	5.0					1.91	
LDAT-S102040-DDx							
LDAT-S102050-DDx ... LDAT-S102090-DDx							
LDAT-S102010-EDx ... LDAT-S102090-EDx	2.6	2.9	10.5	0.96	2198-H015-ERSx		
LDAT-S103010-DDx	3.8	8.6	702 (158)	31.5	1935 (435)	2.41	2198-H040-ERSx
LDAT-S103020-DDx	5.0					2.93	
LDAT-S103030-DDx ... LDAT-S103090-DDx							
LDAT-S103010-EDx ... LDAT-S103090-EDx	1.8	2.9	10.5	0.92	2198-H015-ERSx		
LDAT-S104010-DDx	4.1	11.5	929 (209)	42.0	2578 (580)	3.76	2198-H040-ERSx
LDAT-S104020-DDx	5.0					4.29	
LDAT-S104030-DDx ... LDAT-S104090-DDx							
LDAT-S104010-EDx ... LDAT-S104090-EDx	2.7	5.7	21.0	2.07	2198-H025-ERSx		
LDAT-S106010-DDx	4.5	17.3	1403 (315)	63.0	3871 (870)	5.41	2198-H070-ERSx
LDAT-S106020-DDx ... LDAT-S106090-DDx	5.0					5.87	
LDAT-S106010-EDx ... LDAT-S106090-EDx	2.7	8.6				31.5	2.94

Performance specification data and curves reflect nominal system performance of a typical system with motor at 40 °C (104 °F) and drive at 40 °C (104 °F) ambient and rated line voltage. For additional information on ambient and line conditions, refer to Motion Analyzer software.

Performance Specifications with Frame 150 Linear Thrusters

Linear Thruster Cat. No.	Velocity, max 460V AC m/s	System Continuous Stall Current Amps 0-pk	System Continuous Stall Force N (lb)	System Peak Stall Current Amps 0-pk	System Peak Stall Force N (lb)	Rated Output 460V AC kW	Kinetix 5500 Drives (480V AC input)
LDAT-S152010-DDx	3.2	5.3	643 (145)	19.5	1799 (404)	1.76	2198-H025-ERSx
LDAT-S152020-DDx ... LDAT-S152090-DDx	3.5					1.89	
LDAT-S152010-EDx ... LDAT-S152090-EDx	1.8			2.7		9.8	0.87
LDAT-S153010-DDx ... LDAT-S153090-DDx	3.6	8.0	978 (220)	29.1	2680 (602)	2.87	2198-H040-ERSx
LDAT-S153010-EDx ... LDAT-S153090-EDx	1.2	2.7		9.1		0.80	2198-H015-ERSx
LDAT-S154010-DDx ... LDAT-S154090-DDx	3.5	10.7	1306 (294)	39.1	3597 (809)	3.83	2198-H040-ERSx
LDAT-S154010-EDx ... LDAT-S154090-EDx	1.8	5.3		19.5		1.78	2198-H025-ERSx
LDAT-S156010-DDx ... LDAT-S156090-DDx	3.6	16.3	1997 (449)	59.4	5469 (1229)	5.85	2198-H070-ERSx
LDAT-S156010-EDx ... LDAT-S156090-EDx	1.8	8.1		19.8		2.71	2198-H025-ERSx

Performance specification data and curves reflect nominal system performance of a typical system with motor at 40 °C (104 °F) and drive at 40 °C (104 °F) ambient and rated line voltage. For additional information on ambient and line conditions, refer to Motion Analyzer software.

Kinetix 5500 (400V-class operation) Drives/LDAT-Series Integrated Linear Thruster Curves

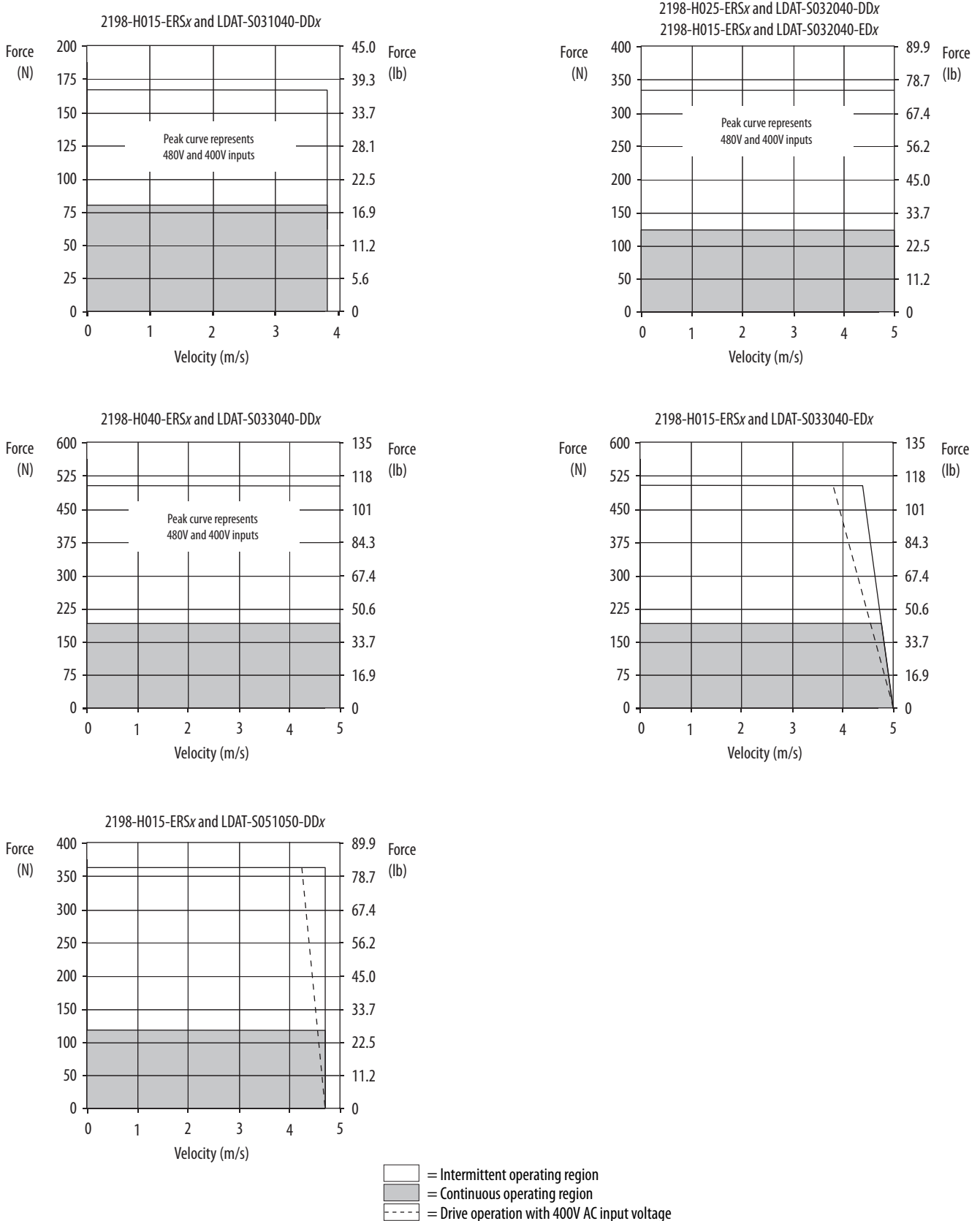

Kinetix 5500 (400V-class operation) Drives/LDAT-Series Linear Thruster Curves (continued)

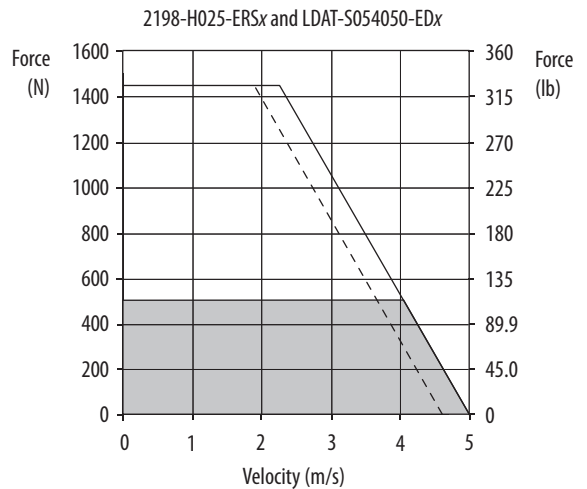
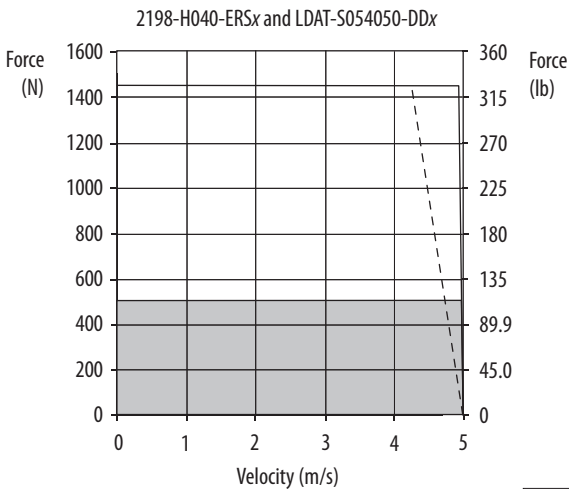
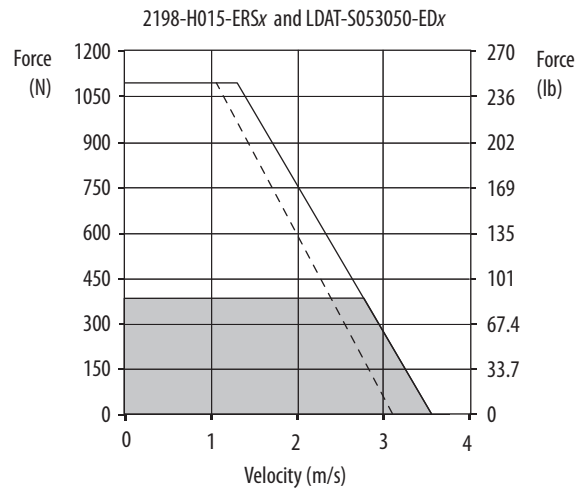
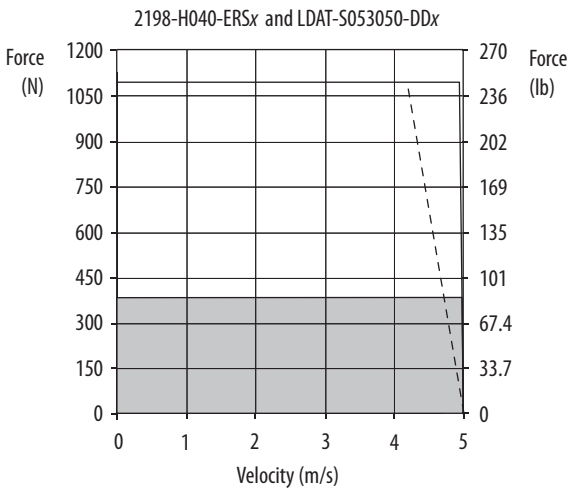
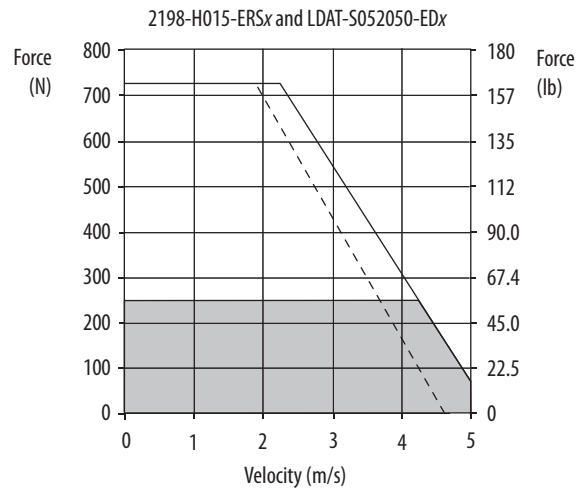
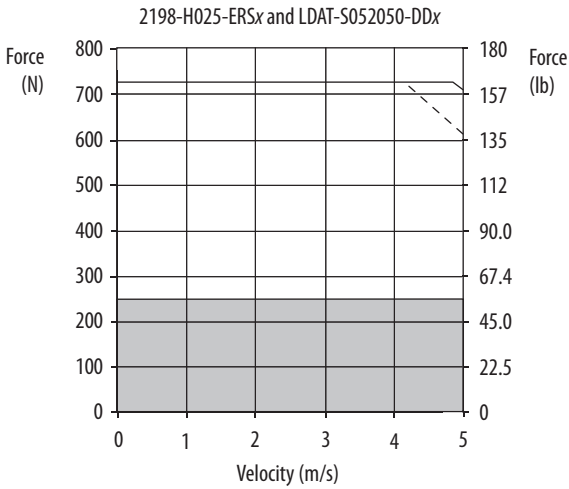

= Intermittent operating region
 = Continuous operating region
 = Drive operation with 400V AC input voltage

Kinetix 5500 (400V-class operation) Drives/LDAT-Series Linear Thruster Curves (continued)

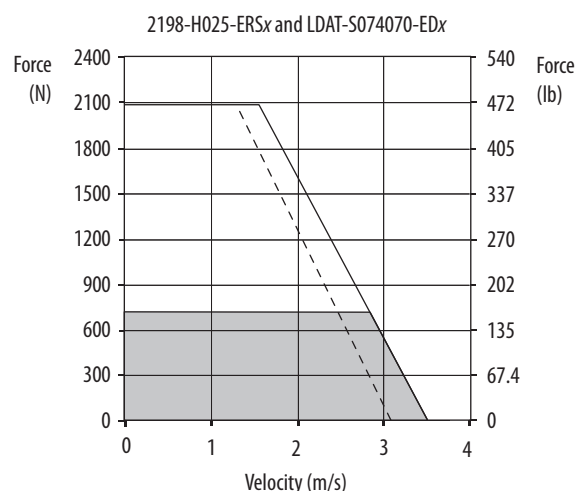
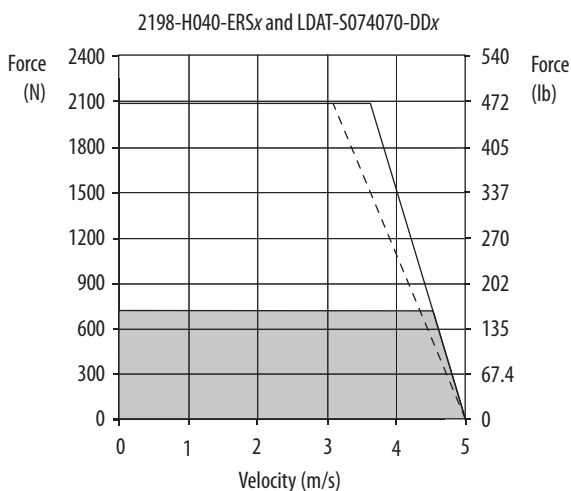
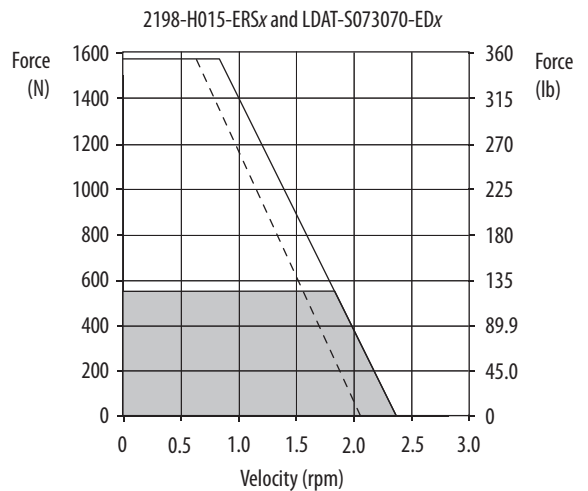
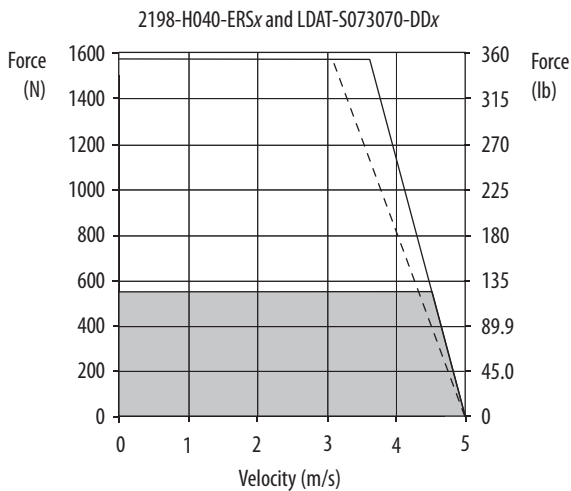
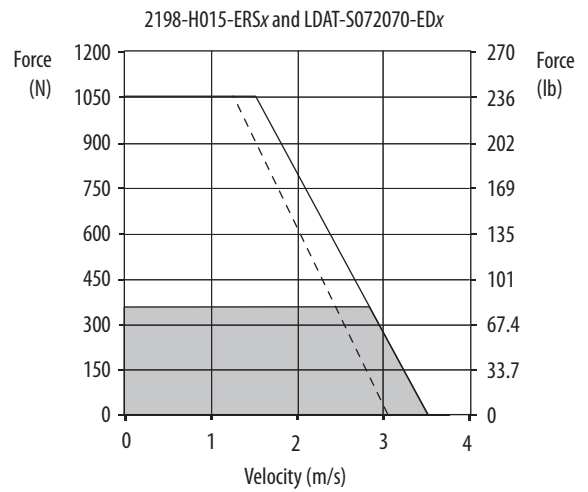
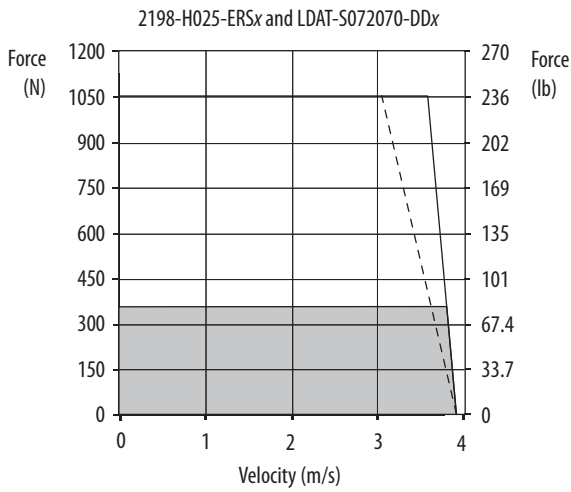

- = Intermittent operating region
- = Continuous operating region
- = Drive operation with 400V AC input voltage

Kinetix 5500 (400V-class operation) Drives/LDAT-Series Linear Thruster Curves (continued)

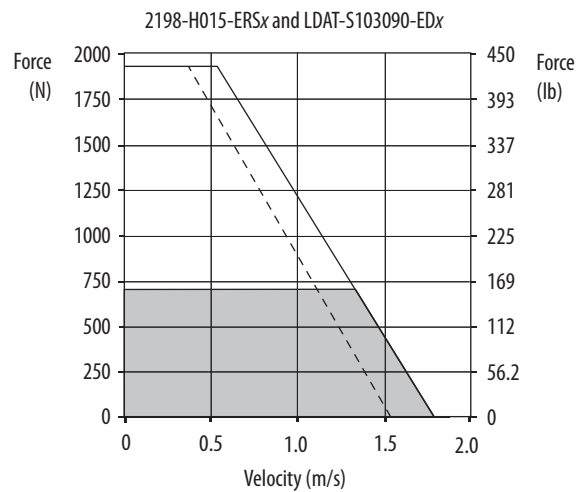
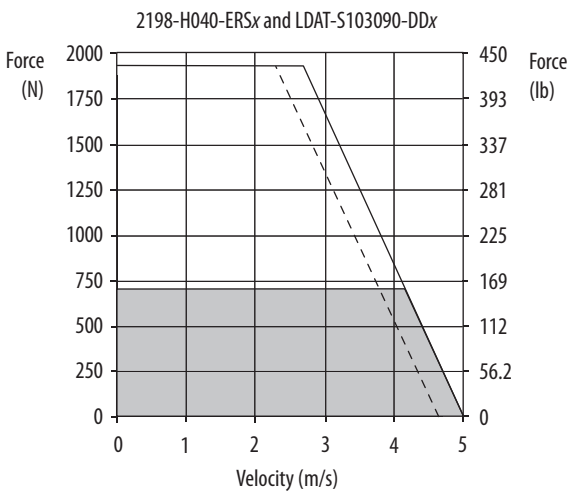
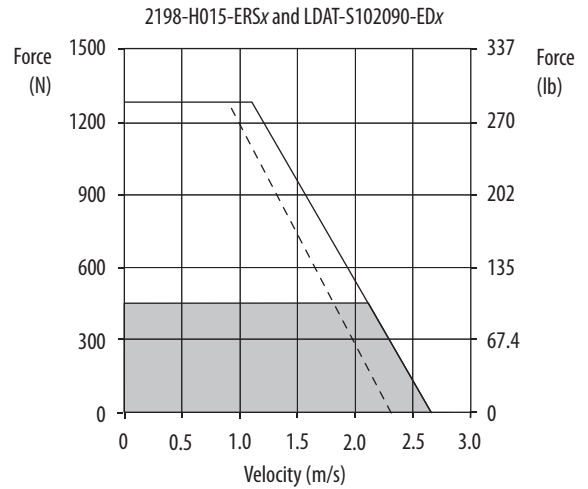
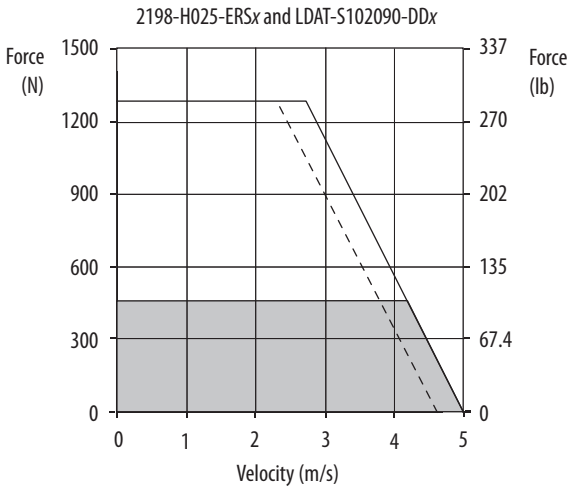
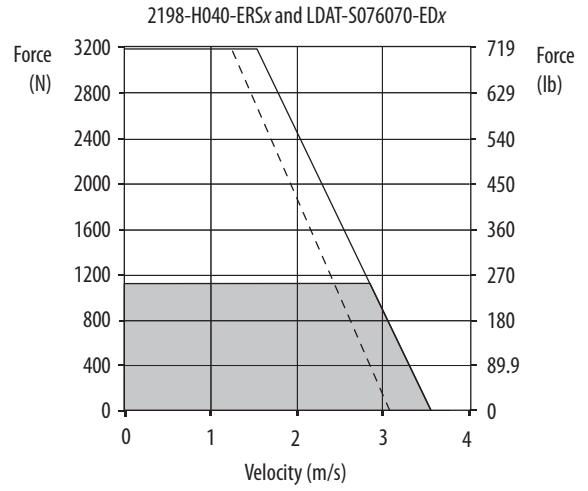
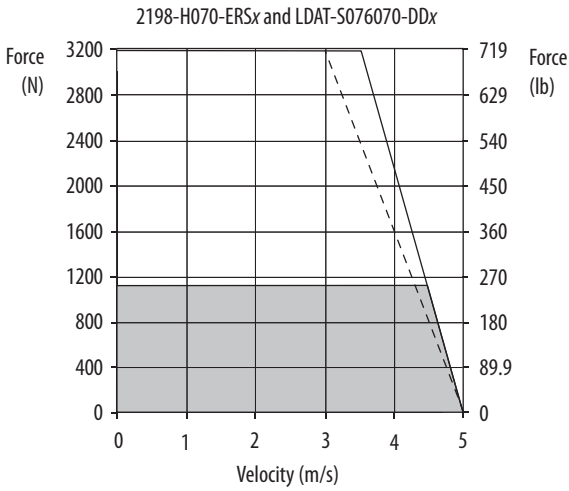

= Intermittent operating region
 = Continuous operating region
 = Drive operation with 400V AC input voltage

Kinetix 5500 (400V-class operation) Drives/LDAT-Series Linear Thruster Curves (continued)

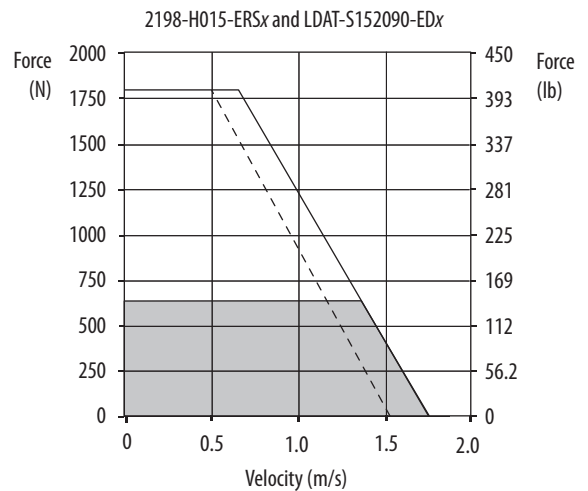
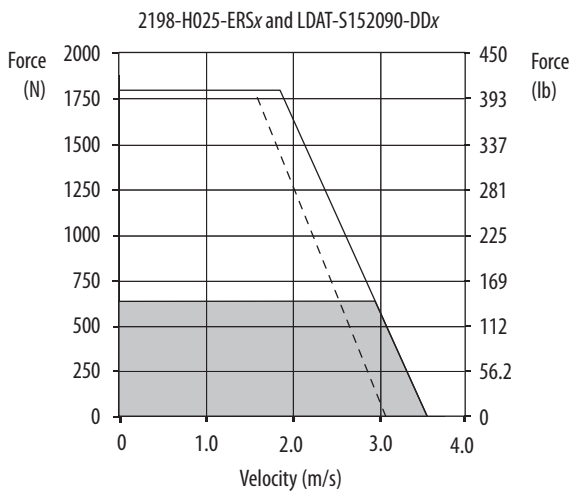
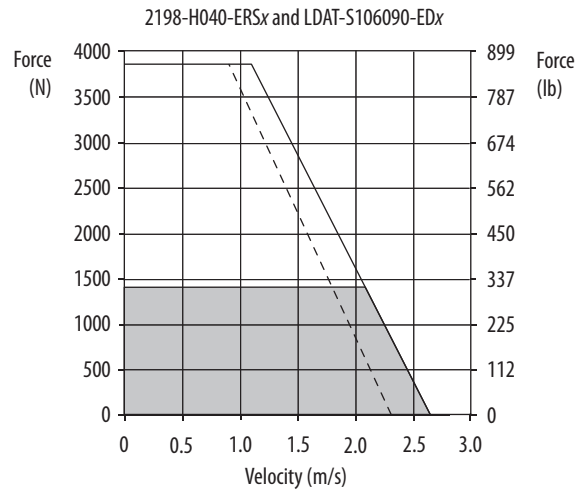
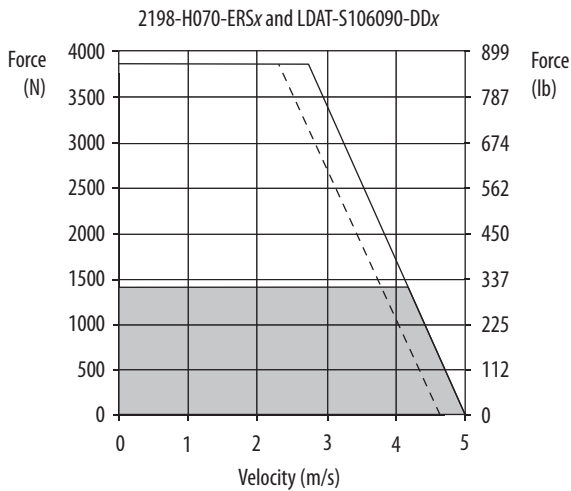
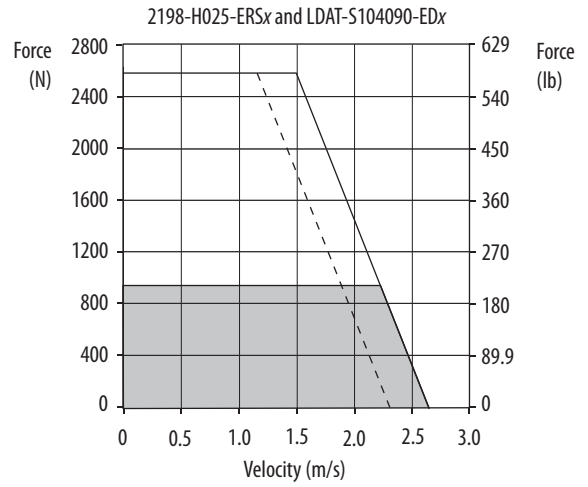
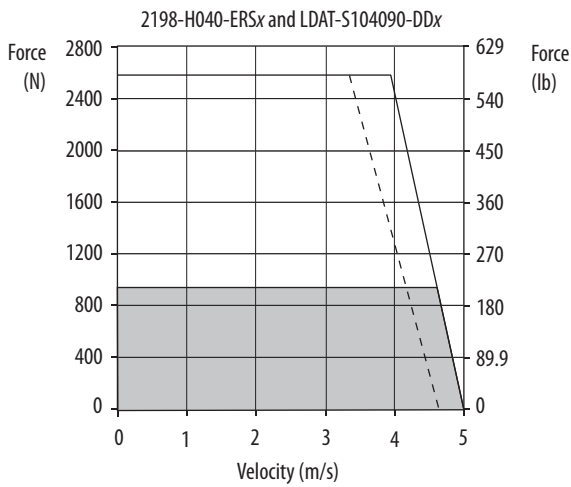

- = Intermittent operating region
- = Continuous operating region
- = Drive operation with 400V AC input voltage

Kinetix 5500 (400V-class operation) Drives/LDAT-Series Linear Thruster Curves (continued)

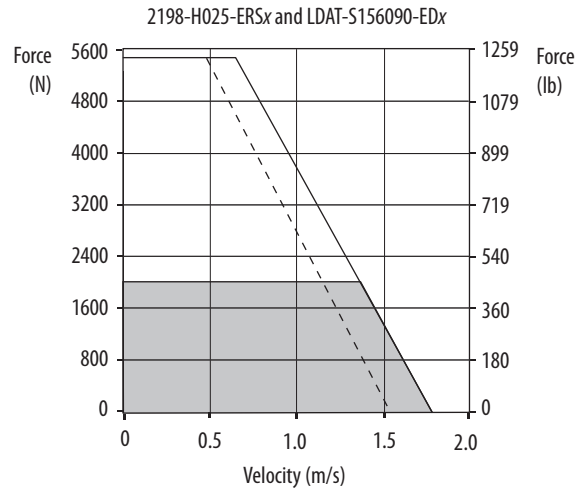
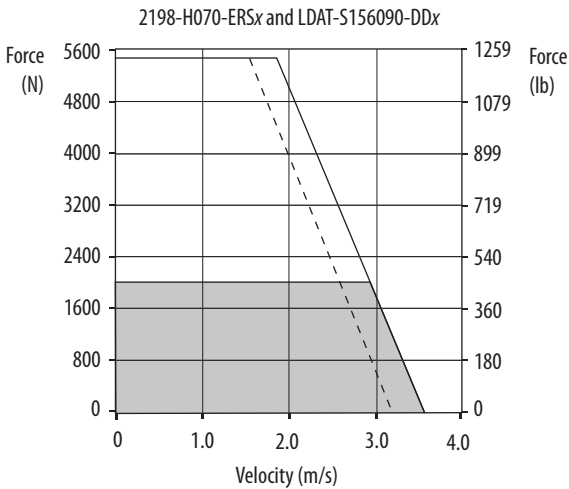
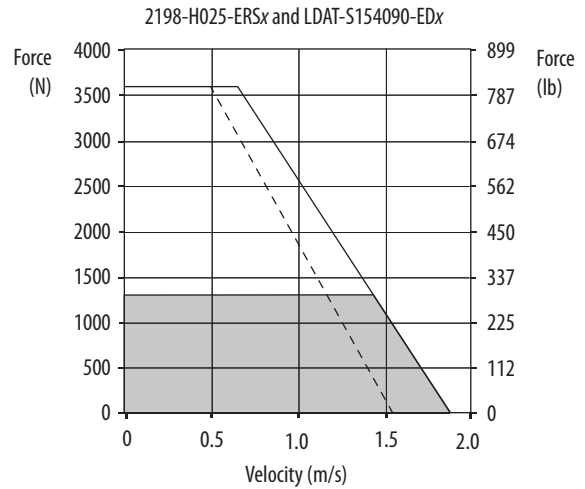
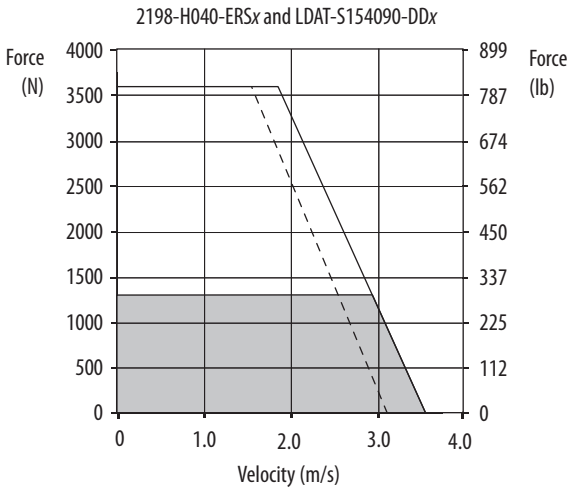
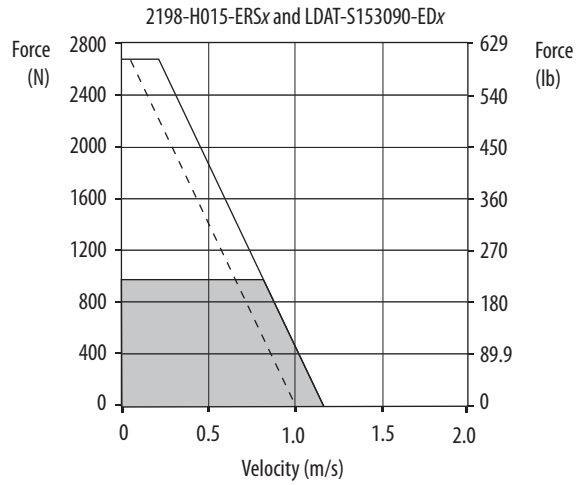
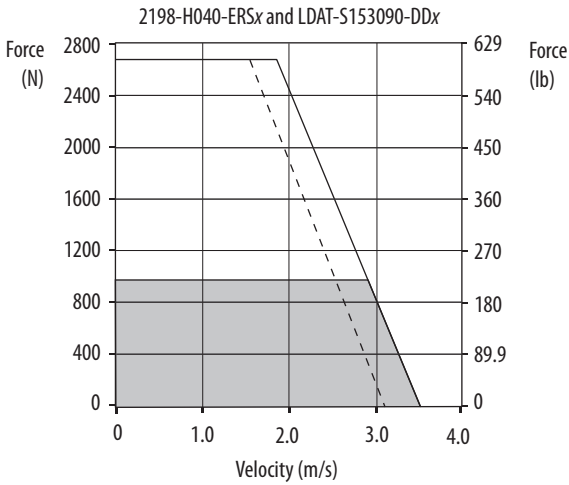

= Intermittent operating region
 = Continuous operating region
 = Drive operation with 400V AC input voltage

Kinetix 5500 (200V-class operation) Drives with MP-Series Linear Stages

This section provides system combination information for the Kinetix 5500 drives (with 240V, nominal input) when matched with MP-Series (400V-class) integrated (ballscrew) linear stages with absolute high-resolution encoders. Included are motor power/brake and feedback cable catalog numbers, system performance specifications, and the optimum force/velocity curves.

IMPORTANT The MP-Series (200V-class) linear stages require the 2198-H2DCK (series B or later) feedback converter kit.

Kinetix 5500 servo drives are capable of 200V or 400V-class operation. The 200V-class system performance tables and force/velocity curves reflect single-phase and three-phase drive operation with 240V AC input; however, only 2198-H003-ERSx, 2198-H008-ERSx, and 2198-H015-ERSx drives are capable of single-phase operation.

Bulletin MPAS Cable Combinations

Linear Stage (200V-class) Cat. No.	Motor Power/Brake Cable	Motor Feedback Cable ⁽¹⁾
MPAS-Axxxx1-V05SxA, MPAS-Axxxx2-V20SxA	2090-CPxM7DF-16AAxx (standard, non-flex) 2090-CPxM7DF-16AFxx (continuous-flex)	2090-CFBM7DF-CEAAxx (standard, non-flex) 2090-CFBM7DF-CEAFxx (continuous-flex) Absolute High-resolution Feedback

(1) Use the 2198-H2DCK (series B or later) Hipurface-to-DSL feedback converter kit with flying-lead cables on the drive end. Refer to Required Drive Accessories on [page 8](#).

For cable configuration illustrations and feature descriptions, by catalog number, refer to 2090-Series Motor Power/Brake and Feedback Cables Overview beginning on [page 14](#). Motor-end connector kits are available for motor power/brake and feedback cables. Refer to the Kinetix Motion Accessories Technical Data, publication [KNX-TD004](#), for more information. Cable length xx is in meters. Refer to the Kinetix Motion Accessories Technical Data, publication [KNX-TD004](#), for standard cable lengths.

Bulletin MPAS Performance Specifications with Kinetix 5500 (200V-class operation) Drives

Linear Stage Cat. No.	Speed, max mm/s (in/s)	System Continuous Stall Current Amps 0-pk	System Continuous Stall Force N (lb)	System Peak Stall Current Amps 0-pk	System Peak Stall Force N (lb)	Motor Output Power Rating kW	Kinetix 5500 Drives (240V AC operation)
MPAS-Axxxx1-V05SxA	200 (7.9) ⁽¹⁾	3.09	521 (117)	6.10	1212 (272)	0.37	2198-H008-ERSx
MPAS-Axxxx2-V20SxA	1124 (44.3) ⁽²⁾	4.54	462 (104)	9.10	968 (218)	0.62	2198-H015-ERSx

(1) For 900 mm stroke length, maximum speed is 176 mm/s (6.9 in/s). For 1020 mm stroke length, maximum speed is 143 mm/s (5.6 in/s).

(2) For 780 mm stroke length, maximum speed is 889 mm/s (35.0 in/s). For 900 mm stroke length, maximum speed is 715 mm/s (28.2 in/s). For 1020 mm stroke length, maximum speed is 582 mm/s (22.9 in/s).

Performance specification data and curves reflect nominal system performance of a typical system with motor at 40 °C (104 °F) and drive at 40 °C (104 °F) ambient and rated line voltage. For additional information on ambient and line conditions, refer to Motion Analyzer software.

Kinetix 5500 (200V-class operation) Drives/MP-Series Integrated Linear Stage Curves

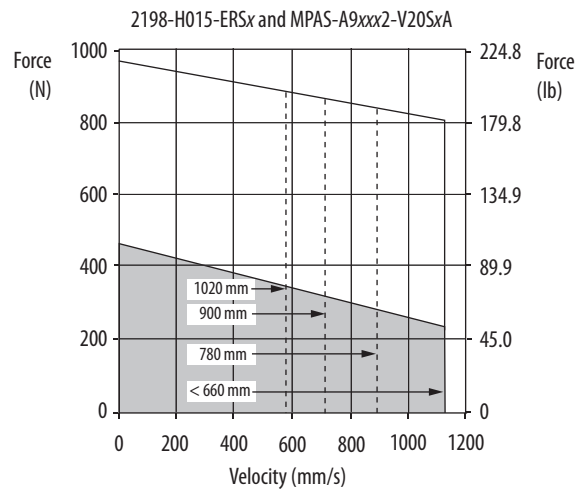
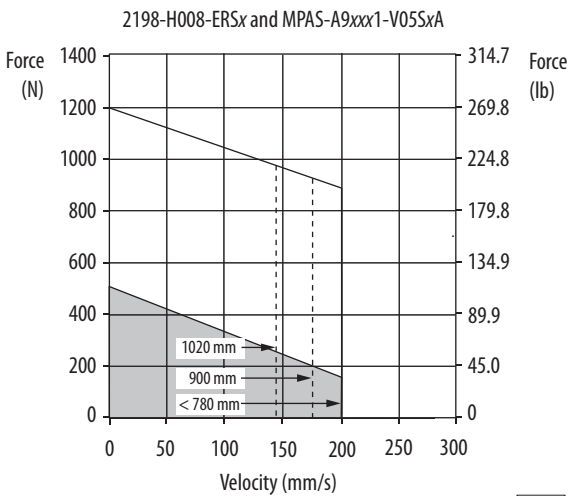
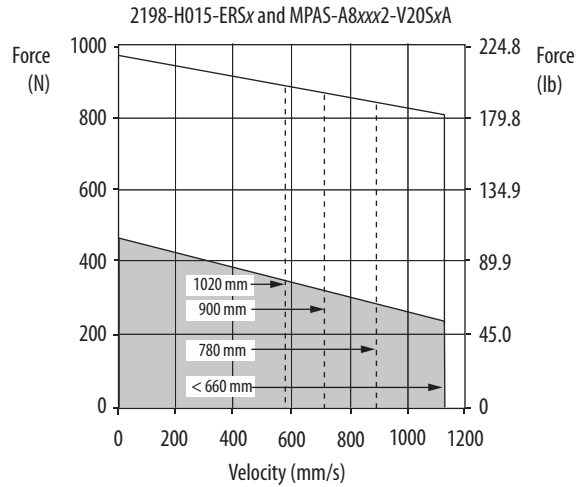
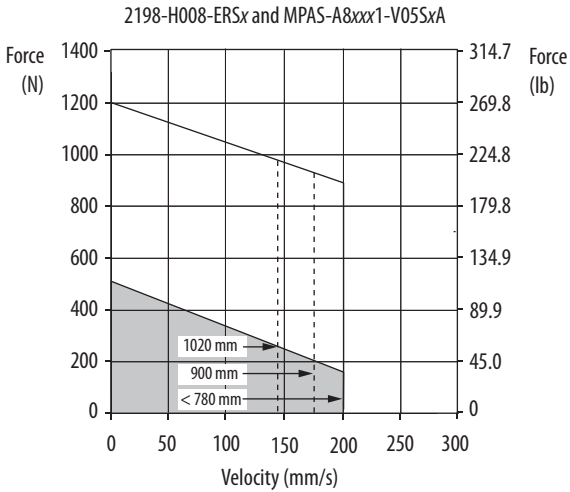
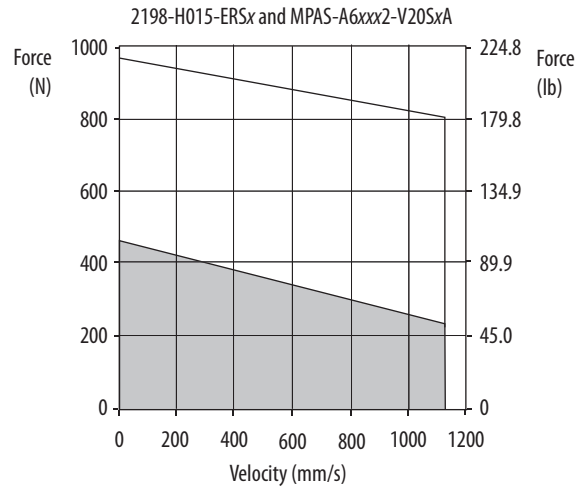
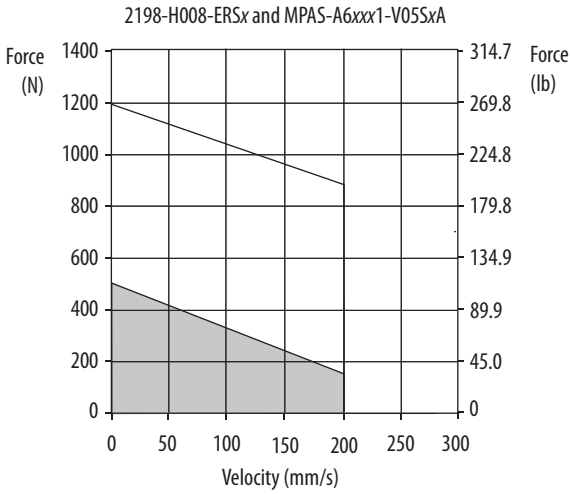

- = Intermittent operating region
- = Continuous operating region
- = System operation for specified stroke length

Kinetix 5500 (400V-class operation) Drives with MP-Series Linear Stages

This section provides system combination information for the Kinetix 5500 drives (with 480V, nominal input) when matched with MP-Series (400V-class) integrated (ballscrew) linear stages with absolute high-resolution encoders. Included are motor power/brake and feedback cable catalog numbers, system performance specifications, and the optimum force/velocity curves.

IMPORTANT The MP-Series (400V-class) linear stages require the 2198-H2DCK (series B or later) feedback converter kit.

Bulletin MPAS Cable Combinations

Linear Stage (400V-class) Cat. No.	Motor Power/Brake Cable	Motor Feedback Cable ⁽¹⁾
MPAS-Bxxxx1-V05SxA MPAS-Bxxxx2-V20SxA	2090-CPxM7DF-16AAxx (standard, non-flex) 2090-CPxM7DF-16AFxx (continuous-flex)	2090-CFBM7DF-CEAAxx (standard, non-flex) 2090-CFBM7DF-CEAFxx (continuous-flex) Absolute High-resolution Feedback

(1) Use the 2198-H2DCK (series B or later) Hipurface-to-DSL feedback converter kit with flying-lead cables on the drive end. Refer to Required Drive Accessories on [page 8](#).

For cable configuration illustrations and feature descriptions, by catalog number, refer to 2090-Series Motor Power/Brake and Feedback Cables Overview beginning on [page 14](#). Motor-end connector kits are available for motor power/brake and feedback cables. Refer to the Kinetix Motion Accessories Technical Data, publication [KNX-TD004](#), for more information. Cable length xx is in meters. Refer to the Kinetix Motion Accessories Technical Data, publication [KNX-TD004](#), for standard cable lengths.

Bulletin MPAS Performance Specifications with Kinetix 5500 (400V-class operation) Drives

Linear Stage Cat. No.	Speed, max mm/s (in/s)	System Continuous Stall Current Amps 0-pk	System Continuous Stall Force N (lb)	System Peak Stall Current Amps 0-pk	System Peak Stall Force N (lb)	Motor Output Power Rating kW	Kinetix 5500 Drives (480V AC operation)
MPAS-Bxxxx1-V05SxA	200 (7.9) ⁽¹⁾	1.75	521 (117)	3.50	1212 (272)	0.37	2198-H008-ERSx
MPAS-Bxxxx2-V20SxA	1124 (44.3) ⁽²⁾	3.30	462 (104)	6.60	968 (218)	0.62	2198-H008-ERSx

(1) For 900 mm stroke length, maximum speed is 176 mm/s (6.9 in/s). For 1020 mm stroke length, maximum speed is 143 mm/s (5.6 in/s).

(2) For 780 mm stroke length, maximum speed is 889 mm/s (35.0 in/s). For 900 mm stroke length, maximum speed is 715 mm/s (28.2 in/s). For 1020 mm stroke length, maximum speed is 582 mm/s (22.9 in/s).

Performance specification data and curves reflect nominal system performance of a typical system with motor at 40 °C (104 °F) and drive at 40 °C (104 °F) ambient and rated line voltage. For additional information on ambient and line conditions, refer to Motion Analyzer software.

Kinetix 5500 (400V-class operation) Drives/MP-Series Linear Stage Curves

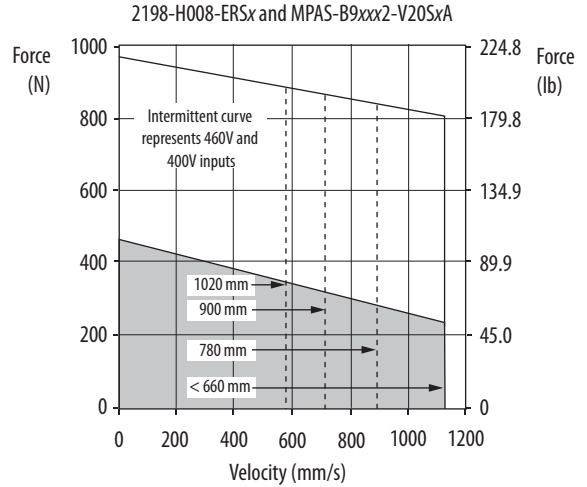
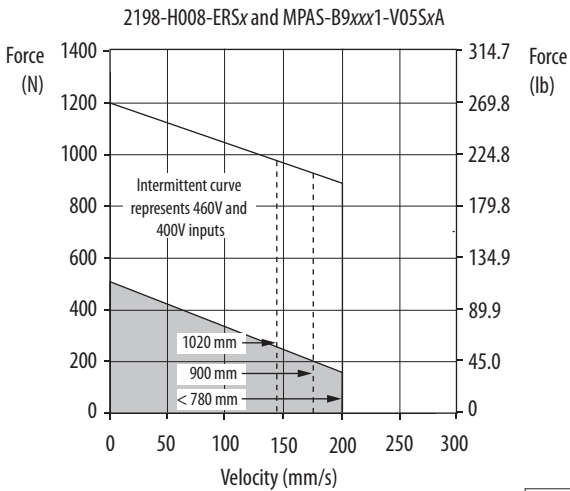
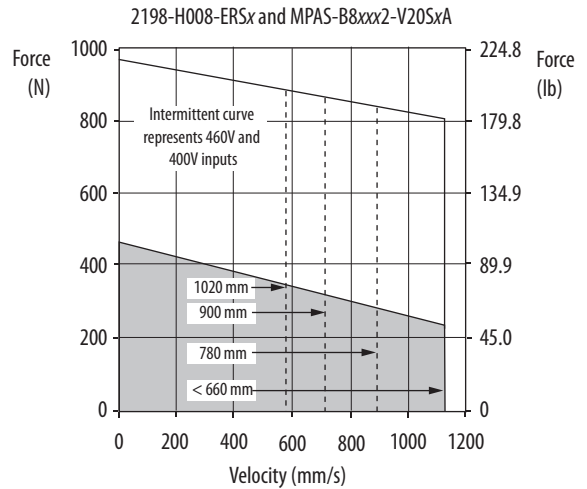
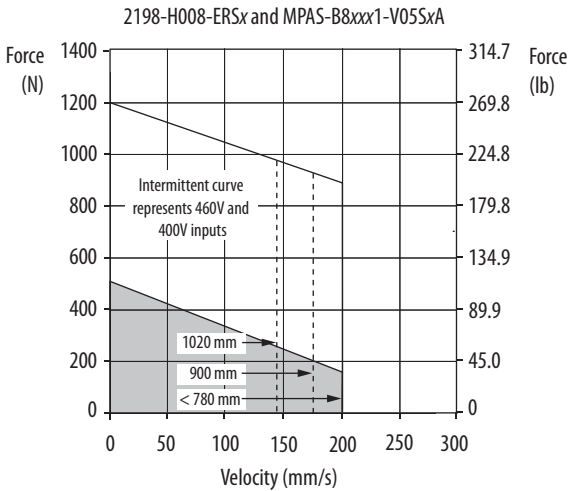
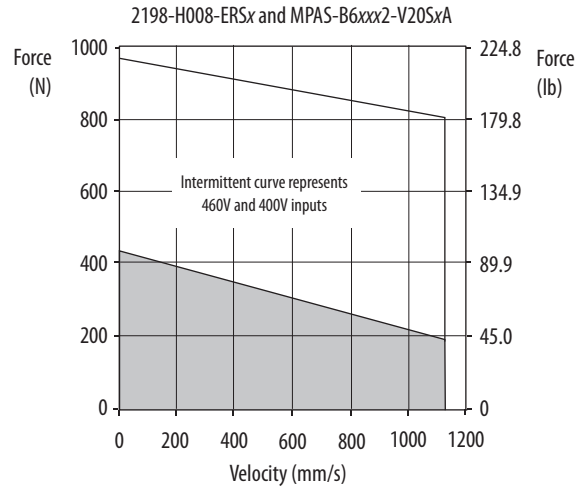
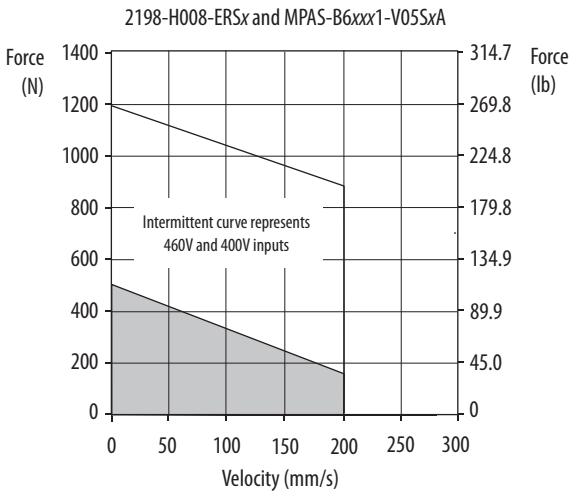

- = Intermittent operating region
- = Continuous operating region
- = System operation with 400V AC rms input voltage
- = System operation for specified stroke length

Kinetix 5500 Drives with Kinetix VP Electric Cylinders

This section provides system combination information for the Kinetix 5500 drives (with 240V and 480V, nominal input) when matched with Kinetix VP electric cylinders. Included are motor power/brake and feedback cable catalog numbers, system performance specifications, and the optimum force/velocity curves.

Bulletin VPAR Cable Combinations

Kinetix VP Electric Cylinders (200V-class)

Electric Cylinder Cat. No.	Single Motor Cable ⁽¹⁾	Feedback Type
VPAR-A1xxxB VPAR-A1xxxE VPAR-A2xxxC	2090-CSBM1Dx-18AAxx or 2090-CSWM1Dx-18AAxx (standard, non-flex) 2090-CSBM1Dx-18AFxx (continuous-flex)	Absolute, Multi-turn Digital Encoder, (Hiperface DSL Protocol)
VPAR-A2xxxF VPAR-A3xxxE VPAR-A3xxxH	2090-CSBM1Dx-14AAxx or 2090-CSWM1Dx-14AAxx (standard, non-flex) 2090-CSBM1Dx-14AFxx (continuous-flex)	

(1) Use 2090-CSxM1DF or 2090-CSxM1DG cables. Cable length xx is in meters, 01 (3.3) . . . 50 (164) in 1.0 m (3.3 ft) increments. Refer to the Kinetix Motion Accessories Technical Data, publication [KNX-TD004](#), for cable specifications. For cable configuration illustrations and feature descriptions, by catalog number, refer to 2090-Series Single Motor Cable Overview beginning on [page 13](#).

Kinetix VP Electric Cylinders (400V-class)

Electric Cylinder Cat. No.	Single Motor Cable ⁽¹⁾	Feedback Type
VPAR-B1xxxB VPAR-B1xxxE VPAR-B2xxxC VPAR-B2xxxF	2090-CSBM1Dx-18AAxx or 2090-CSWM1Dx-18AAxx (standard, non-flex) 2090-CSBM1Dx-18AFxx (continuous-flex)	Absolute, Multi-turn Digital Encoder, SIL 2/PLd Rated, (Hiperface DSL Protocol)
VPAR-B3xxxE VPAR-B3xxxH	2090-CSBM1Dx-14AAxx or 2090-CSWM1Dx-14AAxx (standard, non-flex) 2090-CSBM1Dx-14AFxx (continuous-flex)	

(1) Use 2090-CSxM1DF or 2090-CSxM1DG cables. Cable length xx is in meters, 01 (3.3) . . . 50 (164) in 1.0 m (3.3 ft) increments. Refer to the Kinetix Motion Accessories Technical Data, publication [KNX-TD004](#), for cable specifications. For cable configuration illustrations and feature descriptions, by catalog number, refer to 2090-Series Single Motor Cable Overview beginning on [page 13](#).

Bulletin VPAR Performance Specifications with Kinetix 5500 Drives

Performance Specifications with Kinetix 5500 (200V-class operation) Drives

Electric Cylinder Cat. No.	Speed, max mm/s (in/s)	System Continuous Stall Current Amps 0-pk	System Continuous Stall Force N (lb)	System Peak Stall Current Amps 0-pk	System Peak Stall Force N (lb)	Motor Output Power Rating kW	Kinetix 5500 Drives (240V AC input)
VPAR-A1xxxB	150	0.88	240 (53.9)	2.90	300 (67.4)	0.11	2198-H008-ERSx
VPAR-A1xxxE	500	1.66	280 (62.9)	2.90	350 (78.7)	0.23	2198-H008-ERSx
VPAR-A2xxxC	250	1.74	420 (94.4)	3.72	525 (118)	0.25	2198-H008-ERSx
VPAR-A2xxxF	640	4.45	640 (144)	8.40	800 (180)	0.56	2198-H015-ERSx
VPAR-A3xxxE	500	12.30	2000 (450)	31.70	2500 (562)	1.30	2198-H040-ERSx
VPAR-A3xxxH	1000	13.50	1284 (289)	27.00	1625 (365)	1.56	2198-H040-ERSx

Performance Specifications with Kinetix 5500 (400V-class operation) Drives

Electric Cylinder Cat. No.	Speed, max mm/s (in/s)	System Continuous Stall Current Amps 0-pk	System Continuous Stall Force N (lb)	System Peak Stall Current Amps 0-pk	System Peak Stall Force N (lb)	Motor Output Power Rating kW	Kinetix 5500 Drives (480V AC input)
VPAR-B1xxxB	150	0.41	240 (53.9)	1.34	300 (67.4)	0.11	2198-H003-ERSx
VPAR-B1xxxE	500	1.20	280 (62.9)	2.10	350 (78.7)	0.24	2198-H003-ERSx
VPAR-B2xxxC	250	1.25	420 (94.4)	2.67	525 (118)	0.25	2198-H003-ERSx
VPAR-B2xxxF	640	3.10	640 (144)	5.80	800 (180)	0.56	2198-H008-ERSx
VPAR-B3xxxE	500	5.10	2000 (450)	13.0	2500 (562)	1.30	2198-H015-ERSx
VPAR-B3xxxH	1000	8.60	1284 (289)	17.0	1625 (365)	1.68	2198-H015-ERSx

Performance specification data and curves reflect nominal system performance of a typical system with the motor at 40 °C (104 °F) and the drive at 50 °C (122 °F) ambient, and rated line voltage. For additional information on ambient and line conditions, refer to Motion Analyzer software.

Kinetix 5500 Drives/Kinetix VP Electric Cylinder Curves

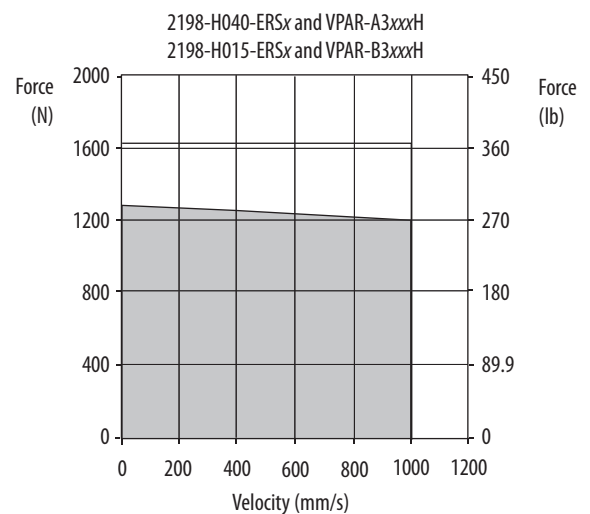
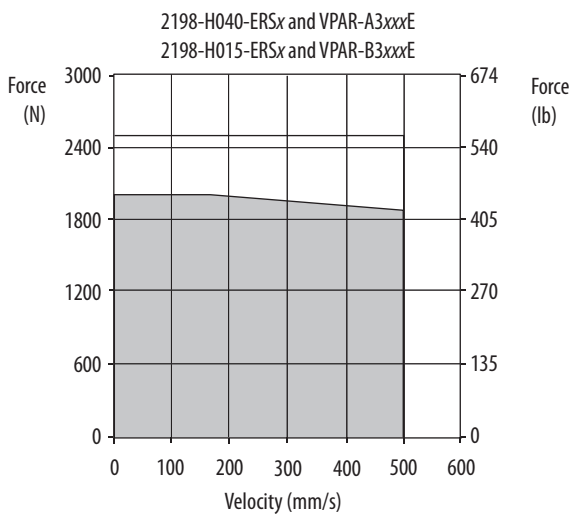
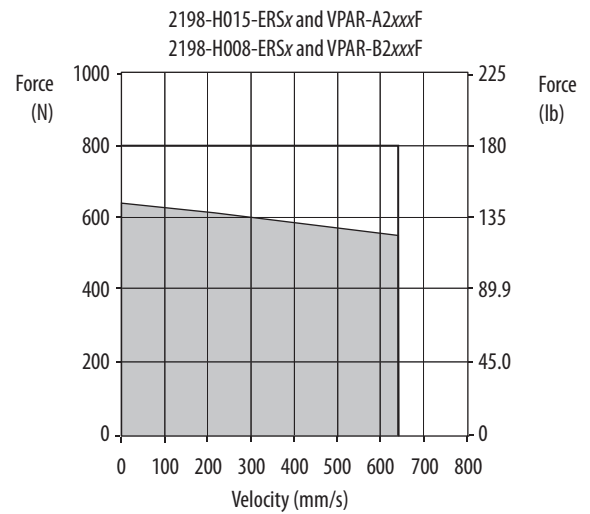
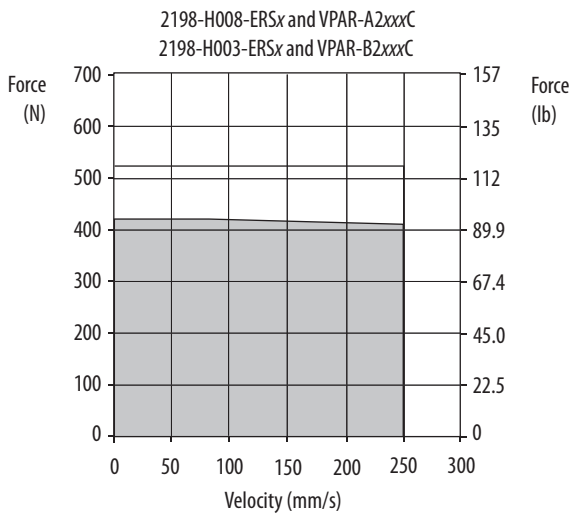
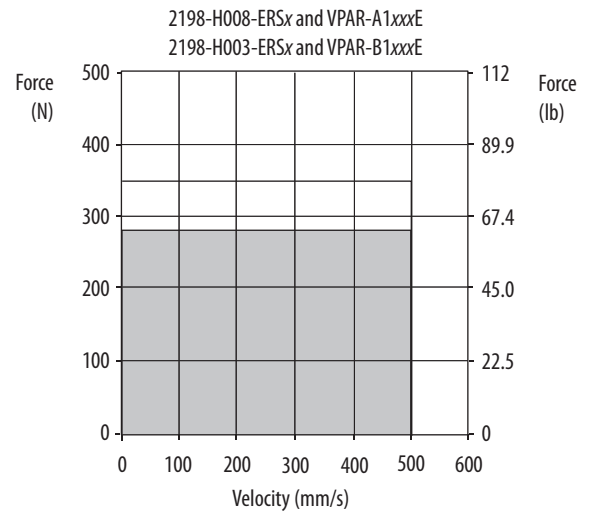
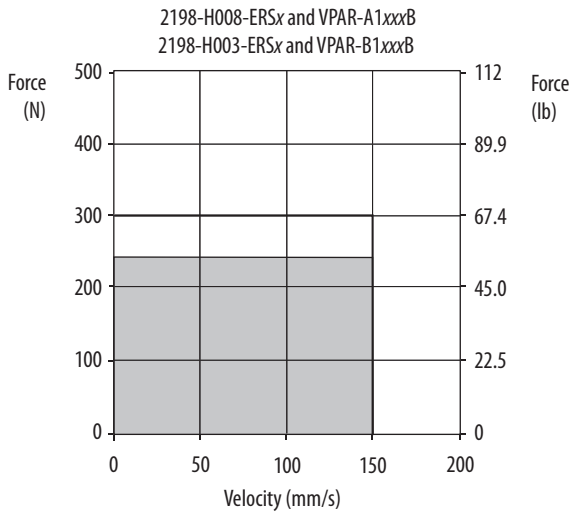

= Intermittent operating region
 = Continuous operating region

Kinetix 5500 Drives with MP-Series Electric Cylinders

This section provides system combination information for the Kinetix 5500 drives (with 240V and 480V, nominal input) when matched with MP-Series electric cylinders. Included are motor power/brake and feedback cable catalog numbers, system performance specifications, and the optimum force/velocity curves.

IMPORTANT The MP-Series electric cylinders require the 2198-H2DCK (series B or later) feedback converter kit.

Kinetix 5500 servo drives are capable of 200V or 400V-class operation. The 200V-class system performance tables and force/velocity curves reflect single-phase and three-phase drive operation with 240V AC input; however, only 2198-H003-ERSx, 2198-H008-ERSx, and 2198-H015-ERSx drives are capable of single-phase operation.

Bulletin MPAR Cable Combinations

Electric Cylinder (200V and 400V-class) Cat. No.	Motor Power/Brake Cable	Motor Feedback Cable ⁽¹⁾
MPAR-A1xxxB, MPAR-A1xxxE MPAR-A2xxxC, MPAR-A2xxxF MPAR-A3xxxE, MPAR-A3xxxH	2090-CPxM7DF-16AAxx (standard, non-flex) 2090-CPxM7DF-16AFxx (continuous-flex)	2090-CFBM7DF-CEAAxx (standard, non-flex) 2090-CFBM7DF-CEAFxx (continuous-flex) Absolute High-resolution Feedback
MPAR-B1xxxB, MPAR-B1xxxE MPAR-B2xxxC, MPAR-B2xxxF MPAR-B3xxxE, MPAR-B3xxxH		

(1) Use the 2198-H2DCK (series B or later) Hiperface-to-DSL feedback converter kit with flying-lead cables on the drive end. Refer to Required Drive Accessories on [page 8](#).

For cable configuration illustrations and feature descriptions, by catalog number, refer to 2090-Series Motor Power/Brake and Feedback Cables Overview beginning on [page 14](#). Motor-end connector kits are available for motor power/brake and feedback cables. Refer to the Kinetix Motion Accessories Technical Data, publication [KNX-TD004](#), for more information. Cable length xx is in meters. Refer to the Kinetix Motion Accessories Technical Data, publication [KNX-TD004](#), for standard cable lengths.

Bulletin MPAR Performance Specifications with Kinetix 5500 Drives

Performance Specifications with Kinetix 5500 (200V-class operation) Drives

Electric Cylinder Cat. No.	Speed, max mm/s (in/s)	System Continuous Stall Current Amps 0-pk	System Continuous Stall Force N (lb)	System Peak Stall Current Amps 0-pk	System Peak Stall Force N (lb)	Motor Output Power Rating kW	Kinetix 5500 Drives (240V AC input)
MPAR-A1xxxB	150	1.15	240 (53.9)	1.35	300 (67.4)	0.036	2198-H003-ERSx
MPAR-A1xxxE	500	2.16	280 (62.9)	2.48	350 (78.7)	0.140	2198-H008-ERSx
MPAR-A2xxxC	250	2.42	420 (94.4)	2.72	525 (118)	0.105	2198-H008-ERSx
MPAR-A2xxxF	640	4.54	640 (144)	5.41	800 (180)	0.410	2198-H015-ERSx
MPAR-A3xxxE	500	10.33	2000 (450)	12.34	2500 (562)	1.00	2198-H025-ERSx
MPAR-A3xxxH	1000	12.20	1300 (292)	16.40	1625 (365)	1.30	2198-H040-ERSx

Performance Specifications with Kinetix 5500 (400V-class operation) Drives

Electric Cylinder Cat. No.	Speed, max mm/s (in/s)	System Continuous Stall Current Amps 0-pk	System Continuous Stall Force N (lb)	System Peak Stall Current Amps 0-pk	System Peak Stall Force N (lb)	Motor Output Power Rating kW	Kinetix 5500 Drives (480V AC input)
MPAR-B1xxxB	150	1.15	240 (53.9)	1.35	300 (67.4)	0.036	2198-H003-ERSx
MPAR-B1xxxE	500	1.49	280 (62.9)	1.71	350 (78.7)	0.140	2198-H003-ERSx
MPAR-B2xxxC	250	1.67	420 (94.4)	1.90	525 (118)	0.105	2198-H003-ERSx
MPAR-B2xxxF	640	3.29	640 (144)	3.93	800 (180)	0.410	2198-H008-ERSx
MPAR-B3xxxE	500	5.16	2000 (450)	6.17	2500 (562)	1.00	2198-H015-ERSx
MPAR-B3xxxH	1000	6.13	1300 (292)	6.79	1625 (365)	1.30	2198-H015-ERSx

Performance specification data and curves reflect nominal system performance of a typical system with motor at 40 °C (104 °F) and drive at 40 °C (104 °F) ambient and rated line voltage. For additional information on ambient and line conditions, refer to Motion Analyzer software.

Kinetix 5500 Drives/MP-Series Electric Cylinder Curves

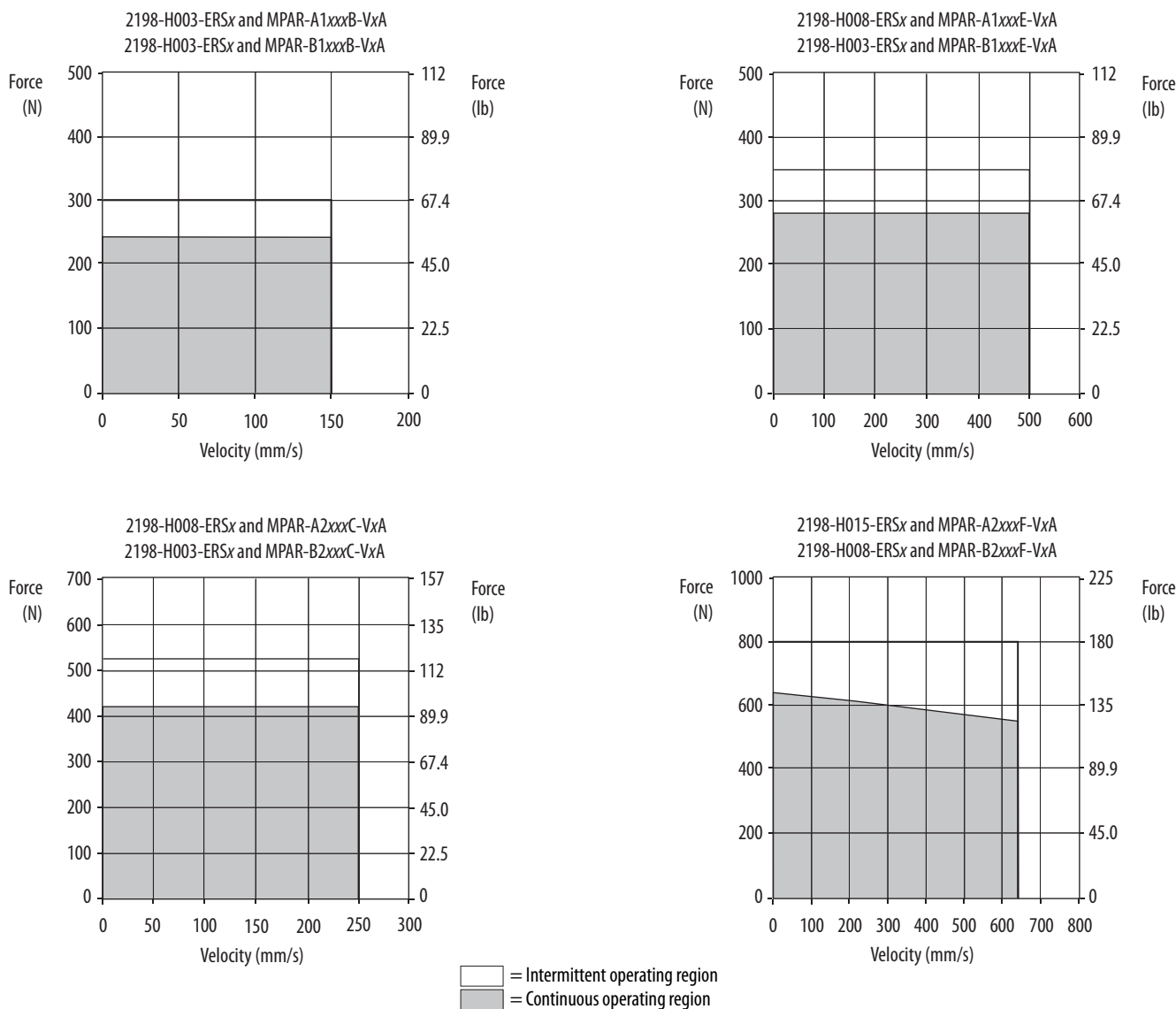

Kinetix 5500 Drives/MP-Series Electric Cylinder Curves (continued)

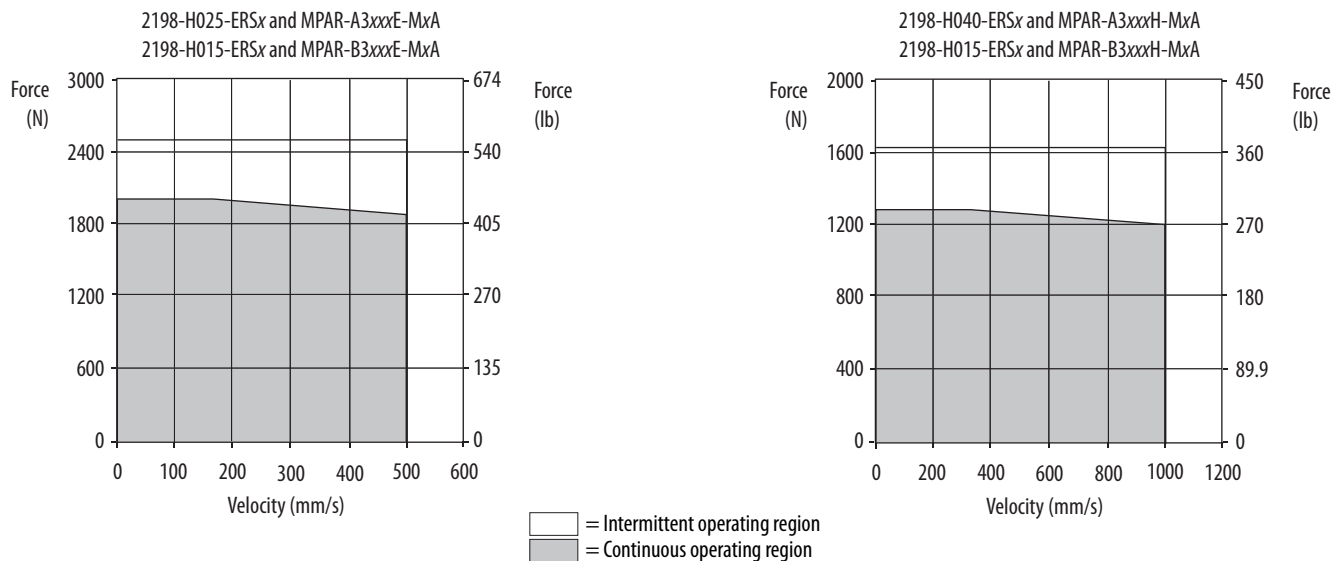

Kinetix 5500 Drives with MP-Series Heavy Duty Electric Cylinders

This section provides system combination information for the Kinetix 5500 drives (with 240V and 480V, nominal input) when matched with MP-Series heavy-duty electric cylinders. Included are motor power/brake and feedback cable catalog numbers, system performance specifications, and the optimum force/velocity curves.

IMPORTANT The MP-Series heavy duty electric cylinders require the 2198-H2DCK (series B or later) feedback converter kit.

Kinetix 5500 servo drives are capable of 200V or 400V-class operation. The 200V-class system performance tables and force/velocity curves reflect single-phase and three-phase drive operation with 240V AC input; however, only 2198-H003-ERSx, 2198-H008-ERSx, and 2198-H015-ERSx drives are capable of single-phase operation.

Bulletin MPAI Cable Combinations

Electric Cylinder (200V and 400V-class) Cat. No.	Motor Power/Brake Cable	Motor Feedback Cable ⁽¹⁾
MPAI-A/B2xxxC	2090-CPxM7DF-16AAxx (standard, non-flex) 2090-CPxM7DF-16AFxx (continuous-flex)	2090-CFBM7DF-CEAAxx (standard, non-flex) 2090-CFBM7DF-CEAFxx (continuous-flex) Absolute High-resolution Feedback
MPAI-A/B3xxxC, MPAI-A/B3xxxE MPAI-A/B3xxxR, MPAI-A/B3xxxS		
MPAI-A/B4xxxC, MPAI-A/B4xxxE MPAI-A/B4xxxR, MPAI-A/B4xxxS		
MPAI-B5xxxC, MPAI-B5xxxE	2090-CPxM7DF-14AAxx (standard, non-flex) 2090-CPxM7DF-14AFxx (continuous-flex)	
MPAI-A5xxxC, MPAI-A5xxxE		

(1) Use the 2198-H2DCK (series B or later) Hiperface-to-DSL feedback converter kit with flying-lead cables on the drive end. Refer to Required Drive Accessories on [page 8](#).

For cable configuration illustrations and feature descriptions, by catalog number, refer to 2090-Series Motor Power/Brake and Feedback Cables Overview beginning on [page 14](#). Motor-end connector kits are available for motor power/brake and feedback cables. Refer to the Kinetix Motion Accessories Technical Data, publication [KNX-TD004](#), for more information. Cable length xx is in meters. Refer to the Kinetix Motion Accessories Technical Data, publication [KNX-TD004](#), for standard cable lengths.

Bulletin MPAI Performance Specifications with Kinetix 5500 (200V-class operation) Drives

Performance Specifications with Ball Screw Electric Cylinders

Electric Cylinder Cat. No.	Speed, max mm/s (in/s)	System Continuous Stall Current Amps 0-pk	System Continuous Stall Force N (lb)		System Peak Stall Current Amps 0-pk	System Peak Stall Force N (lb)	Motor Output Power Rating kW	Kinetix 5500 Drives (240V AC input)
			25 °C (77 °F)	40 °C (104 °F)				
MPAI-A2076CV1	305 (12)	1.80	890 (200)	706 (159)	4.50	1446 (325)	0.22	2198-H008-ERSx
MPAI-A2150CV3		2.47	1446 (325)	1147 (258)	6.20		0.25	
MPAI-A2300CV3								
MPAI-A3076CM1	305 (12)	2.68	1624 (365)	1290 (290)	8.90	4448 (1000)	0.27	2198-H008-ERSx
MPAI-A3076EM1	610 (24)		814 (183)	645 (145)		2570 (578)		
MPAI-A3150CM3	279 (11)	5.61	4003 (900)	3176 (714)	8.40	4448 (1000)	0.39	2198-H015-ERSx
MPAI-A3300CM3	188 (7.3)							
MPAI-A3450CM3	188 (7.3)							
MPAI-A3150EM3	559 (22)		2002 (450)	1588 (357)	14.14	4003 (900)		
MPAI-A3300EM3	559 (22)							
MPAI-A3450EM3	376 (15)							
MPAI-A4150CM3	279 (11)							
MPAI-A4300CM3	279 (11)	10.89	7784 (1750)	6179 (1389)	17.07	8896 (2000)	0.43	2198-H025-ERSx
MPAI-A4450CM3	245 (9.5)							
MPAI-A4150EM3	559 (22)		3892 (875)	3092 (695)	27.44	7784 (1750)		
MPAI-A4300EM3	559 (22)							
MPAI-A4450EM3	491 (19)							
MPAI-A5xxxCM3	200 (7.8)							
MPAI-A5xxxEM3	400 (15.6)	13.25	13,123 (2950)	10,415 (2341)	16.70	13,345 (3000)	0.55	2198-H040-ERSx
MPAI-A5xxxEM3	400 (15.6)		6562 (1475)	5208 (1171)	33.40	13,122 (2950)		

Performance Specifications with Roller Screw Electric Cylinders

Electric Cylinder Cat. No.	Speed, max mm/s (in/s)	System Continuous Stall Current Amps 0-pk	System Continuous Stall Force N (lb)		System Peak Stall Current Amps 0-pk	System Peak Stall Force N (lb)	Motor Output Power Rating kW	Kinetix 5500 Drives (240V AC input)
			25 °C (77 °F)	40 °C (104 °F)				
MPAI-A3076RM1	305 (12)	2.87	1557 (350)	1237 (278)	8.90	4862 (1093)	0.27	2198-H008-ERSx
MPAI-A3076SM1	610 (24)		778 (175)	618 (139)		2431 (547)		
MPAI-A3150RM3	279 (11)	5.61	3781 (850)	3003 (675)	14.14	7562 (1700)	0.39	2198-H015-ERSx
MPAI-A3300RM3	176 (6.9)							
MPAI-A3450RM3	176 (6.9)							
MPAI-A3150SM3	559 (22)		1891 (425)	1499 (337)	27.44	3781 (850)		
MPAI-A3300SM3	559 (22)							
MPAI-A3450SM3	353 (14)							
MPAI-A4150RM3	279 (11)							
MPAI-A4300RM3	279 (11)	10.89	7340 (1650)	5827 (1310)	27.44	14,679 (3300)	0.43	2198-H025-ERSx
MPAI-A4450RM3	196 (7.6)							
MPAI-A4150SM3	559 (22)		3670 (825)	2914 (655)	27.44	7340 (1650)		
MPAI-A4300SM3	559 (22)							
MPAI-A4450SM3	393 (15)							
MPAI-A4450SM3	393 (15)							

Performance specification data and curves reflect nominal system performance of a typical system with motor at 40 °C (104 °F) and drive at 40 °C (104 °F) ambient and rated line voltage. For additional information on ambient and line conditions, refer to Motion Analyzer software.

Bulletin MPAI Performance Specifications with Kinetix 5500 (400V-class operation) Drives

Performance Specifications with Ball Screw Electric Cylinders

Electric Cylinder Cat. No.	Speed, max mm/s (in/s)	System Continuous Stall Current Amps 0-pk	System Continuous Stall Force N (lb)		System Peak Stall Current Amps 0-pk	System Peak Stall Force N (lb)	Motor Output Power Rating kW	Kinetix 5500 Drives (480V AC input)	
			25 °C (77 °F)	40 °C (104 °F)					
MPAI-B2076CV1	305 (12)	0.90	890 (200)	706 (159)	2.30	1446 (325)	0.22	2198-H003-ERSx	
MPAI-B2150CV3		1.29	1446 (325)	1147 (258)	3.25		0.25		
MPAI-B2300CV3									
MPAI-B3076CM1	305 (12)	1.35	1624 (365)	1290 (290)	4.57	4448 (1000)	0.27	2198-H008-ERSx	
MPAI-B3076EM1	610 (24)		814 (183)	645 (145)		2570 (578)			
MPAI-B3150CM3	279 (11)	2.81	4003 (900)	3176 (714)	4.30	4448 (1000)	0.39	2198-H008-ERSx	
MPAI-B3300CM3									
MPAI-B3450CM3	188 (7.3)								
MPAI-B3150EM3	559 (22)		2002 (450)	1588 (357)	7.07	4003 (900)			2198-H008-ERSx
MPAI-B3300EM3									
MPAI-B3450EM3	376 (15)								
MPAI-B4150CM3	279 (11)	5.61	7784 (1750)	6179 (1389)	8.68	8896 (2000)	0.43	2198-H015-ERSx	
MPAI-B4300CM3									
MPAI-B4450CM3	245 (9.5)		3892 (875)	3092 (695)	14.14	7784 (1750)		2198-H015-ERSx	
MPAI-B4150EM3	559 (22)								
MPAI-B4300EM3									
MPAI-B4450EM3	491 (19)								
MPAI-B5xxxCM3	200 (7.8)	6.62	13,123 (2950)	10,415 (2341)	8.48	13,345 (3000)	0.55	2198-H015-ERSx	
MPAI-B5xxxEM3	400 (15.6)		6562 (1475)	5208 (1171)	16.70	13,122 (2950)			

Performance Specifications with Roller Screw Electric Cylinders

Electric Cylinder Cat. No.	Speed, max mm/s (in/s)	System Continuous Stall Current Amps 0-pk	System Continuous Stall Force N (lb)		System Peak Stall Current Amps 0-pk	System Peak Stall Force N (lb)	Motor Output Power Rating kW	Kinetix 5500 Drives (480V AC input)
			25 °C (77 °F)	40 °C (104 °F)				
MPAI-B3076RM1	305 (12)	1.45	1557 (350)	1237 (278)	4.57	4862 (1093)	0.27	2198-H008-ERSx
MPAI-B3076SM1	610 (24)		778 (175)	618 (139)		2431 (547)		
MPAI-B3150RM3	279 (11)	2.81	3781 (850)	3003 (675)	7.07	7562 (1700)	0.39	2198-H008-ERSx
MPAI-B3300RM3								
MPAI-B3450RM3	176 (6.9)							
MPAI-B3150SM3	559 (22)		1891 (425)	1499 (337)	3781 (850)	2198-H015-ERSx		
MPAI-B3300SM3								
MPAI-B3450SM3	353 (14)							
MPAI-B4150RM3	279 (11)	5.61	7340 (1650)	5827 (1310)	14.14	14,679 (3300)	0.43	2198-H015-ERSx
MPAI-B4300RM3								
MPAI-B4450RM3	196 (7.6)		3670 (825)	2914 (655)	7340 (1650)	2198-H015-ERSx		
MPAI-B4150SM3	559 (22)							
MPAI-B4300SM3								
MPAI-B4450SM3	393 (15)							

Performance specification data and curves reflect nominal system performance of a typical system with motor at 40 °C (104 °F) and drive at 40 °C (104 °F) ambient and rated line voltage. For additional information on ambient and line conditions, refer to Motion Analyzer software.

Kinetix 5500 Drives/MP-Series (ball screw) Electric Cylinder Curves

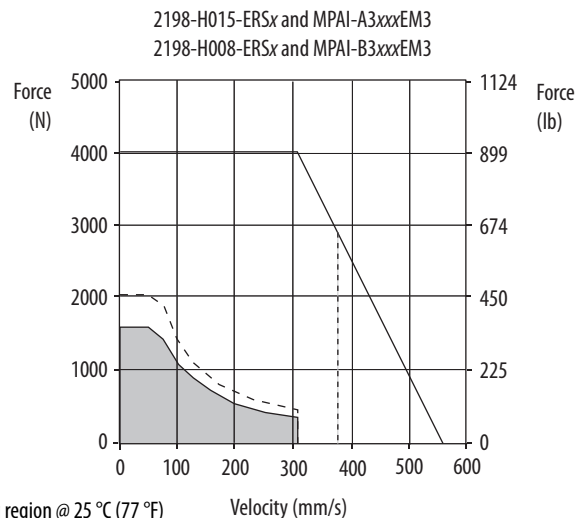
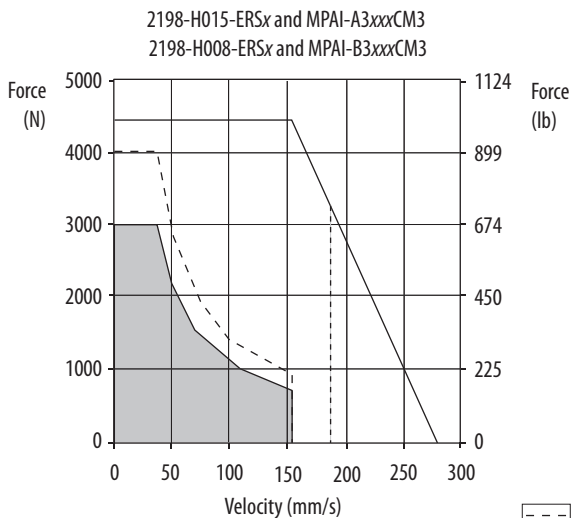
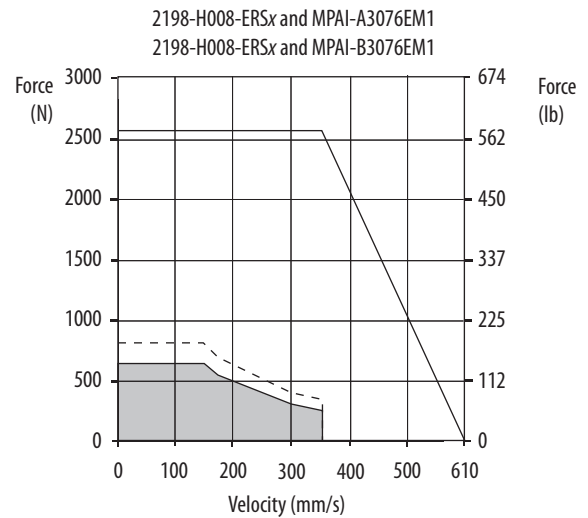
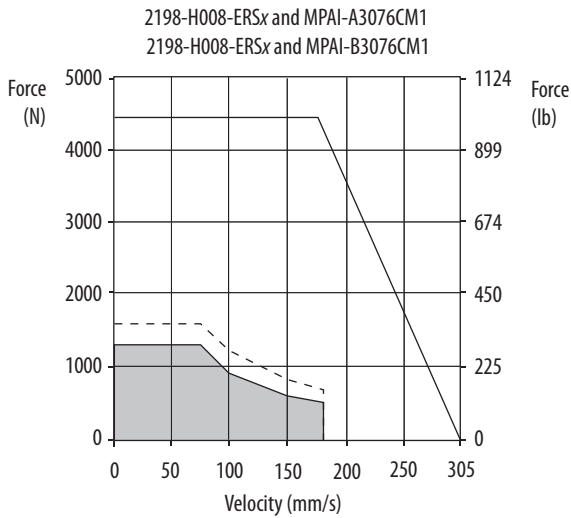
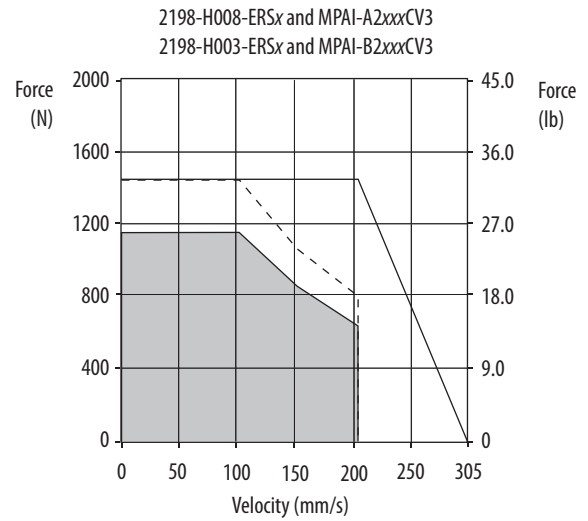
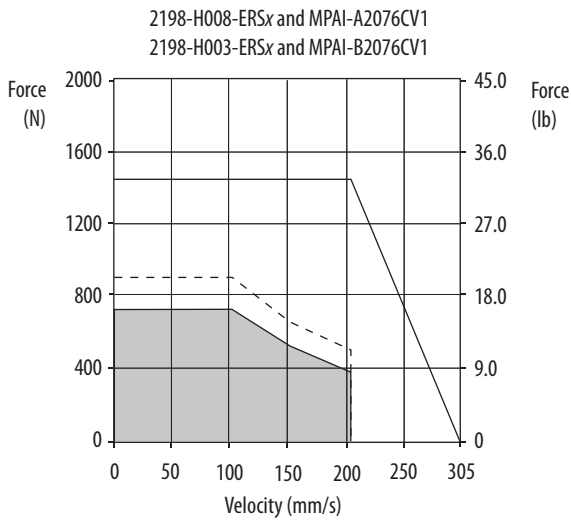

- = Continuous operating region @ 25 °C (77 °F)
- = Continuous operating region @ 40 °C (104 °F)
- - - = Intermittent operating region, 450 mm (18 in.) stroke length only
- = Intermittent operating region, 076...300 mm (3...12 in.) stroke lengths

Kinetix 5500 Drives/MP-Series (ball screw) Electric Cylinder Curves (continued)

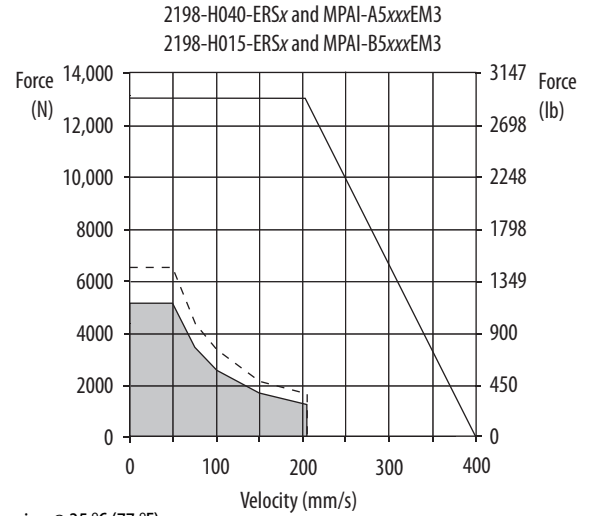
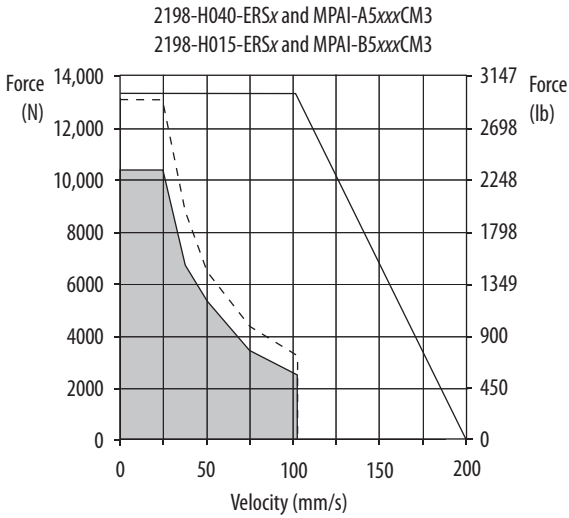
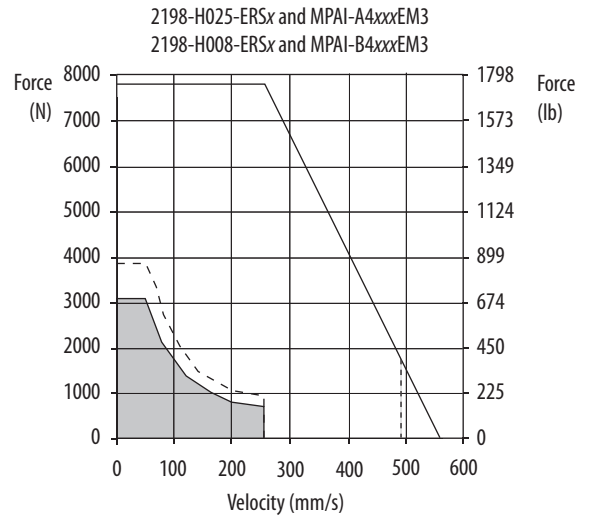
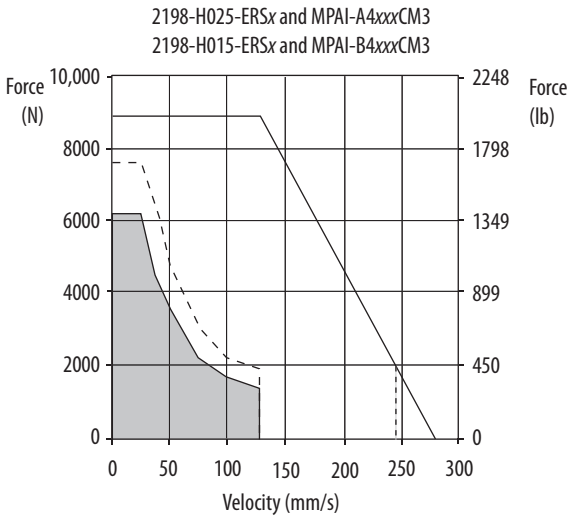

- = Continuous operating region @ 25 °C (77 °F)
- = Continuous operating region @ 40 °C (104 °F)
- = Intermittent operating region, 450 mm (18 in.) stroke length only
- = Intermittent operating region, 076...300 mm (3...12 in.) stroke lengths

Kinetix 5500 Drives/MP-Series (roller screw) Electric Cylinder Curves

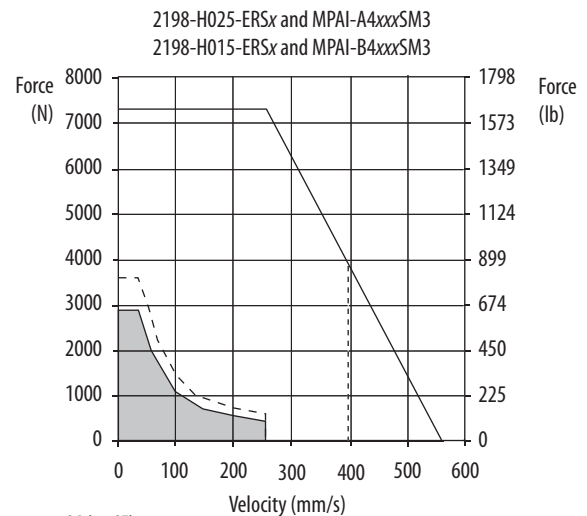
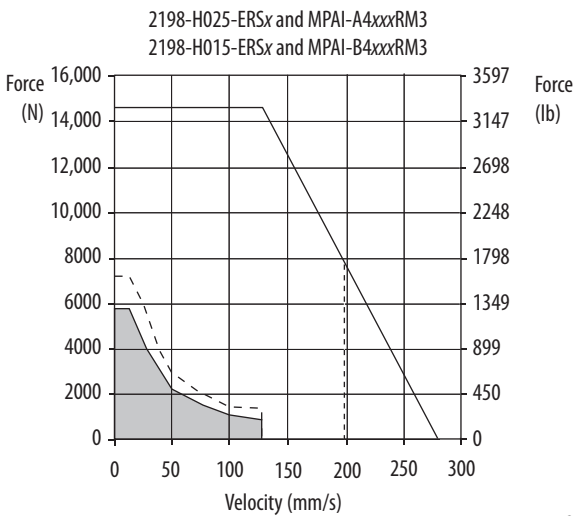
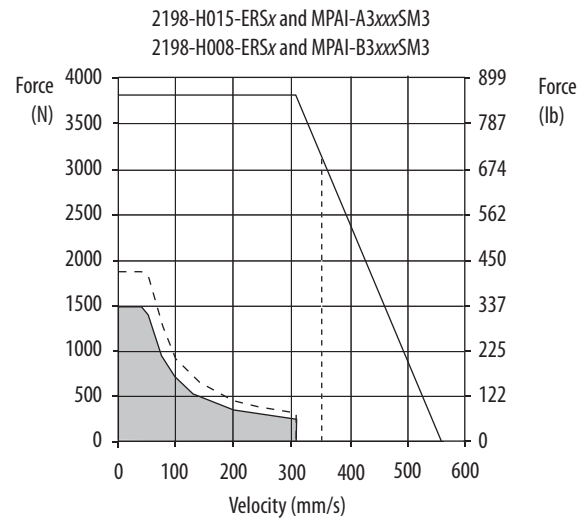
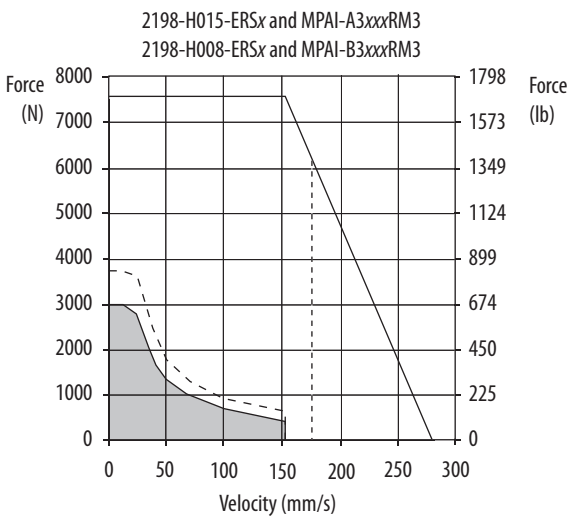
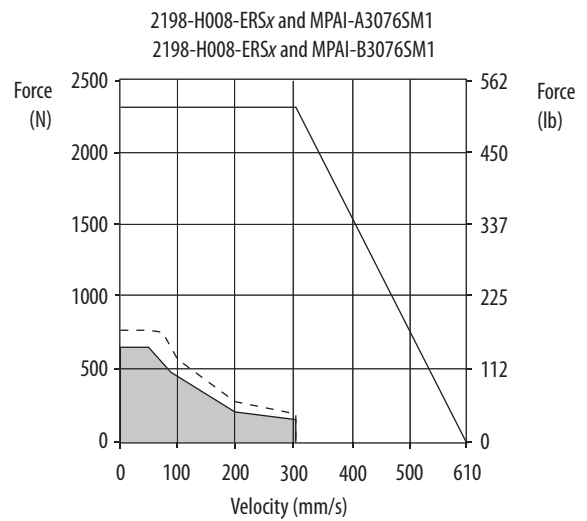
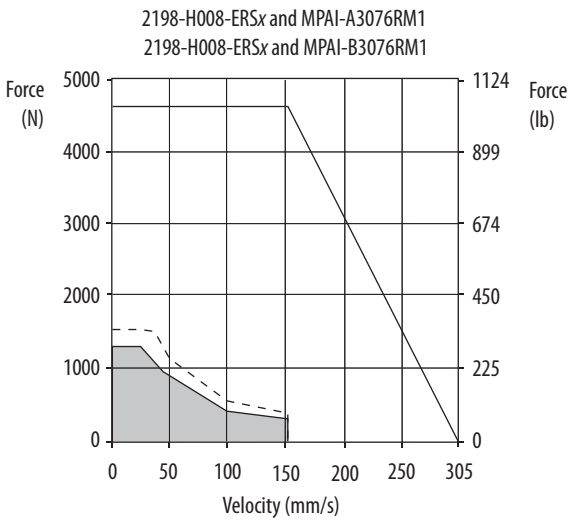

- = Continuous operating region @ 25 °C (77 °F)
- = Continuous operating region @ 40 °C (104 °F)
- = Intermittent operating region, 450 mm (18 in.) stroke length only
- = Intermittent operating region, 076...300 mm (3...12 in.) stroke lengths

Additional Resources

These documents contain additional information concerning related products from Rockwell Automation.

Resource	Description
Kinetix Rotary Motion Specifications, publication KNX-TD001	Product specifications for Kinetix VP, MP-Series (Bulletin MPL, MPM, MPF, MPS), TL-Series™, RDD-Series™, and HPK-Series™ rotary motors.
Kinetix Servo Drives Specifications, publication KNX-TD003	Product specifications for Kinetix Integrated Motion over the EtherNet/IP network, Integrated Motion over sercos interface, EtherNet/IP networking, and component servo drive families.
Kinetix Motion Accessories Specifications, publication KNX-TD004	Product specifications for Bulletin 2090 motor and interface cables, low-profile connector kits, drive power components, and other servo drive accessory items.
Kinetix Motion Control Selection Guide, publication KNX-SG001	Overview of Kinetix servo drives, motors, actuators, and motion accessories designed to help make initial decisions for the motion control products best suited for your system requirements.
Kinetix 5700 Drive Systems, publication KNX-RM010	System design guide to determine and select the required (drive specific) drive module, power accessory, connector kit, motor cable, and interface cable catalog numbers for your drive and motor/actuator motion control system. Included are system performance specifications and torque/speed curves (rotary motion) and force/velocity curves (linear motion) for your motion application.
Kinetix 6000 and Kinetix 6200/6500 Drive Systems Design Guide, publication KNX-RM003	
Kinetix 300/350 Drive Systems Design Guide, publication KNX-RM004	
Kinetix 3 Drive Systems Design Guide, publication KNX-RM005	
Kinetix 2000 Drive Systems Design Guide, publication KNX-RM006	
Kinetix 7000 Drive Systems Design Guide, publication GMC-RM007	
Kinetix 5500 Servo Drives User Manual, publication 2198-UM001	Information on installing, configuring, startup, troubleshooting, and applications for your Kinetix servo drive system.
System Design for Control of Electrical Noise Reference Manual, publication GMC-RM001	Information, examples, and techniques designed to minimize system failures caused by electrical noise.
ControlLogix Selection Guide, publication 1756-SG001	Information to determine which ControlLogix controller fits your application and the product specifications to help design a ControlLogix system and select the appropriate components.
CompactLogix Selection Guide, publication 1769-SG001	Information to determine which CompactLogix controller fits your application and the product specifications to help design a CompactLogix system and select the appropriate components.
Industrial Ethernet Media Brochure, publication 1585-BR001	Information to determine which Bulletin 1585 Ethernet cable fits your application and the product specifications to help select the appropriate components.
Motion Analyzer System Sizing and Selection Tool website https://motionanalyzer.rockwellautomation.com/	Comprehensive motion application sizing tool used for analysis, optimization, selection, and validation of your Kinetix Motion Control system.
Rockwell Automation Configuration and Selection Tools, website http://ab.rockwellautomation.com	Online product selection and system configuration tools, including AutoCad (DXF) drawings.
Rockwell Automation Industrial Automation Glossary, publication AG-7.1	A glossary of industrial automation terms and abbreviations.

You can view or download publications at <http://www.rockwellautomation.com/global/literature-library/overview.page>.

Notes:

Rockwell Automation Support

Use the following resources to access support information.

Technical Support Center	Knowledgebase Articles, How-to Videos, FAQs, Chat, User Forums, and Product Notification Updates.	www.rockwellautomation.com/knowledgebase
Local Technical Support Phone Numbers	Locate the phone number for your country.	www.rockwellautomation.com/global/support/get-support-now.page
Direct Dial Codes	Find the Direct Dial Code for your product. Use the code to route your call directly to a technical support engineer.	www.rockwellautomation.com/global/support/direct-dial.page
Literature Library	Installation Instructions, Manuals, Brochures, and Technical Data.	www.rockwellautomation.com/literature
Product Compatibility and Download Center (PCDC)	Get help determining how products interact, check features and capabilities, and find associated firmware.	www.rockwellautomation.com/global/support/pcdc.page

Documentation Feedback

Your comments will help us serve your documentation needs better. If you have any suggestions on how to improve this document, complete the How Are We Doing? form at http://literature.rockwellautomation.com/idc/groups/literature/documents/du/ra-du002_-en-e.pdf.

Rockwell Automation maintains current product environmental information on its website at <http://www.rockwellautomation.com/rockwellautomation/about-us/sustainability-ethics/product-environmental-compliance.page>.

Allen-Bradley, CompactLogix, ControlLogix, GuardLogix, HPK-Series, Kinetix, LISTEN. THINK. SOLVE., MP-Series, PanelView Plus, POINT Guard I/O, POINT I/O, RDD-Series, Rockwell Automation, Rockwell Software, Stratix, Studio 5000 Logix Designer, and TL-Series are trademarks of Rockwell Automation, Inc.

EtherNet/IP is a trademark of ODVA, Inc.

Trademarks not belonging to Rockwell Automation are property of their respective companies.

Rockwell Otomasyon Ticaret A.Ş., Kar Plaza İş Merkezi E Blok Kat:6 34752 İçerenköy, İstanbul, Tel: +90 (216) 5698400

www.rockwellautomation.com

Power, Control and Information Solutions Headquarters

Americas: Rockwell Automation, 1201 South Second Street, Milwaukee, WI 53204-2496 USA, Tel: (1) 414.382.2000, Fax: (1) 414.382.4444

Europe/Middle East/Africa: Rockwell Automation NV, Pegasus Park, De Kleetlaan 12a, 1831 Diegem, Belgium, Tel: (32) 2 663 0600, Fax: (32) 2 663 0640

Asia Pacific: Rockwell Automation, Level 14, Core F, Cyberport 3, 100 Cyberport Road, Hong Kong, Tel: (852) 2887 4788, Fax: (852) 2508 1846

Publication KNX-RM009C-EN-P - May 2019

Supersedes Publication KNX-RM009B-EN-P - February 2017

Copyright © 2019 Rockwell Automation, Inc. All rights reserved. Printed in the U.S.A.