

Kinetix 5700 Drive Systems

Catalog Numbers 2198-P031, 2198-P070, 2198-P141, 2198-P208, 2198-RP088, 2198-RP200, 2198-RP263, 2198-RP312, 2198-S086-ERS3, 2198-S130-ERS3, 2198-S160-ERS3, 2198-S263-ERS3, 2198-S312-ERS3, 2198-S086-ERS4, 2198-S130-ERS4, 2198-S160-ERS4, 2198-S263-ERS4, 2198-S312-ERS4, 2198-D006-ERS3, 2198-D012-ERS3, 2198-D020-ERS3, 2198-D032-ERS3, 2198-D057-ERS3, 2198-D006-ERS4, 2198-D012-ERS4, 2198-D020-ERS4, 2198-D032-ERS4, 2198-D057-ERS4, 2198-CAPMOD-2240, 2198-DCBUSCOND-RP312, 2198-CAPMOD-DCBUS-IO

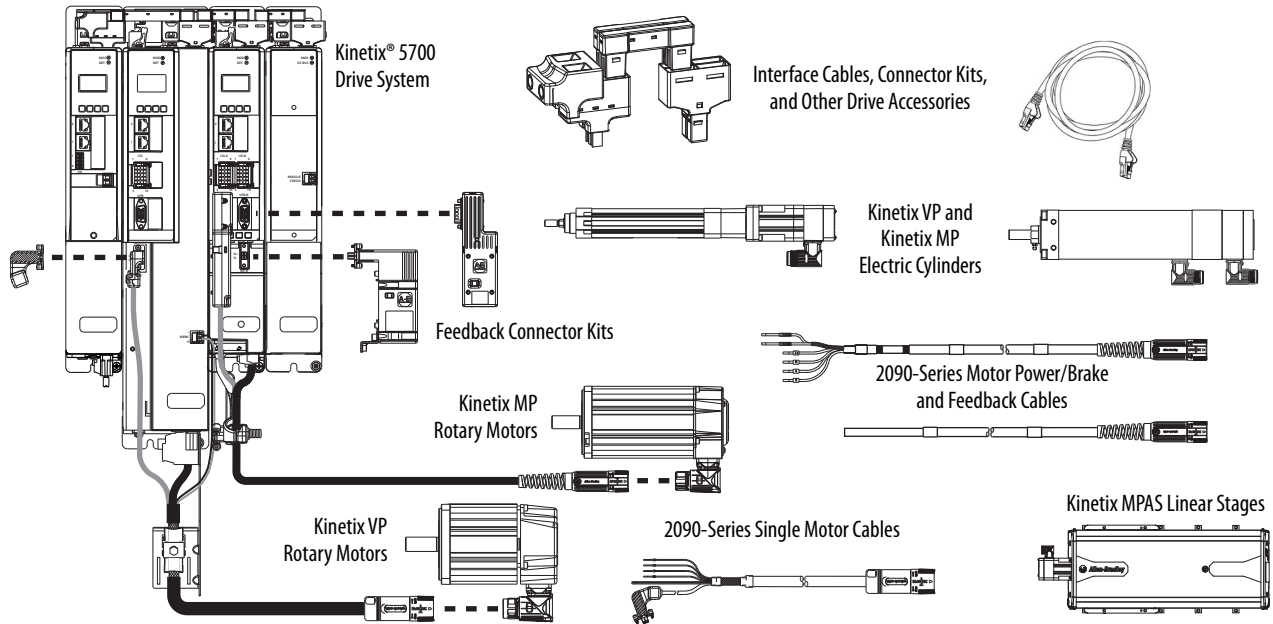

Topic	Page
Summary of Changes	2
Introduction	2
Kinetix 5700 System Power Supply Options	3
Functional Safety Configuration Options	6
Determine What You Need	10
Kinetix 5700 Shared-bus System Examples	15
2090-Series Single Motor Cable Overview	18
2090-Series Motor Power/Brake and Feedback Cables Overview	19
Rotary Motion System Combinations	
Kinetix VPL Low-inertia Motors	21
Kinetix VPC Continuous-duty Motors	30
Kinetix VPF Food-grade Motors	51
Kinetix VPH Hygienic Stainless-steel Motors	57
Kinetix VPS Stainless-steel Motors	62

Topic, continued	Page
Kinetix MPL Low-inertia Motors	63
Kinetix MPM Medium-inertia Motors	71
Kinetix MPF Food-grade Motors	79
Kinetix MPS Stainless-steel Motors	81
Kinetix HPK Asynchronous Servo Motors	83
Kinetix RDB Direct-drive Motors	87
Linear Motion System Combinations	
LDAT-Series Integrated Linear Thrusters	93
Kinetix MPAS Integrated Linear Stages	105
Kinetix VPAR Electric Cylinders	108
Kinetix MPAR Electric Cylinders	110
Kinetix MPAI Heavy-duty Electric Cylinders	112
LDC-Series™ Iron Core Linear Motors	117
Additional Resources	123



Summary of Changes

This publication contains new and updated information as indicated in the following table.

Topic	Page
Added VPC-B3004x-M servo motor with multi-turn encoder to the feedback configuration example, and other places.	14, 19, 30
Added compatibility with 2090-CSxM1xx-xxVAxx (PVC) and 2090-CSBM1xx-xxLFxx (Halogen-free PUR) single motor-cables.	18 and throughout
Corrected Kinetix VPL (400V-class) motor cable combinations (errors in Kinetix VPL motor and cable AWG).	21
Added Kinetix VPC motor without fan (A option) to cable combinations tables, performance table, and torque/speed and power/speed curves.	30...50
Corrected Kinetix VPF (400V-class) motor cable combinations (errors in Kinetix VPF motor and cable AWG).	51
Corrected Kinetix VPH (400V-class) motor cable combinations (errors in Kinetix VPH motor and cable AWG).	57
Corrected Kinetix VPH (400V-class) motor performance specifications (errors in Kinetix VPH peak stall-current values).	57...61

Introduction

Use this publication when your application includes the Kinetix 5700 drive family and Kinetix VP motors and actuators or any of the other compatible Allen-Bradley® motors and actuators. Other Allen-Bradley motors and actuators require the 2198-K57CK-D15M feedback connector kit or 2198-H2DCK feedback converter kit. For more Kinetix drive and motor information, see Motion Analyzer or the Kinetix Motion Control Selection Guide, publication [KNX-SG001](#).

The purpose of this publication is to assist you in identifying the drive system components and accessory items that are needed for your Kinetix 5700 drive system. Diagrams in this publication illustrate how many of the common drive accessories are used in a typical system. See the Kinetix Servo Drives Specifications Technical Data, publication [KNX-TD003](#), for detailed accessory descriptions and specifications.

The drive and motor/actuator system combinations include the following:

- Motor/cable combinations table
- Drive and motor performance specifications table
- Torque/speed curves with each motor matched to the drive that provides optimum performance

Performance specification data and curves reflect nominal system performance of a typical system with motor/drive at rated ambient temperature and line voltage. For additional information on ambients, line conditions, and valid combinations that are not shown in this publication, refer to the Motion Analyzer system sizing and selection tool.

IMPORTANT These system combinations do not include all possible motor/drive combinations. See Motion Analyzer for system sizing, selection, and to verify compatibility. Access Motion Analyzer at <https://motionanalyzer.rockwellautomation.com>.

CIP Security

CIP Security™ is a standard, open-source communication method that helps to provide a secure data transport across an EtherNet/IP network. It lets CIP-connected devices authenticate each other before transmitting and receiving data.

CIP Security uses the following security properties to help devices protect themselves from malicious communication:

- Device Identity and Authentication
- Data Integrity and Authentication
- Data Confidentiality

Rockwell Automation uses the following products to implement CIP Security:

- FactoryTalk® Services Platform, version 6.11 or later, with the following components enabled:
 - FactoryTalk Policy Manager
 - FactoryTalk System Services
- FactoryTalk Linx, version 6.11 or later
- Studio 5000® Design Environment, version 32.00.00 or later
- CIP Security-enabled Rockwell Automation® products, for example, the product described in this publication

For more information on CIP Security, including which products support CIP Security, see the CIP Security with Rockwell Automation Products Application Technique, publication [SECURE-AT001](#).

Kinetix 5700 System Power Supply Options

A single 2198-Pxxx DC-bus (converter) power supply can supply the Kinetix 5700 drive system with 458...747V shared DC-bus power (~~7...46 kW~~). For additional output power (kW) you can install two or three 2198-P208 DC-bus power supplies. You can also extend the DC-bus to additional inverter clusters via accessory modules.

The 2198-RPxxx regenerative bus supply (24...140 kW) provides full-line motoring and regenerative power to and from the Kinetix 5700 common DC-bus system. You can configure the regenerative bus supply to provide active DC-bus voltage regulation or passive AC rectification like the DC-bus power supply. In addition, you can extend the DC-bus voltage to additional inverter clusters via accessory modules. The regenerative bus supply is also compatible with Kinetix 7000, Kinetix 6000, Kinetix 6200, Kinetix 6500, PowerFlex® 755 drives, and other select PowerFlex drives.

DC-bus Power Supply Input Power Configurations

In this example, AC input power is fed to the DC-bus (converter) power supply. One single-axis (inverter) module and two dual-axis (inverter) modules support five axes of motion. This example includes the following features:

- The DC-bus power supply is mounted on the far left with the inverters and capacitor module positioned on the right, but the reverse mounting order (right to left) is also possible.
- Digital inputs are wired to sensors and the control circuitry at the IOD connectors. The contactor-enable relay helps protect the DC-bus power supply in the event of shutdown fault conditions.
- The capacitor module adds to the total system capacitance.

Other features and configurations include the following:

- Configure two or three 2198-P208 DC-bus (converter) power supplies that all receive AC input power and feed the inverter modules (including 2198-S263-ERSx and 2198-S312-ERSx single-axis inverters) for increased output power.
- Extend the same 458...747V DC-bus voltage to two or more drive clusters in the same cabinet.
 - Kinetix 5700 accessory modules provide connection points for the extended DC-bus.
 - Two adjacent accessory modules are required for each cluster when the extended DC-bus system current exceeds 104 A.
- The DC-bus power supply supports iTRAK power supplies and up to 40 iTRAK motor modules, depending on cable lengths and iTRAK motor-module power consumption.

DC-bus Power Supply Installation Example

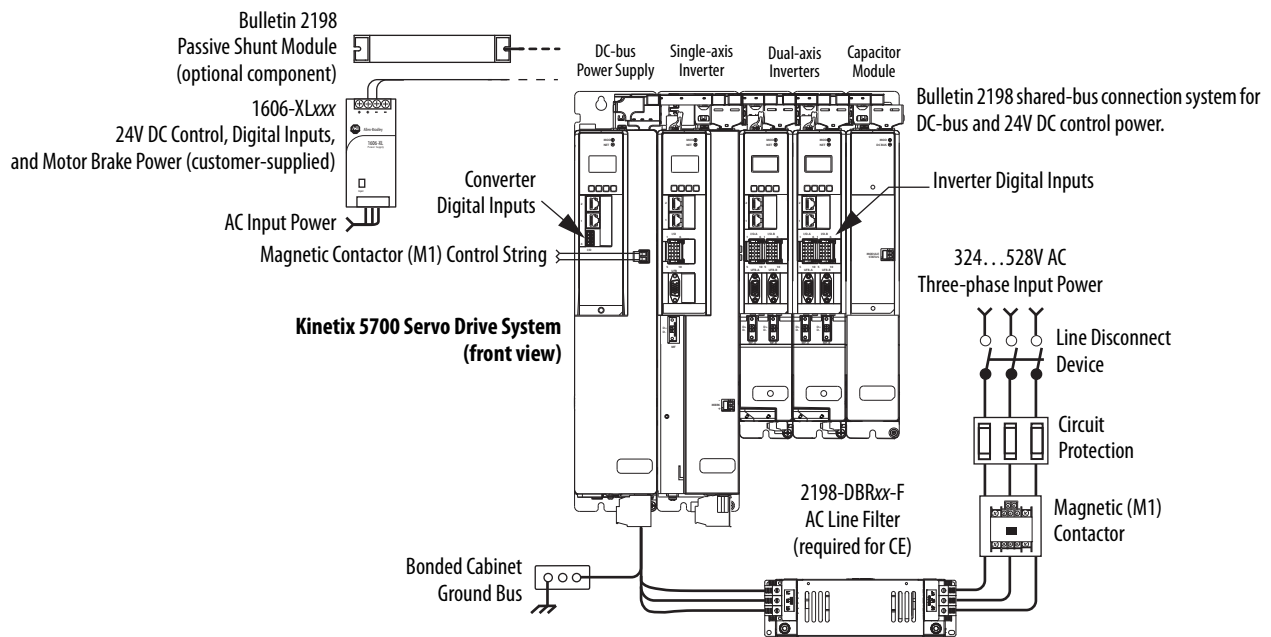

Regenerative Bus Supply Input Power Configurations

In this example, AC input power is fed to the regenerative bus supply. One single-axis (inverter) module and two dual-axis (inverter) modules support five axes of motion.

This example includes the following features:

- The regenerative bus supply is mounted on the far left with the inverters and DC-bus conditioner module positioned on the right, but the reverse mounting order (right to left) is also possible.
- Integrated LC filter minimizes AC line harmonics from the AC power source and saves significant panel-space and installation costs.
- Digital inputs are wired to sensors and the control circuitry at the IOD connectors. The contactor-enable relay helps protect the DC-bus power supply in the event of shutdown fault conditions.
- The DC-bus conditioner module is required when the combined motor cable length exceeds 400 m (1312 ft) and/or when the AC input-power source type is impedance-grounded.

Other features and configurations include the following:

- Provides full-line motoring and regenerative power to and from a Kinetix 5700 common DC-bus system.
- Configure the regenerative bus supply to provide active DC-bus voltage regulation or passive AC rectification like the DC-bus power supply.
- Extend the same 458...747V DC-bus voltage to two or more extended clusters in the same cabinet.
 - Kinetix 5700 accessory modules provide connection points for the extended DC-bus.
 - The Kinetix 5700 servo drive system is capable of up to 208 A DC-bus current. Two adjacent accessory modules are required when the DC-bus system current exceeds 104 A.
- The regenerative bus supply supports iTRAK power supplies and up to 40 iTRAK motor modules, depending on cable lengths and iTRAK motor-module power consumption.

Regenerative Bus Supply Installation Example

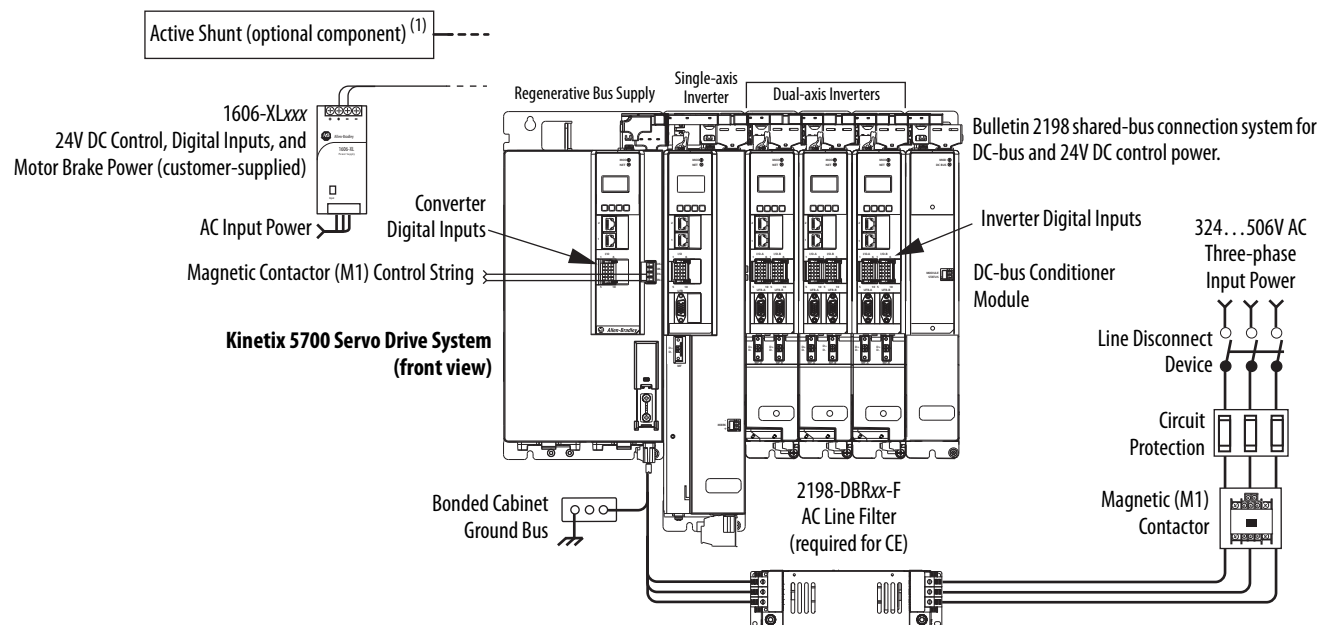

(1) See the Kinetix 5700 Servo Drives User Manual, publication [2198-UM002](#), for or more information on selection and wiring Encompass™ partner Powerohm active shunts.

Functional Safety Configuration Options

Kinetix 5700 servo drives are capable of safe torque-off (STO) and safe stop 1 (SS1) drive-based safety functions via hardwired connections or integrated over the EtherNet/IP network. In addition, safely limited speed (SLS) and other controller-based safety instructions are also possible. These examples illustrate the functional safety configuration options.

Hardwired Safety Configuration

Kinetix 5700 servo drives use the safe torque-off (STO) connector for wiring external safety devices and cascading hardwired safety connections from one drive to another.

Safe Torque-off (hardwired) Configuration

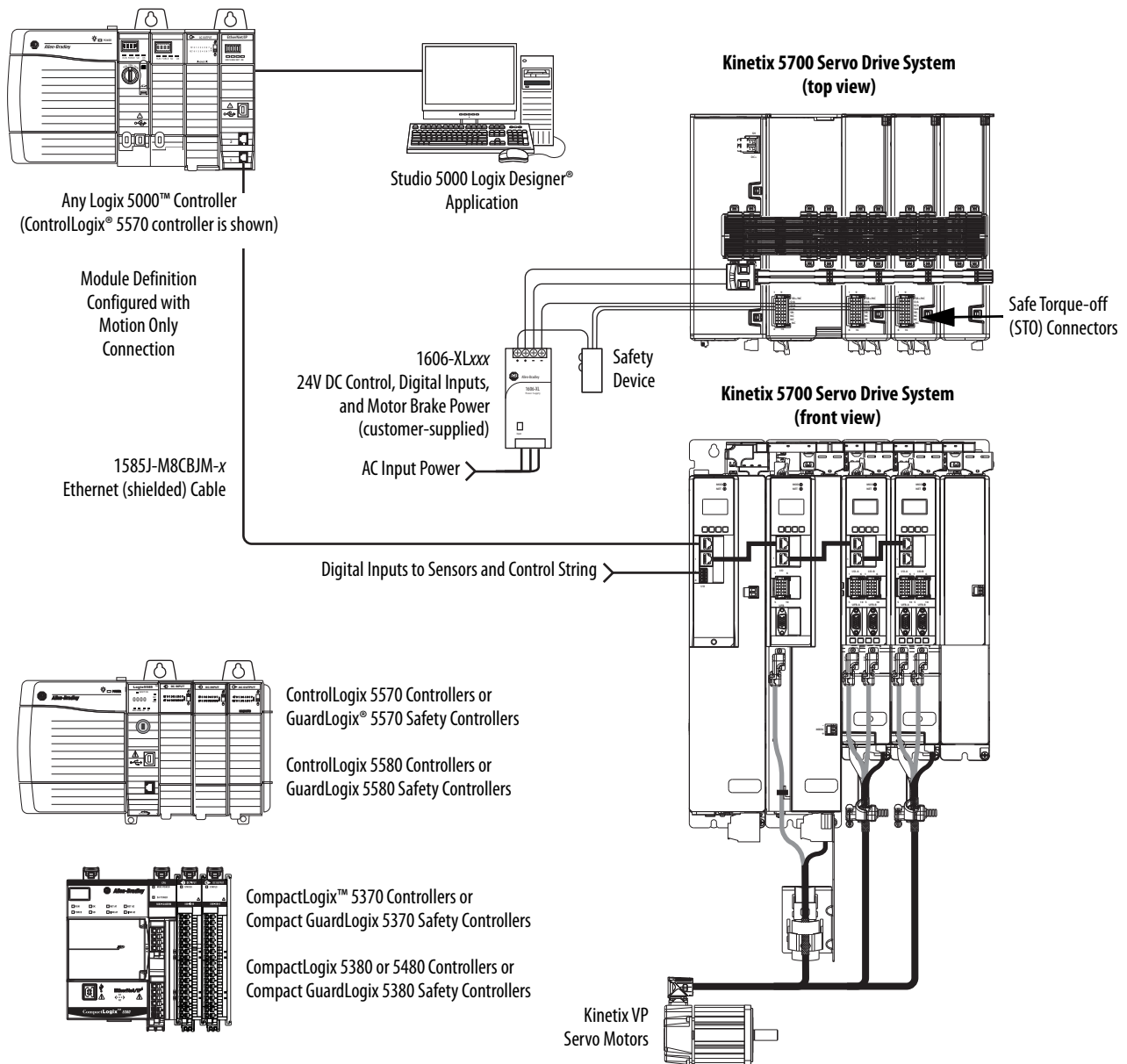

Integrated Safety Configurations

The GuardLogix or Compact GuardLogix safety controller issues the safe torque-off (STO) or safe stop (SS1) command over the EtherNet/IP network and the Kinetix 5700 servo drive executes the command.

In this example, a single GuardLogix safety controller makes the Motion and Safety connections.

IMPORTANT If only one controller is used in an application with Motion and Safety connections, it must be a GuardLogix or Compact GuardLogix safety controller. For more information, see the [Functional Safety and GuardLogix Controller Compatibility](#) table on [page 11](#).

Motion and Safety Configuration (single controller)

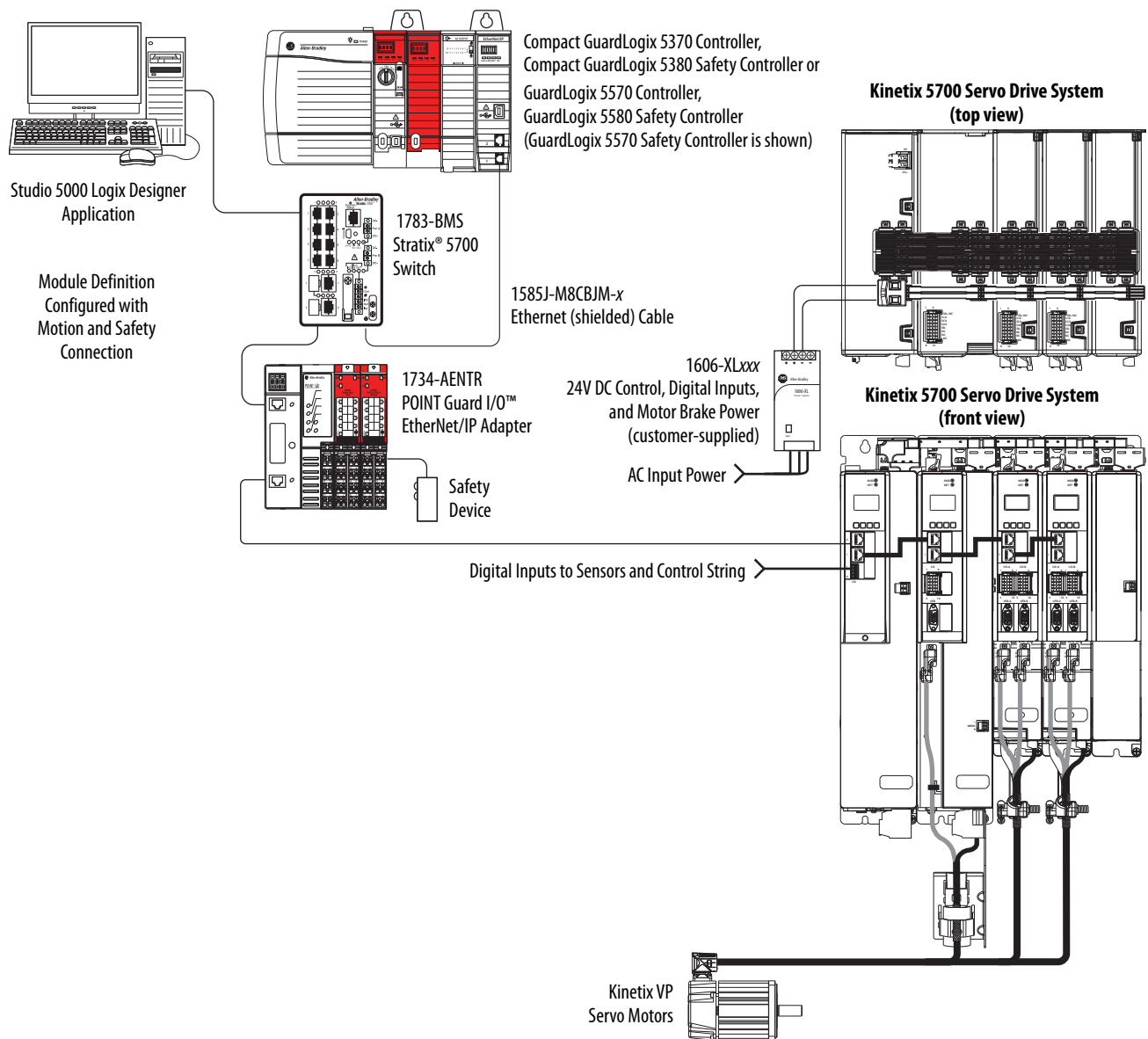

In this example, a non-safety controller makes the Motion Only connection and a separate GuardLogix safety controller makes the Safety Only connection.

IMPORTANT If two controllers are used in an application with Motion Only and Safety Only connections, the Safety Only connection must be a GuardLogix or Compact GuardLogix safety controller and the Motion Only connection must be any Logix 5000 controller. For more information, see the [Functional Safety and GuardLogix Controller Compatibility](#) table on [page 11](#).

Motion and Safety Configuration (multi-controller)

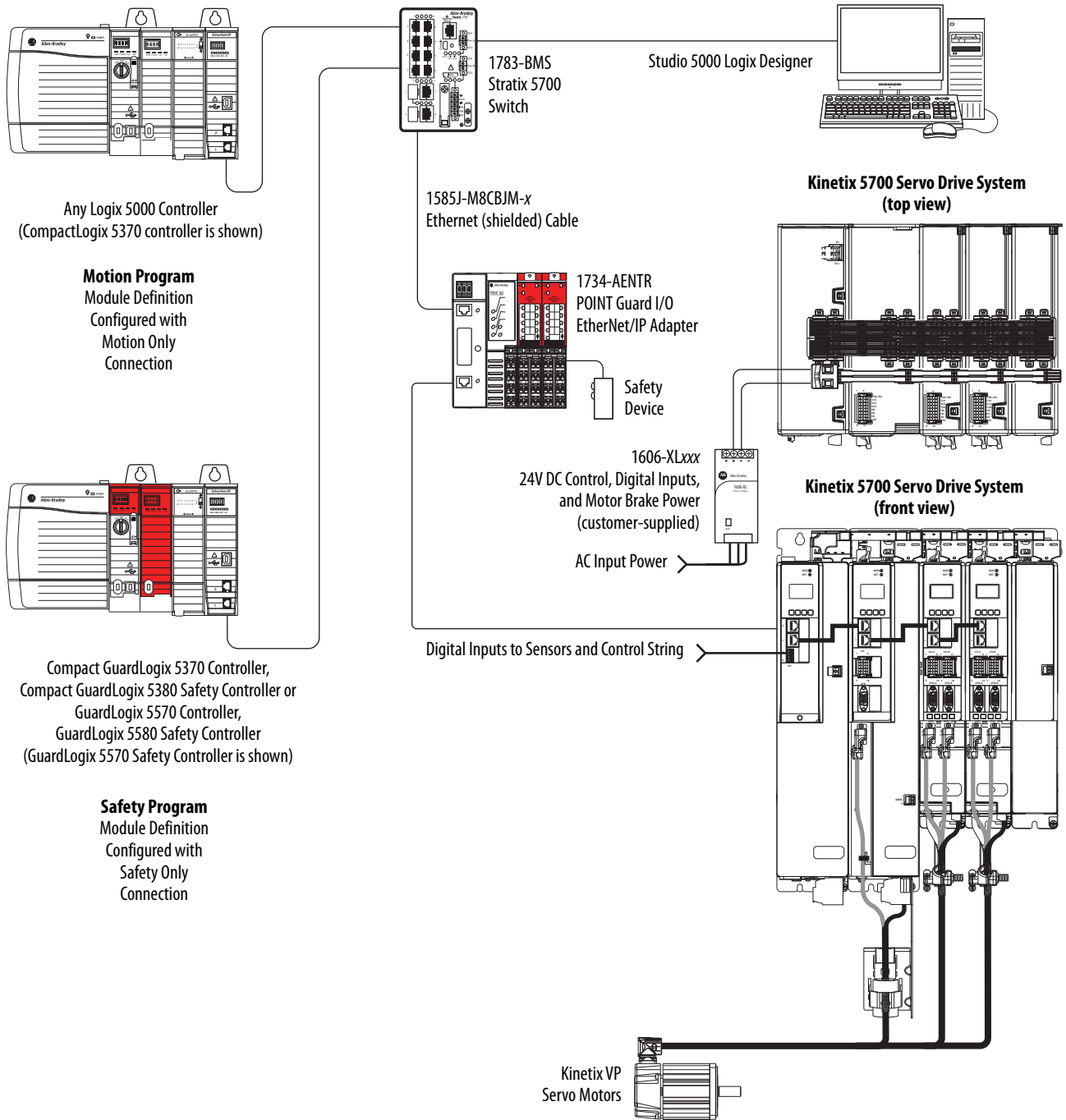

Safe Stop and Safe Monitor Configuration

Kinetix 5700 servo drives are capable of safe stop and safe monitor functions via drive-based and controller-based integrated safety over the EtherNet/IP network.

IMPORTANT For applications with safe stop and safe monitor safety functions, the GuardLogix 5580 or Compact GuardLogix 5380 controllers must be used. For more information, see the [Functional Safety and GuardLogix Controller Compatibility](#) table on [page 11](#).

In this example, the SS1 stopping function is used in a motion and safety controller-based configuration with dual-feedback monitoring.

Safe Motion-monitoring Configuration

Compact GuardLogix 5380 or GuardLogix 5580 Safety Controller (GuardLogix 5580 Safety Controller is shown)

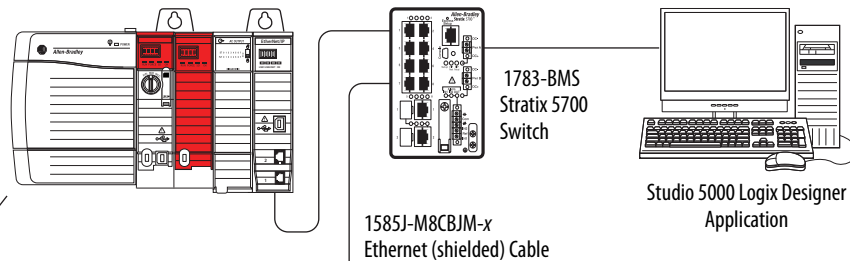

SS1	
Safe Stop 1	
Safety Control	SS1_Control_SA1
Restart Type	AUTOMATIC
Cold Start Type	AUTOMATIC
Stop Monitor Delay	50
Stop Delay	500
Standstill Speed	0.05
Decel Ref Speed	25.0
Decel Speed Tolerance	5.0
Feedback SFX	SFX_Control_SA1
Request	SS1_Request_SA1
Reset	SS1_Reset_SA1
SS1 Active	SDA1:SO.SS1Active1
SS1 Fault	SDA1:SO.SS1Fault1
Fault Type	0
Diagnostic Code	0

Controller-based Instruction Example

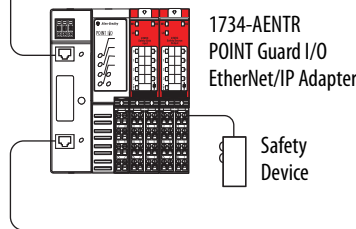

Kinetix 5700 Servo Drive System with Integrated Safety Functions

DSL feedback connector kit with primary feedback from the motor is hidden behind the universal feedback connector kit with secondary feedback from the external encoder.

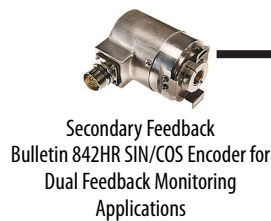

Position feedback is sent separately to the drive for safety and for motion control.

Secondary Feedback to UFB Connector

Primary Feedback to MF Connector

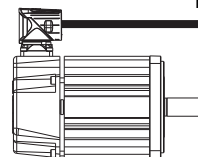

- Primary Feedback
- Kinetix VPL, VPF, or VPH servo motors with -W or -Q encoders
 - Kinetix VPAR) electric cylinders with -W or -Q encoders
 - Kinetix VPC) servo motors with -Q encoders

Determine What You Need

For each Kinetix 5700 drive system, the drive and motor/actuator catalog numbers are required to determine the motor cable catalog number. Ethernet cables and a 24V DC power supply are also required.

- 2198-KITCON-DSL (2-pin) connector kits are used for motor feedback from Kinetix VP motors and actuators (high-resolution absolute feedback). Kits are pre-assembled with the feedback wires on 2090-CSxM1DE single motor cables. Kits can also be purchased separately and used with 2090-CSxM1DG cables.
- 2198-K57CK-D15M (15-pin) connector kits are used for new or existing motor feedback connections to any other compatible Allen-Bradley motor or actuator with non-DSL encoder feedback.
- 2198-H2DCK feedback converter kits (series B or later) are for feedback-only (master) or dual-loop (load) feedback when the 15-pin universal feedback (UFB) connector is used for Hiperface motor feedback.

Optional equipment includes:

- Kinetix 5700 capacitor module, DC-bus conditioner module, and extension module (accessory modules)
- Bulletin 2198 AC line filters
- Bulletin 2198 external passive shunt resistors (when the DC-bus power supply is the converter)
- External (Powerohm) active shunt (when DC-bus power supply or regenerative bus supply is the converter)
- 2198-ABQE encoder output module
- 24V input wiring connectors, T-connectors, and bus-bars for the 24V shared-bus connection system
- Bulletin 1321 line reactors
- Kinetix 5700 system mounting toolkit

Kinetix 5700 Drive Modules

Kinetix 5700 Drive Modules	Module Cat. No.	Continuous Output Current to Bus A _{DC} rms	Module Width mm	Continuous Output Power kW	Continuous Output Current A 0-pk	Features	
DC-bus Power Supply (324...528V AC rms, three-phase input power)	2198-P031 2198-P070	10.5 25.5	55	7 17	-	<ul style="list-style-type: none"> • Multi-axis, three-phase DC-bus sharing converter • Two or three power supplies in parallel (2198-P208 units only) increase power output to Bulletin 2198 single-axis and dual-axis inverters • Extended DC-bus voltage to another Kinetix 5700 inverter cluster 	
	2198-P141 2198-P208	46.9 69.2	85	31 46			
Regenerative Bus ⁽¹⁾ Supply (324...506V AC rms, three-phase input power)	2198-RP088	35.3	165	24	-	<ul style="list-style-type: none"> • Provides full-line motoring and regenerative power to and from a Kinetix 5700 common DC-bus system • Integrated LC filter minimizes AC line harmonics from the AC power source and saves significant panel-space and installation costs • Can be configured to provide active DC-bus voltage regulation or passive AC rectification like the DC-bus power supply • Extended DC-bus voltage to another Kinetix 5700 inverter cluster 	
	2198-RP200	100.0	275	67			
	2198-RP263	176.4	440	119			
	2198-RP312	207.0	440	140			
Single-axis Inverters	2198-S086-ERS3 2198-S130-ERS3	2198-S086-ERS4 2198-S130-ERS4	85	29.7 44.9	60.8 91.9	2198-xxxx-ERS3 and 2198-xxxx-ERS4 drives: <ul style="list-style-type: none"> • Kinetix VP and Kinetix MP servo motor compatibility • Kinetix HPK asynchronous servo motor compatibility • Kinetix RDB direct-drive motor compatibility • Kinetix VP and Kinetix MP linear actuator compatibility • LDAT-Series linear thruster compatibility • LDC-Series linear motor compatibility • Hardwired and Integrated STO 2198-xxxx-ERS3 (series B) drives add: <ul style="list-style-type: none"> • Integrated (drive-based) Timed SS1 2198-xxxx-ERS4 drives add: <ul style="list-style-type: none"> • Integrated (drive-based) Timed SS1, Monitored SS1 • Integrated (controller-based) SS1, SS2, S0S, SLS, ⁽²⁾ SLP, SDI, SFX, SBC 	
	2198-S160-ERS3	2198-S160-ERS4	100	60.1	120.2		
	2198-S263-ERS3 2198-S312-ERS3	2198-S263-ERS4 2198-S312-ERS4	220	90 112	212.1 271.5		
Dual-axis Inverters	2198-D006-ERS3 2198-D012-ERS3 2198-D020-ERS3	2198-D006-ERS4 2198-D012-ERS4 2198-D020-ERS4	55	1.7 3.4 5.5	3.5 7.0 11.3	2198-xxxx-ERS3 (series B) drives add: <ul style="list-style-type: none"> • Integrated (drive-based) Timed SS1 2198-xxxx-ERS4 drives add: <ul style="list-style-type: none"> • Integrated (drive-based) Timed SS1, Monitored SS1 • Integrated (controller-based) SS1, SS2, S0S, SLS, ⁽²⁾ SLP, SDI, SFX, SBC 	
	2198-D032-ERS3	2198-D032-ERS4		8.9	18.3		
	2198-D057-ERS3	2198-D057-ERS4		85	15.9		32.5

(1) Applies when DC-bus voltage regulation is enabled. If DC-bus voltage regulation is not enabled, the input voltage range is 324...528V AC. For more information on these two modes of operation, see the Kinetix 5700 Servo Drives User Manual, publication [2198-UM002](#).

(2) See the Kinetix 5700 Safe Monitor Functions Safety Reference Manual, publication [2198-RM001](#), for more information on these Drive Safety instructions.

IMPORTANT Throughout this publication, when the Kinetix 5700 inverter catalog number ends in -ERSx, for example 2198-D057-ERSx, the variable (x) indicates that the inverter catalog number (using this example) can be 2198-D057-ERS3 or 2198-D057-ERS4.

Functional Safety and GuardLogix Controller Compatibility

Safety Application Mode ⁽¹⁾	Safety Functions	Minimum Drive Module ⁽³⁾ Required	Minimum Controller ⁽⁴⁾ Required	Studio 5000 Logix Designer
Hardwired	Safe Torque-off (STO)	2198-xxxx-ERS3 (series A)	<ul style="list-style-type: none"> ControlLogix 5570 CompactLogix 5370 	Version 26 or later
Networked (integrated)	Safe Torque-off (STO)	2198-xxxx-ERS3 (series A)	<ul style="list-style-type: none"> GuardLogix 5580 CompactLogix 5380 	Version 31 or later
	Timed SS1	2198-xxxx-ERS3 (series B)		
	<ul style="list-style-type: none"> Timed SS1 ⁽²⁾ Monitored SS1 ⁽²⁾ Controller-based safety functions ⁽²⁾ 	2198-xxxx-ERS4		

(1) For 2198-Dxxx-ERS4 (dual-axis) inverters, you must configure axis 1 and 3 as either Networked or Hardwired, they cannot be mixed.

(2) See the Kinetix 5700 Safe Monitor Functions Safety Reference Manual, publication [2198-RM001](#), for more information on these Drive Safety instructions.

(3) Where a 2198-xxxx-ERS3 drive is specified, a 2198-xxxx-ERS4 drive is backwards compatible.

Where a 2198-xxxx-ERS3 (series A) drive is specified, a 2198-xxxx-ERS3 (series B) drive is backwards compatible.

(4) Where a ControlLogix or CompactLogix (non-safety) controller is specified, a GuardLogix or Compact GuardLogix controller is backwards compatible. Also, GuardLogix 5580 and Compact GuardLogix 5380 controllers are backwards compatible with GuardLogix 5570 and Compact GuardLogix 5370 controllers.

Required Drive Accessories

Drive Accessory	Description	Cat. No.
24V power supply ⁽¹⁾	24V DC for control power and motor brakes.	1606-XLxxx
Ethernet network cables	Double-ended, non-flex, shielded.	1585J-M8CBJM-x
	Double-ended, high-flex, shielded.	1585J-M8UBJM-x
Motor cables	<ul style="list-style-type: none"> Kinetix VPL, VPC, VPF, VPH, and VPS rotary motors. Kinetix MPL, MPM, MPF, and MPS, HPK, and RDB rotary motors. Kinetix MPAS, MPAR, and MPAL linear actuators. Kinetix VPAR linear actuators LDAT-Series linear thrusters and LDC-Series linear motors. 	Refer to the specific drive/motor combination for the motor cables required for your system.
Feedback connector kits	When using flying-lead cables, connector kits are required for wiring motor feedback and auxiliary feedback to the MF and/or UFB feedback connectors.	<ul style="list-style-type: none"> 2198-KITCON-DSL 2198-K57CK-D15M 2198-H2DCK
DC-bus connector kits	DC-bus links and end-caps are required to make DC-bus connections across the Kinetix 5700 drive system. These kits are included with each drive module and replacement kits are also available.	<ul style="list-style-type: none"> 2198-BARCON-xxxDC200 2198-KITCON-ENDCAP200

(1) The 24V DC control power supply and 24V power distribution maintains the Kinetix 5700 drive system control circuitry and requires a thorough evaluation. See the Kinetix 5700 Servo Drives User Manual, publication [2198-UM002](#), for points to consider when sizing such a system.

Optional Drive Accessories

Drive Accessory	Description	Cat. No.
Shared-bus connector kits	24V input wiring connectors, T-connectors, and bus bars for the 24V shared-bus connection system	<ul style="list-style-type: none"> 2198-TCON-24VDCIN36 2198-xxxx-P-T 2198-BARCON-xxDCAC100
Capacitor module	Use for energy storage and to extend the DC-bus voltage to another inverter cluster. Modules are zero-stacked with servo drives and use the shared-bus connection system to extend the external DC-bus voltage in applications up to 104 A. Can parallel with itself or with another accessory module for up to 208 A.	2198-CAPMOD-2240
Extension module	The extension module, paired with a capacitor module or DC-bus conditioner module, is used to extend the DC-bus voltage to another inverter cluster in systems with ≥ 104 A current and up to 208 A.	2198-CAPMOD-DCBUS-10
DC-bus conditioner module	Decreases the voltage stress on insulation components in an inverter system with long cable lengths. Modules are used in systems with an impedance-grounded AC power source and to extend the DC-bus voltage to another inverter cluster.	2198-DCBUSCOND-RP312
Encoder output module	The Allen-Bradley encoder output module is a DIN-rail mounted EtherNet/IP network-based standalone module capable of outputting encoder pulses to a customer-supplied peripheral device.	2198-ABQE
AC line filters	AC line conditioning for EMC (required to meet CE).	2198-DBRxx-F ⁽²⁾
Bulletin 2198 passive shunts	Panel-mount or cabinet-mount external passive shunt resistor.	2198-Rxxx

Optional Drive Accessories (continued)

Drive Accessory	Description	Cat. No.
Active shunts ⁽¹⁾	Powerohm active shunt module with built-in internal brake resistor.	<ul style="list-style-type: none"> PKBxxx PKBxxx-800
	Powerohm active shunt module without internal brake resistor. Bulletin PWB active shunts require an appropriately sized external brake resistor (purchased separately).	<ul style="list-style-type: none"> PWBxxx PWBxxx-800
Line reactors	Bulletin 1321 line reactors help keep equipment running longer by absorbing many of the power line disturbances that can shut down your power supply. Optional for use with 2198-RPxxx regenerative power supplies and with only one 2198-Pxxx DC-bus power supply, but recommended for all power supplies.	<ul style="list-style-type: none"> 1321-3Rxx-A 1321-3Rxx-B
System mounting toolkit	The system mounting toolkit is used to locate the drill-holes for your Kinetix 5700 drive system.	2198-K5700-MOUNTKIT
External auxiliary encoders	Allen-Bradley auxiliary feedback encoders.	Bulletin 842HR, 844D, 847H, and 847T

(1) Supplied by Encompass partner Powerohm Resistors, Inc. For product specifications, see <http://www.powerohm.com>.

(2) Bulletin 2198 three-phase AC line filters are available for use with DC-bus power supplies and regenerative bus supplies. Use 2198-DBxx-F filters as field replacements in existing installations that use DC-bus power supplies with inverter ground jumpers installed. Select 2198-DBRxx-F filters for all new systems and remove all inverter ground jumpers.

Kinetix 5700 Optional Accessories Example 1

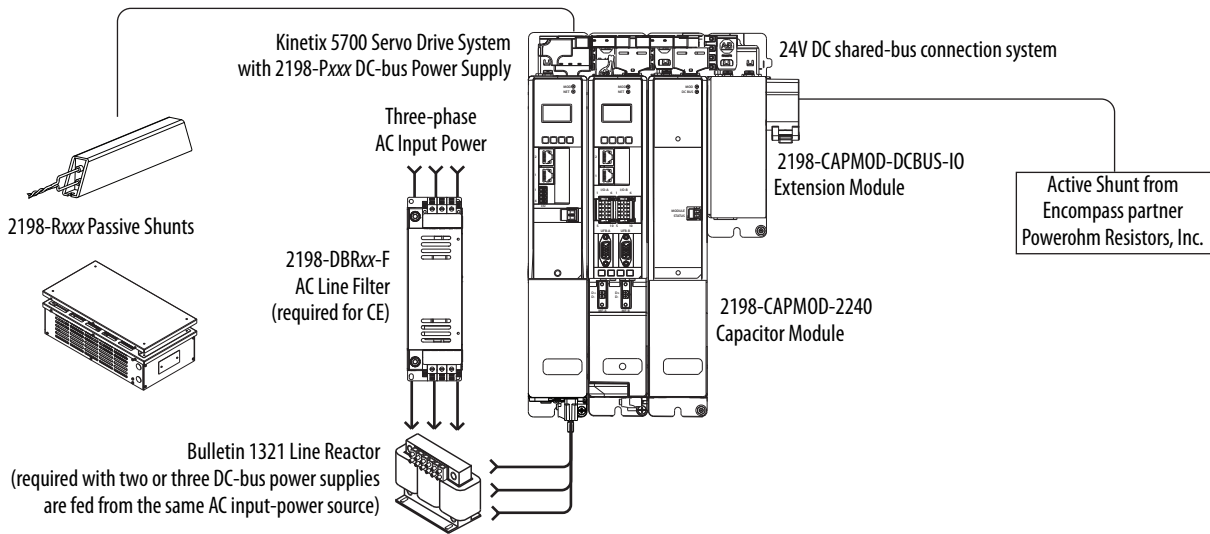

Kinetix 5700 Optional Accessories Example 2

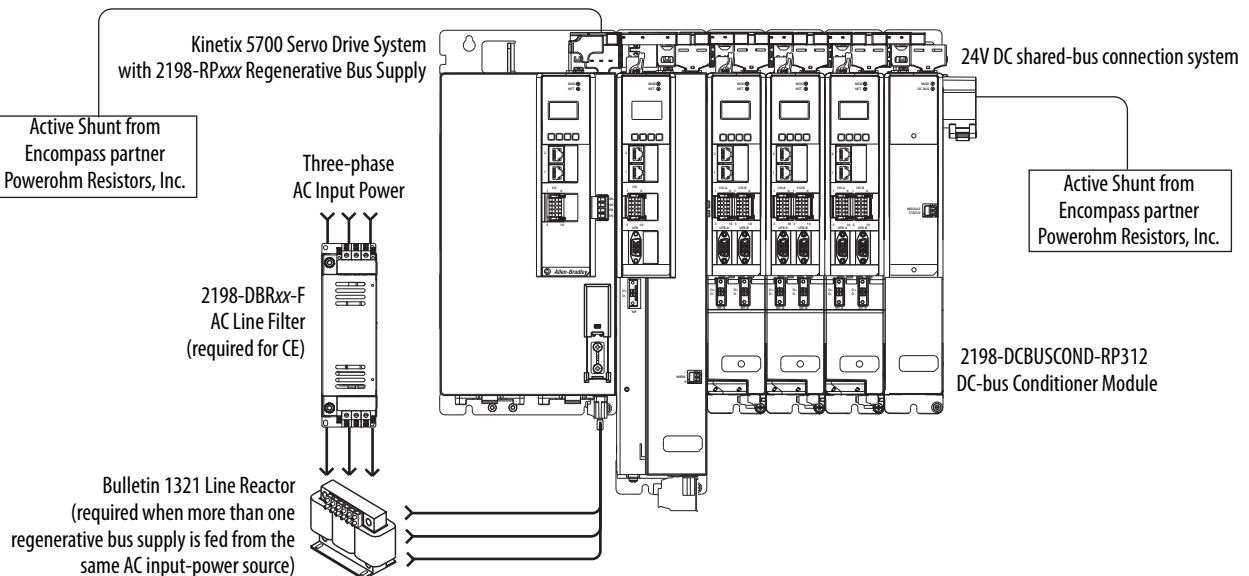

Encoder Output Module Example

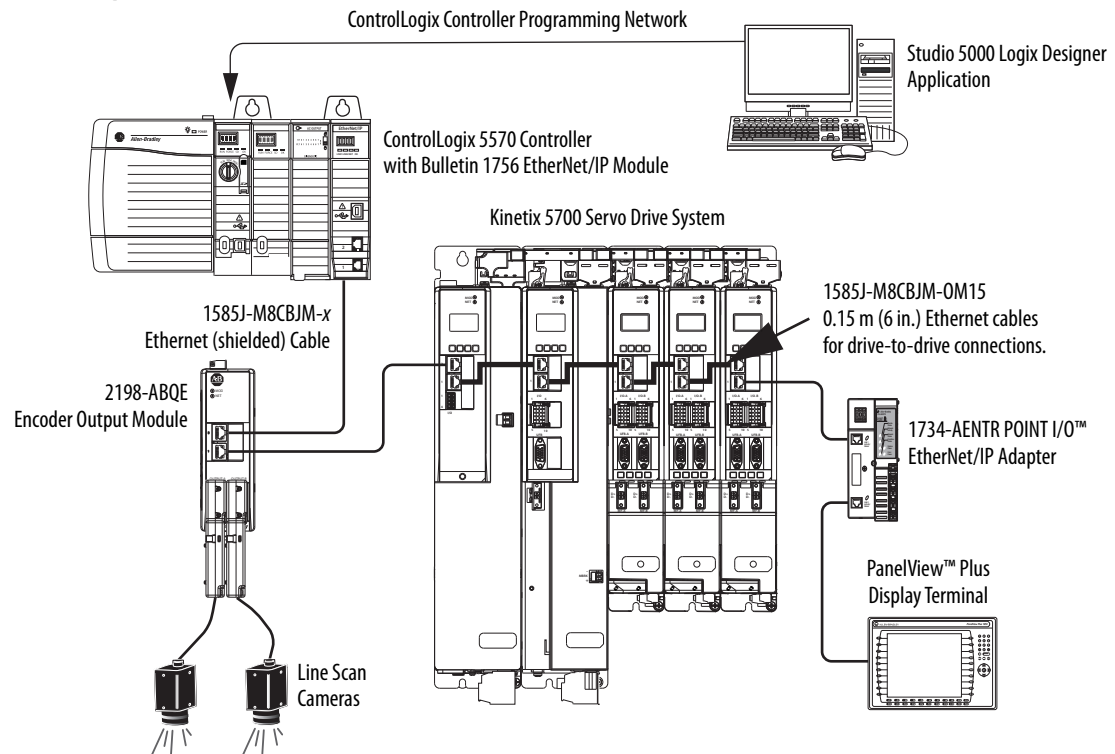

In this example, the encoder output module outputs encoder pulses to cameras used in line-scan vision systems. The module supports real and virtual axes for systems using integrated motion on the EtherNet/IP network.

Refer to the Kinetix Servo Drives Specifications Technical Data, publication [KNX-TD003](#), for detailed descriptions and additional specifications for the Kinetix 5700 drive accessories.

Feedback connections are made at the 2-pin motor feedback (MF) connector and the 15-pin universal feedback (UFB) connector. These examples illustrate how you can use the Bulletin 2198 connector kits for making these connections.

Feedback Configuration Example

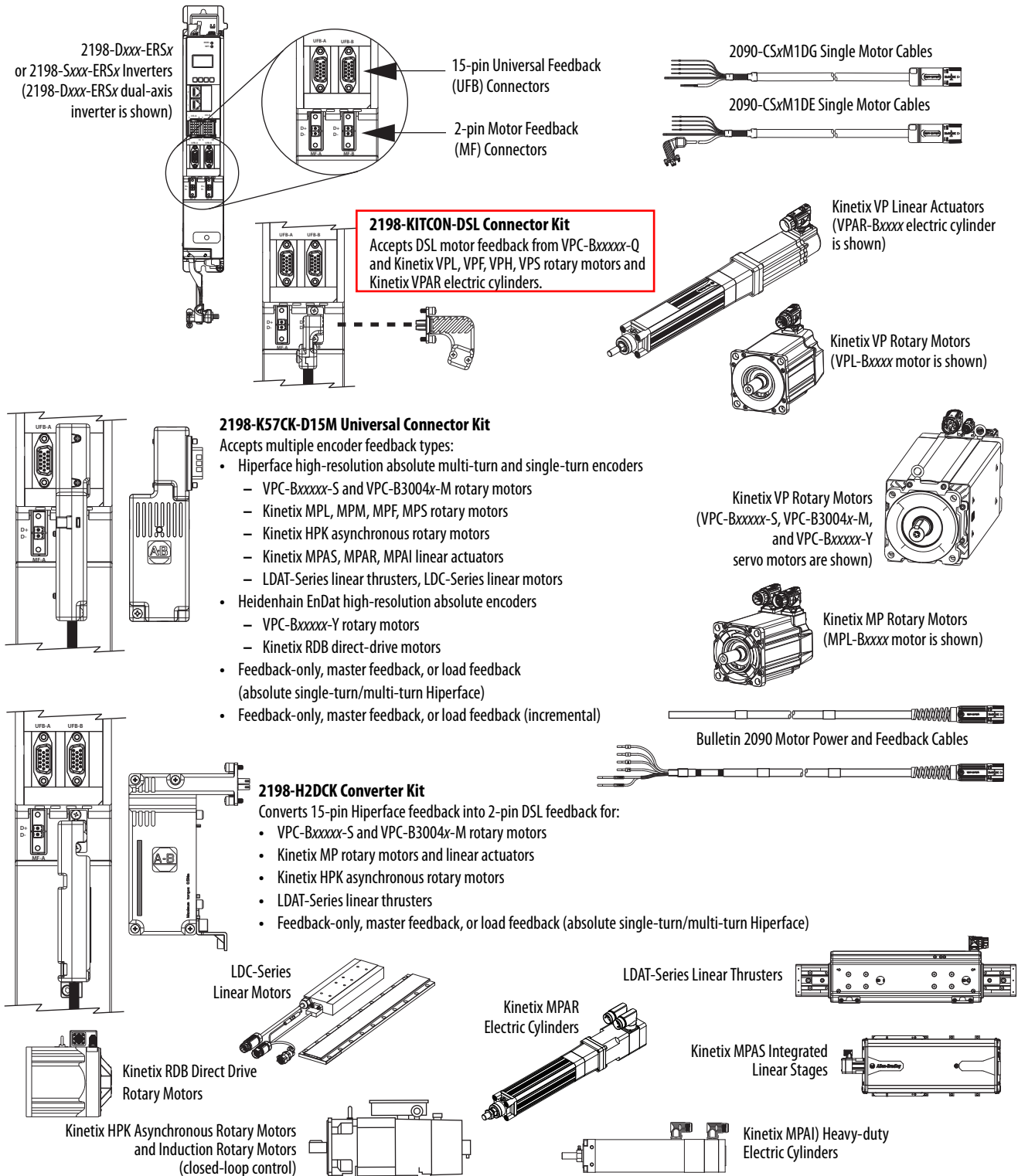

Refer to the Kinetix Servo Drives Specifications Technical Data, publication [KNX-TD003](#), for detailed descriptions and additional specifications for the Kinetix 5700 drive family.

Kinetix 5700 Shared-bus System Examples

These system examples illustrate how Kinetix 5700 servo drives and shared-bus accessories are used in typical shared-bus configurations. Engaging the zero-stack tab and cutout from one drive to another is required and makes efficient use of panel space. This is done to make sure that the drive connectors are spaced properly to accept the shared-bus connection system.

Zero-stack Tab and Cutout Example

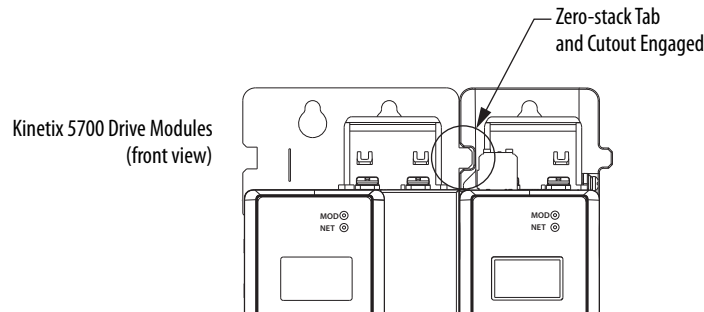

Refer to the Kinetix Servo Drives Specifications Technical Data, publication [KNX-TD003](#), for detailed descriptions and catalog numbers for the shared-bus connector kits.

DC-bus Link Connector Kits

In this example, three-phase DC-bus power is shared in a four-axis drive system. The DC-bus links and end caps are included with the drive modules. Replacement DC-bus links and end-caps are also available.

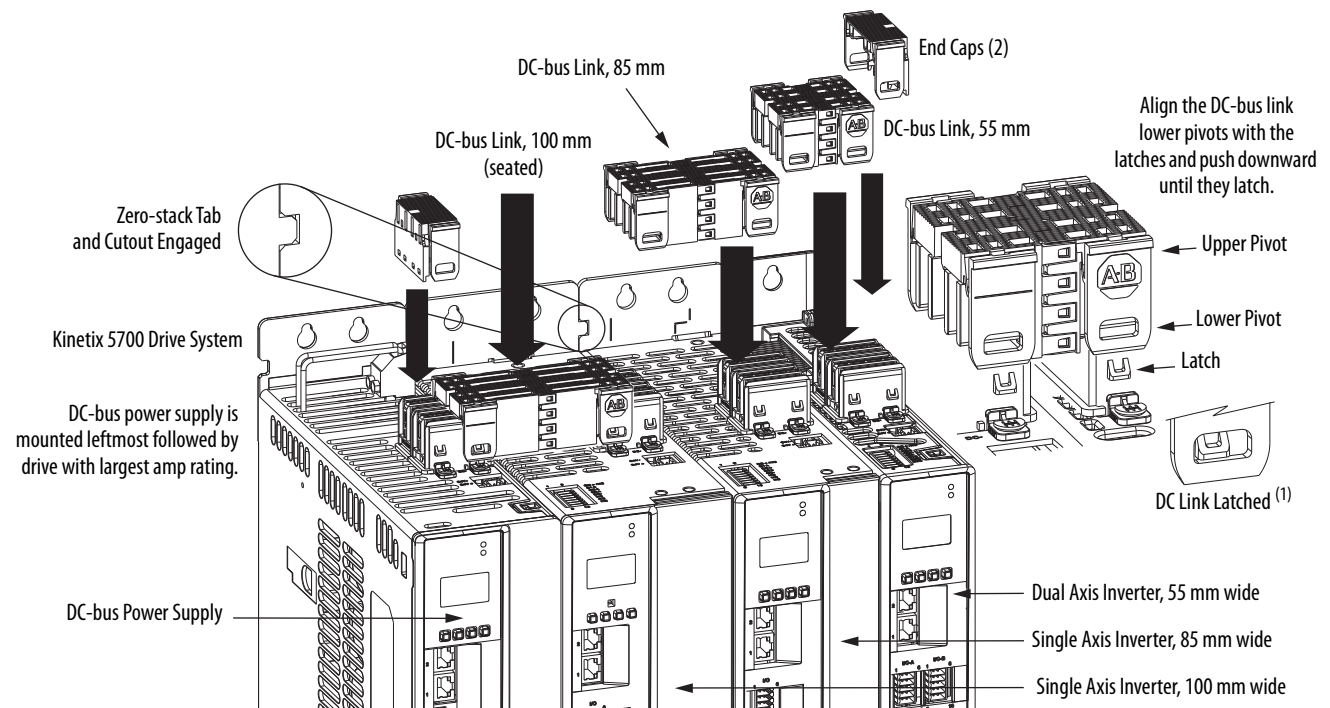

(1) DC-bus links latch on both sides when inserted into the DC-bus connectors. To remove the DC-bus link, depress both sets of upper pivots to unlatch the lower pivots and hold the DC-bus link firmly while pulling upward.

24V DC Shared-bus Connector Kits

In this DC-bus power supply example, 24V control power is shared from a single input. In high-axis-count systems, if the 40 A shared-bus current rating is exceeded, you can add another 2198-TCON-24VDCIN36 input connector. Refer to the Kinetix 5700 Servo Drives User Manual, publication [2198-UM002](#), for system sizing information.

Shared 24V DC Installation Example 1

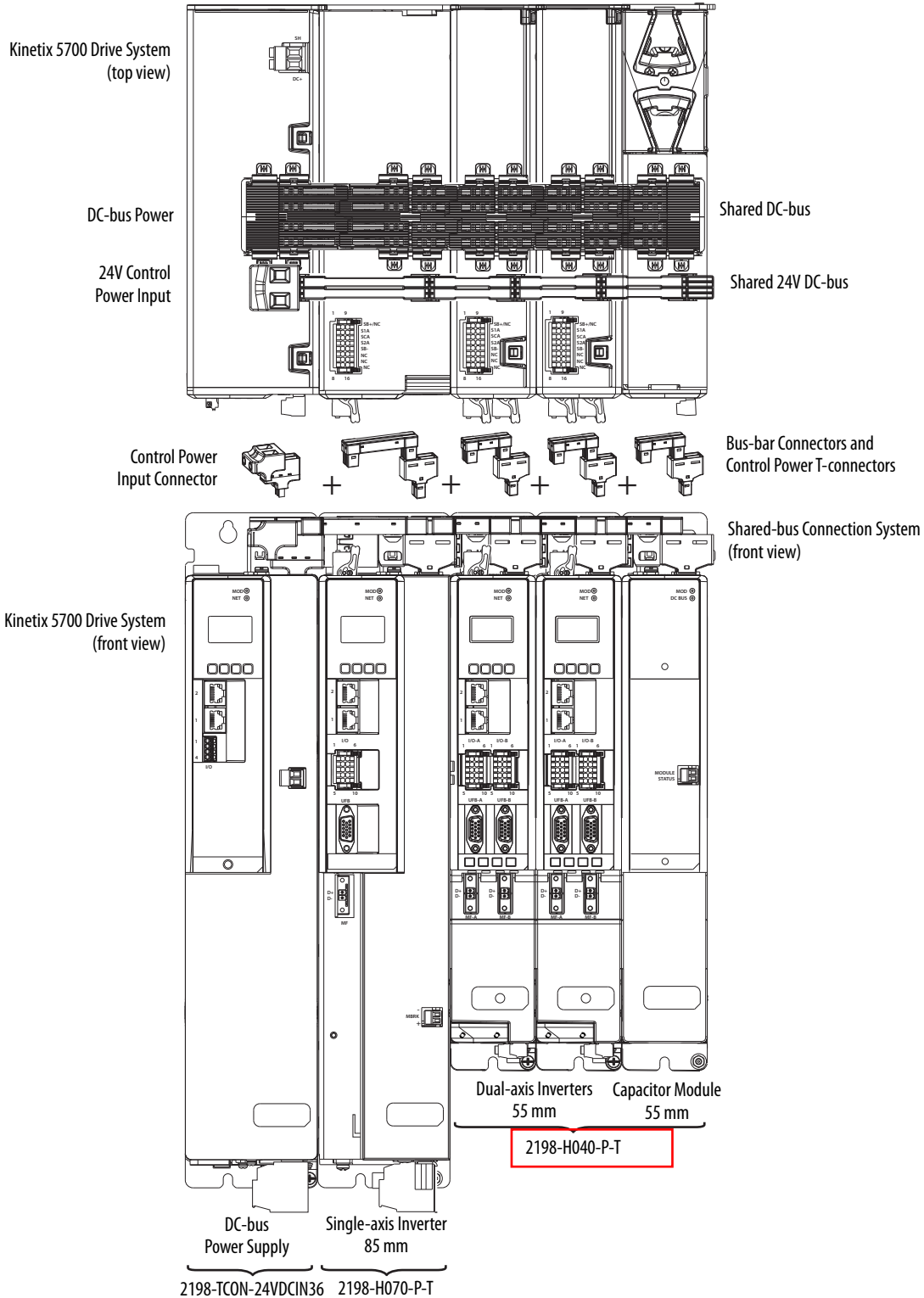

Multiple 24V shared-bus input wiring connectors can be used in a high axis-count system. If the 40 A shared-bus current rating is exceeded, you can add another connector at any point in the cluster. 2198-S263-ERSx and 2198-S312-ERSx drives and 2198-RP263 and 2198-RP312 bus supplies use the 2198T-W25K-P-IN input wiring connector. All other modules use the 2198-TCON-24VDCIN36 input wiring connector. Both wiring connectors accept up to 10 mm² (6 AWG) wire. The CP connectors that are included with each module accept up to 10 mm² (12 AWG) or 6 mm² (10 AWG), so the shared-bus input wiring connectors can provide the means to use larger gauge conductors for reduced voltage drop on long wire runs. Refer to the Kinetix 5700 Servo Drives User Manual, publication [2198-UM002](#), for system sizing information.

In this regenerative bus supply example, 24V control power is applied to two input connectors. The first 24V input connector (catalog number 2198-TCON-24VDCIN36) plugs into the module that is positioned on the far left. The second input connector (catalog number 2198T-W25K-P-IN) was added because bus-bars to span across the regenerative bus supply are not available.

Shared 24V DC Installation Example 2

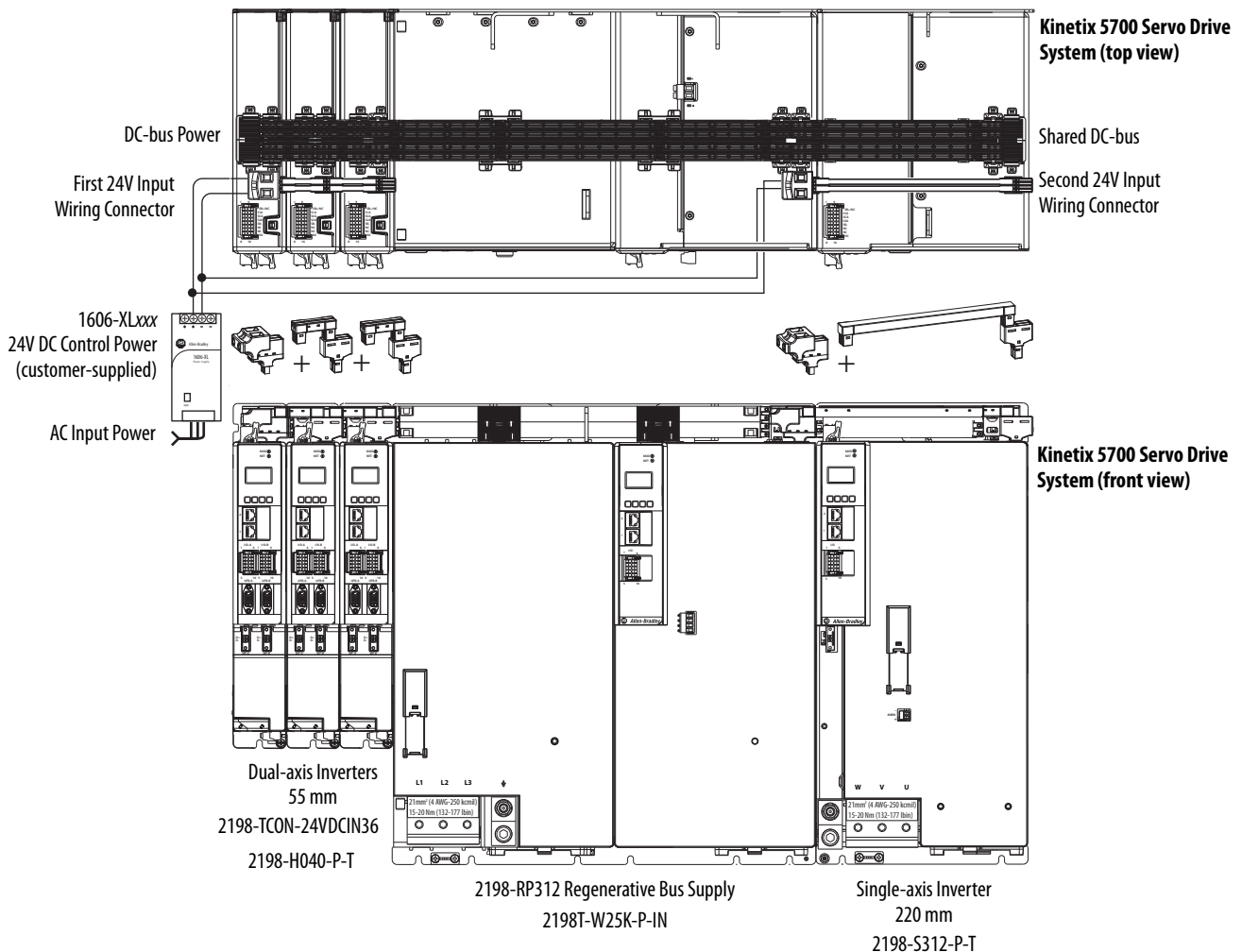

2090-Series Single Motor Cable Overview

These cables apply to Kinetix VP rotary motors and linear actuators. When using single cables, system performance of a typical system applies with motor ambient at 40 °C (104 °F) and drive ambient at 50 °C (122 °F). For maximum motor-cable lengths with Kinetix 5700 drives, see the Kinetix 5700 Servo Drives User Manual, publication [2198-UM002](#).

IMPORTANT Because of the unique characteristics of single cable technology, building your own cables, using field modified Rockwell Automation® factory-delivered cable, or using third-party cables with Kinetix VPL, VPF, VPH, VPS, and VPC-Bxxxxx-Q servo motors and Kinetix VPAR electric cylinders is not an option.

Single Motor Cable Descriptions (flying leads)

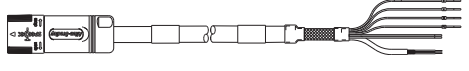
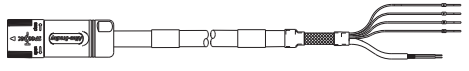
Cable Cat. No.	Description	Cable Configuration		Motor Connector
		Motor End	Drive End	
2090-CSBM1DG-xxxAxx 2090-CSBM1DG-xxxFxx	<ul style="list-style-type: none"> • Drive-end flying-leads (DG) • Power/feedback/brake wires (SB) • Standard, non-flex (AA, VA) • Continuous-flex (AF, LF) 			SpeedTec DIN
2090-CSWM1DG-xxxAxx	<ul style="list-style-type: none"> • Drive-end flying-leads (DG) • Power/feedback wires only (SW) • Standard, non-flex (AA, VA) 			

2090-CSxM1DG cable conductors have flying-leads and lead preparation that is designed for either Kinetix 5500 or Kinetix 5700 servo drives. No on-site lead preparation is required; however, 2090-CSxM1DG cable leads are long enough to accommodate either drive family. 2090-CSxM1DE cables include the 2198-KITCON-DSL connector kit.

Single Motor Cable Descriptions (feedback connector kit)

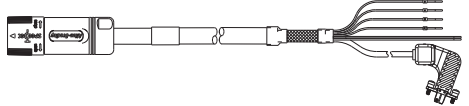
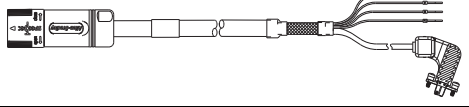
Cable Cat. No.	Description	Cable Configuration		Motor Connector
		Motor End	Drive End	
2090-CSBM1DE-xxxAxx 2090-CSBM1DE-xxxFxx	<ul style="list-style-type: none"> • Drive-end connector kit (DE) • Power/feedback/brake wires (SB) • Standard, non-flex (AA, VA) • Continuous-flex (AF, LF) 			SpeedTec DIN
2090-CSWM1DE-xxxAxx	<ul style="list-style-type: none"> • Drive-end connector kit (DE) • Power/feedback wires only (SW) • Standard, non-flex (AA, VA) 			

Optimize the placement of your continuous-flex application with extension cables. Use standard (non-flex) extension cables to cover distances that are outside of the continuous-flex application. For example, attach a standard (non-flex) extension cable to the motor and use a continuous-flex flying lead cable for applications that require flexing closer to the drive. The stationary portion of cable can stay routed permanently throughout the application while the continuous-flex cable can be placed in the location that may need maintenance, changeovers, replacement, or general services.

The IP rating for extension cables is consistent with the motor/actuator and cable combination they are extending. Extension cables are available with 18, 14, 10, 8, and 6 AWG power conductors and lengths up to 30 m (98.4 ft).

Single Extension Cable Descriptions

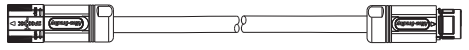
Cable Cat. No.	Description	Cable Configuration		Motor Connector
		Motor End	Drive End	
2090-CSBM1E1-xxVAxx 2090-CSBM1E1-xxxFxx	<ul style="list-style-type: none"> Drive-end (male) connector, extension (E1) ⁽¹⁾ Motor-end SpeedTec DIN cable plug (M1) Standard, non-flex (VA) Continuous-flex (AF, LF) 			SpeedTec DIN



(1) SpeedTec DIN connector (motor end) and male connector for extending SpeedTec DIN cable.

Refer to the Kinetix Motion Accessories Technical Data, publication [KNX-TD004](#), for cable specifications.

2090-Series Motor Power/Brake and Feedback Cables Overview



These cables apply to all other Allen-Bradley compatible rotary motors including Kinetix MP, HPK, RDB, and VPC-Bxxxxx-S, VPC-B3004x-M, and VPC-Bxxxxx-Y rotary motors. They also apply to compatible LDAT-Series and Kinetix MPAR linear actuators. For maximum motor-cable lengths with Kinetix 5700 drives, see the Kinetix 5700 Servo Drives User Manual, publication [2198-UM002](#).

Feedback Cable Descriptions (standard, non-flex)

Standard Cable Cat. No.	Description	Cable Configuration		Motor/Actuator Connector
		Motor/Actuator End	Drive End	
2090-CFBM7DF-CEAxx	<ul style="list-style-type: none"> Drive-end flying-leads (DF) High-resolution or resolver applications (CE) 			SpeedTec DIN (M7)
2090-CFBM4E2-CATR	<ul style="list-style-type: none"> Drive-end bayonet (E2), transition (TR) cable ⁽¹⁾ Motor-end threaded DIN (M4) All feedback types (CA) 			Threaded DIN (M4)

(1) Threaded DIN connector (motor end) and bayonet connector for 2090-XXNFMP-Sxx cable.

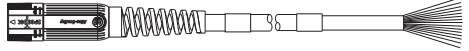

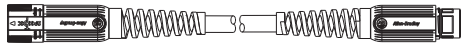
Feedback Cable Descriptions (continuous-flex)

Continuous-flex Cable Cat. No.	Description	Cable Configuration		Motor/Actuator Connector
		Motor/Actuator End	Drive End	
2090-CFBM7DF-CDAFxx	<ul style="list-style-type: none"> Drive-end flying-leads (DF) High-resolution or incremental applications (CD) 			SpeedTec DIN (M7)
2090-CFBM7E7-CDAFxx	<ul style="list-style-type: none"> Drive-end flying-leads (DF) High-resolution or resolver applications (CE) 			
2090-CFBM7E7-CEAFxx	<ul style="list-style-type: none"> Drive-end (male) connector, extension (E7) ⁽¹⁾ Motor-end SpeedTec DIN cable plug (M7) 			

(1) SpeedTec DIN connector (motor end) and male connector for extending SpeedTec or threaded DIN cable.

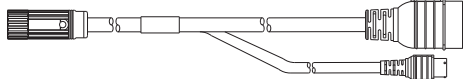
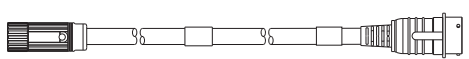

Motor-end cable connector kits, for use when building your own cables are also available. Refer to the Kinetix Motion Accessories Technical Data, publication [KNX-TD004](#), for more information.

Power/Brake Cable Descriptions (standard, non-flex)

Standard Cable Cat. No.	Description	Cable Configuration		Motor/Actuator Connector
		Motor/Actuator End	Drive End	
2090-CPBM7DF-xxAAxx	<ul style="list-style-type: none"> • Drive-end flying-leads (DF) • Power/brake wires (PB) 			SpeedTec DIN (M7)
2090-CPWM7DF-xxAAxx	<ul style="list-style-type: none"> • Drive-end flying-leads (DF) • Power wires only (PW) 			
2090-CPBM4E2-xxTR	<ul style="list-style-type: none"> • Drive-end bayonet (E2), transition (TR) cable ⁽¹⁾ • Motor-end threaded DIN (M4) • Power/brake wires (PB) 			Threaded DIN (M4)
2090-CPWM4E2-xxTR	<ul style="list-style-type: none"> • Drive-end bayonet (E2), transition (TR) cable ⁽¹⁾ • Motor-end threaded DIN (M4) • Power wires only (PW) 			

(1) Threaded DIN connector (motor end) and bayonet connector for 2090-XXNFMP-Sxx cable.

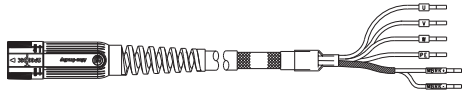
Power/Brake Cable Descriptions (continuous-flex)

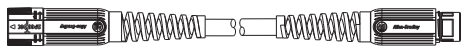
Continuous-flex Cable Cat. No.	Description	Cable Configuration		Motor/Actuator Connector
		Motor/Actuator End	Drive End	
2090-CPBM7DF-xxAFxx	<ul style="list-style-type: none"> • Drive-end flying-leads (DF) • Power/brake wires (PB) 			SpeedTec DIN (M7)
2090-CPWM7DF-xxAFxx	<ul style="list-style-type: none"> • Drive-end flying-leads (DF) • Power wires only (PW) 			
2090-CPBM7E7-xxAFxx	<ul style="list-style-type: none"> • Drive-end (male) connector, extension (E7) ⁽¹⁾ • Motor-end SpeedTec DIN cable plug (M7) 			

(1) SpeedTec DIN connector (motor end) and male connector for extending SpeedTec or threaded DIN cable.

Refer to the Kinetix Motion Accessories Technical Data, publication [KNX-TD004](#), for cable specifications.

Kinetix 5700 (400V-class) Drives with Kinetix VPL Low-inertia Motors

This section provides system combination information for the Kinetix 5700 drives (with 400 and 480V, nominal input) when matched with Kinetix VPL (400V-class) servo motors. Single-cable catalog numbers, system performance specifications, and the optimum torque/speed curves are included.

Kinetix VPL Motor Cable Combinations

Rotary Motor (400V-class) Cat. No.	Single Motor Cable ⁽¹⁾	Feedback Type
VPL-B0631x, VPL-B0632x, VPL-B0633x	2090-CSBM1Dx-18xAxx or 2090-CSWM1Dx-18xAxx (standard, non-flex) 2090-CSBM1Dx-18xFxx (continuous-flex)	Single-turn or Absolute, Multi-turn Digital Encoder • SIL 2/PLd Rated • Hiperface DSL Protocol
VPL-B0751M, VPL-B0752x, VPL-B0753x		
VPL-B1001M, VPL-B1002E, VPL-B1003C, VPL-B1003F		
VPL-B1152C, VPL-B1153E		
VPL-B1002M, VPL-B1003T	2090-CSBM1Dx-14xAxx or 2090-CSWM1Dx-14xAxx (standard, non-flex) 2090-CSBM1Dx-14xFxx (continuous-flex)	
VPL-B1152F, VPL-B1152T, VPL-B1153F		
VPL-B1303x, VPL-B1304x, VPL-B1306x		
VPL-B1651C, VPL-B1651F, VPL-B1652C, VPL-B1652F, VPL-B1653C, VPL-B1653D, VPL-B1654B	2090-CSBM1Dx-10VAxx (standard, non-flex) 2090-CSBM1Dx-10xFxx (continuous-flex)	
VPL-B1654D		

(1) Use 2090-CSxM1DE or 2090-CSxM1DG cables. Cable length xx is in meters, 01 (3.3) . . . 50 (164) in 1.0 m (3.3 ft) increments. For information on maximum cable lengths see Kinetix 5700 Servo Drives User Manual, publication [2198-UM002](#). Refer to the Kinetix Motion Accessories Technical Data, publication [KNX-TD004](#), for cable specifications. For cable configuration illustrations and feature descriptions, by catalog number, refer to 2090-Series Single Motor Cable Overview beginning on [page 18](#).

Kinetix VPL Motor Performance Specifications with Kinetix 5700 (400V-class) Drives

Rotary Motor Cat. No.	Rated Speed rpm	Maximum Speed rpm	System Continuous Stall Current A (0-pk)	System Continuous Stall Torque N·m (lb·in)	System Peak Stall Current A 0-pk	System Peak Stall Torque N·m (lb·in)	Motor Rated Output kW (Hp)	Kinetix 5700 Drives (480V AC input)
VPL-B0631T	8000	8000	1.20	0.46 (4.0)	4.20	1.33 (12.0)	0.31 (0.42)	2198-D006-ERSx
VPL-B0631U	8000	8000	1.92	0.46 (4.0)	6.48	1.33 (12.0)	0.31 (0.42)	2198-D006-ERSx
VPL-B0632F	4600	4600	1.20	0.93 (8.0)	4.20	2.69 (24.0)	0.37 (0.50)	2198-D006-ERSx
VPL-B0632T	8000	8000	2.55	0.93 (8.0)	8.75	2.69 (24.0)	0.54 (0.72)	2198-D006-ERSx
VPL-B0633M	6500	6700	2.50	1.27 (11.0)	8.75	4.09 (36.0)	0.57 (0.76)	2198-D006-ERSx
VPL-B0633T	6500	8000	3.52	1.27 (11.0)	8.80	2.87 (25.0)	0.57 (0.76)	2198-D006-ERSx
					12.60	4.09 (36.0)		2198-D012-ERSx
VPL-B0751M	8000	8000	2.90	1.01 (9.0)	8.80	2.20 (19.0)	0.54 (0.72)	2198-D006-ERSx
					9.12	2.27 (20.0)		2198-D012-ERSx
VPL-B0752E	4900	4900	2.70	1.61 (14.0)	8.80	4.10 (36.0)	0.67 (0.90)	2198-D006-ERSx
					9.45	4.39 (39.0)		2198-D012-ERSx
VPL-B0752F	7000	7000	3.80	1.61 (14.0)	13.30	4.39 (39.0)	0.80 (1.07)	2198-D012-ERSx
VPL-B0752M	8000	8000	4.90	1.61 (14.0)	17.60	4.10 (36.0)	0.81 (1.09)	2198-D012-ERSx
					18.90	4.39 (39.0)		2198-D020-ERSx
VPL-B0753E	4500	4500	3.80	2.28 (20.0)	13.30	7.35 (65.0)	0.81 (1.09)	2198-D012-ERSx
VPL-B0753F	4500	6600	4.09	2.16 (19.0)	17.60	6.55 (58.0)	0.65 (0.87)	2198-D012-ERSx
					18.90	7.02 (62.0)		2198-D020-ERSx
VPL-B0753M	6000	8000	6.12	2.28 (20.0)	17.60	5.13 (45.0)	0.82 (1.10)	2198-D012-ERSx
					25.34	7.35 (65.0)		2198-D020-ERSx

Kinetix VPL Motor Performance Specifications with Kinetix 5700 (400V-class) Drives (continued)

Rotary Motor Cat. No.	Rated Speed rpm	Maximum Speed rpm	System Continuous Stall Current A (0-pk)	System Continuous Stall Torque N-m (lb-in)	System Peak Stall Current A 0-pk	System Peak Stall Torque N-m (lb-in)	Motor Rated Output kW (Hp)	Kinetix 5700 Drives (480V AC input)
VPL-B1001M	6000	6000	3.61	1.93 (17.0)	8.80	3.22 (28.0)	1.14 (1.53)	2198-D006-ERSx
					10.38	3.78 (33.0)		2198-D012-ERSx
VPL-B1002E	3300	3300	3.44	3.39 (30.0)	8.80	6.47 (57.0)	1.12 (1.50)	2198-D006-ERSx
					10.69	7.82 (69.0)		2198-D012-ERSx
VPL-B1002M	6000	6000	6.24	3.39 (30.0)	17.60	6.80 (60.0)	1.86 (2.49)	2198-D012-ERSx
					20.33	7.82 (69.0)		2198-D020-ERSx
VPL-B1003C	2500	2500	3.41	4.18 (37.0)	8.80	9.29 (82.0)	0.96 (1.29)	2198-D006-ERSx
					10.61	11.15 (99.0)		2198-D012-ERSx
VPL-B1003F	4750	4750	6.14	4.18 (37.0)	17.60	9.76 (86.0)	1.65 (2.21)	2198-D012-ERSx
					20.20	11.15 (99.0)		2198-D020-ERSx
VPL-B1003T	7000	7000	9.58	4.18 (37.0)	28.20	11.0 (97.4)	1.77 (2.37)	2198-D020-ERSx
					28.80	11.15 (99.0)		2198-D032-ERSx
VPL-B1152C	2250	2250	3.13	5.10 (45.0)	8.80	10.80 (95.0)	1.06 (1.42)	2198-D006-ERSx
					10.74	13.12 (116)		2198-D012-ERSx
VPL-B1152F	4000	4500	6.17	5.10 (45.0)	17.60	10.95 (97.0)	1.40 (1.88)	2198-D012-ERSx
					21.19	13.12 (116)		2198-D020-ERSx
VPL-B1152T	6500	6500	10.81	5.08 (45.0)	28.20	12.14 (107)	2.29 (3.07)	2198-D020-ERSx
					32.10	13.12 (116)		2198-D032-ERSx
VPL-B1153E	3200	3200	6.13	6.55 (58.0)	17.60	16.85 (149)	1.75 (2.35)	2198-D012-ERSx
					21.33	20.33 (180)		2198-D020-ERSx
VPL-B1153F	5000	5000	8.88	6.55 (58.0)	28.20	18.30 (162)	2.30 (3.08)	2198-D020-ERSx
					33.0	20.33 (180)		2198-D032-ERSx
VPL-B1303C	2250	2250	6.30	8.80 (78.0)	17.60	19.83 (175)	1.83 (2.45)	2198-D012-ERSx
					18.47	20.72 (183)		2198-D020-ERSx
VPL-B1303F	4000	4000	10.10	8.80 (78.0)	28.20	19.85 (175)	2.82 (3.78)	2198-D020-ERSx
					31.0	20.72 (183)		2198-D032-ERSx
VPL-B1304C	2150	2150	7.0	10.29 (91.0)	17.60	22.55 (199)	1.75 (2.35)	2198-D012-ERSx
					22.3	28.45 (252)		2198-D020-ERSx
VPL-B1304E	3500	3500	9.44	10.29 (91.0)	28.20	25.03 (221)	2.82 (3.78)	2198-D020-ERSx
					33.76	28.45 (252)		2198-D032-ERSx
VPL-B1306C	2500	2500	10.80	13.38 (118)	28.20	31.21 (276)	2.46 (3.30)	2198-D020-ERSx
					32.94	34.62 (306)		2198-D032-ERSx
VPL-B1306F	4250	4250	14.78	13.38 (118)	45.90	28.50 (252)	2.95 (3.95)	2198-D032-ERSx
					55.83	34.62 (306)		2198-D057-ERSx
VPL-B1651C	2750	2750	10.21	11.50 (102)	28.20	21.68 (192)	2.32 (3.11)	2198-D020-ERSx
					29.29	22.45 (199)		2198-D032-ERSx
VPL-B1651F	4750	4750	17.60	11.43 (101)	45.90	18.02 (159)	4.38 (5.87)	2198-D032-ERSx
					57.27	22.45 (199)		2198-D057-ERSx
VPL-B1652C	2700	2700	16.0	19.40 (172)	45.90	44.78 (396)	4.18 (5.60)	2198-D032-ERSx
					49.88	48.60 (430)		2198-D057-ERSx
VPL-B1652F	4000	4000	18.60	17.60 (156)	60.00	48.60 (430)	4.77 (6.40)	2198-D057-ERSx

Kinetix VPL Motor Performance Specifications with Kinetix 5700 (400V-class) Drives (continued)

Rotary Motor Cat. No.	Rated Speed rpm	Maximum Speed rpm	System Continuous Stall Current A (0-pk)	System Continuous Stall Torque N·m (lb·in)	System Peak Stall Current A 0-pk	System Peak Stall Torque N·m (lb·in)	Motor Rated Output kW (Hp)	Kinetix 5700 Drives (480V AC input)
VPL-B1653C	2300	2300	17.75	25.76 (228)	45.90	55.14 (488)	4.38 (5.87)	2198-D032-ERSx
					55.60	66.70 (590)		2198-D057-ERSx
VPL-B1653D	3000	3000	18.60	24.20 (214)	68.00	67.80 (600)	5.50 (7.30)	2198-D057-ERSx
VPL-B1654B	1850	1850	15.54	32.97 (292)	45.90	65.38 (578)	5.55 (7.44)	2198-D032-ERSx
					55.75	79.30 (702)		2198-D057-ERSx
VPL-B1654D	3000	3000	24.47	32.0 (283)	81.30	75.30 (666)	7.16 (9.60)	2198-D057-ERSx

Performance specification data and curves reflect nominal system performance of a typical system with the motor ambient at 40 °C (104 °F), drive ambient at 50 °C (122 °F), and rated line voltage. For additional information on ambient and line conditions, refer to Motion Analyzer software.

Kinetix 5700 (400V-class) Drives/Kinetix VPL Servo Motor Curves

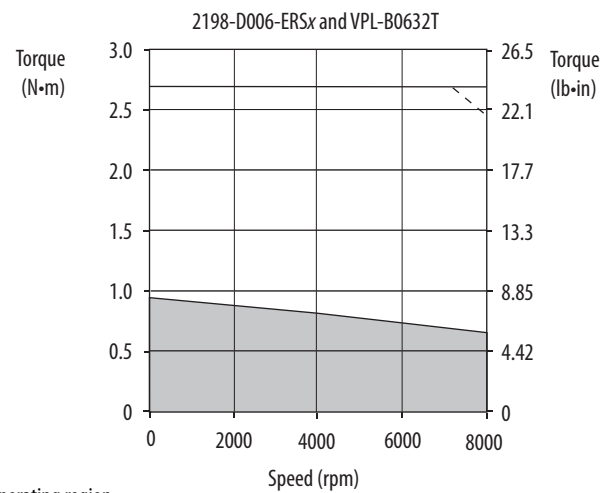
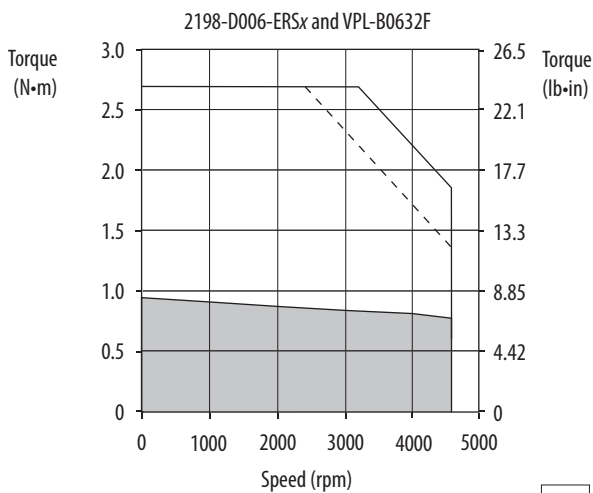
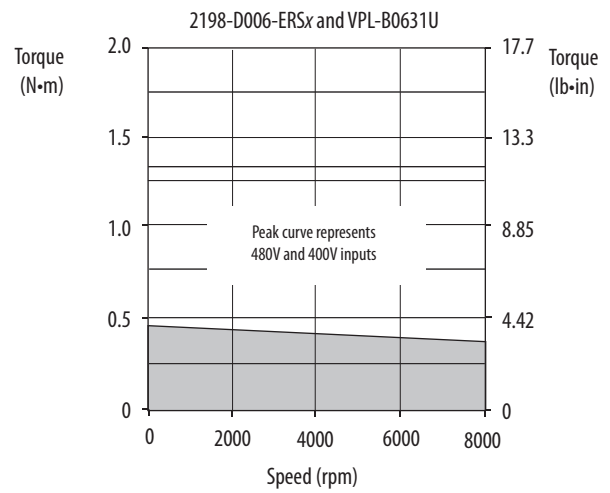
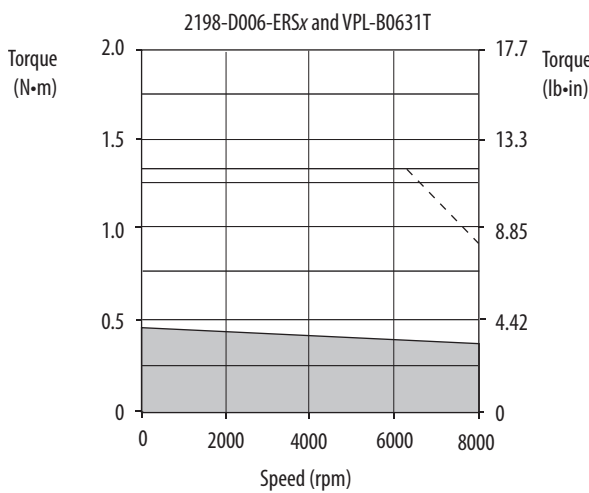

- = Intermittent operating region
- = Continuous operating region
- = Drive operation with 400V AC rms input voltage

Kinetix 5700 (400V-class) Drives/Kinetix VPL Servo Motor Curves (continued)

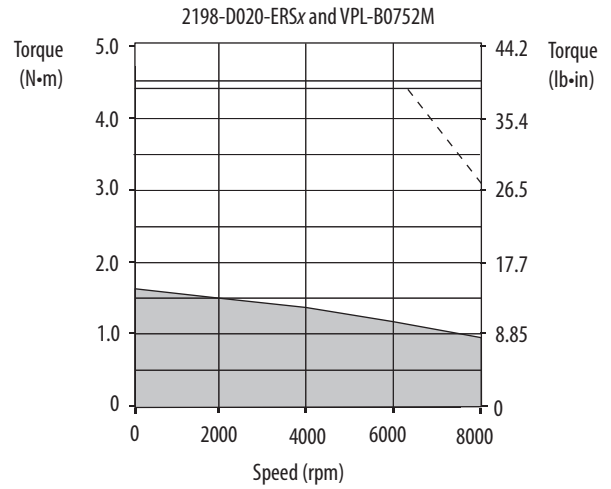
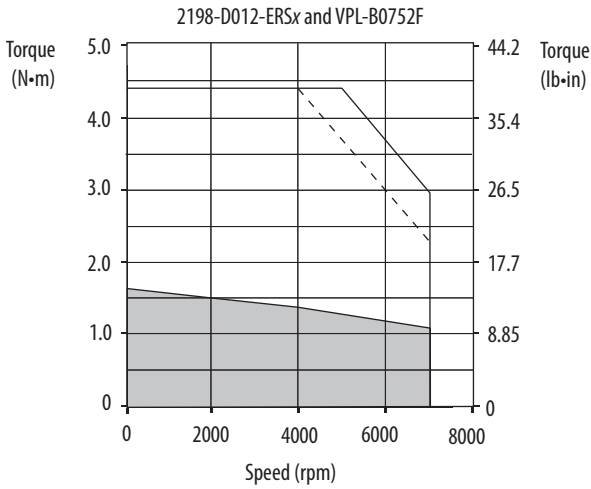
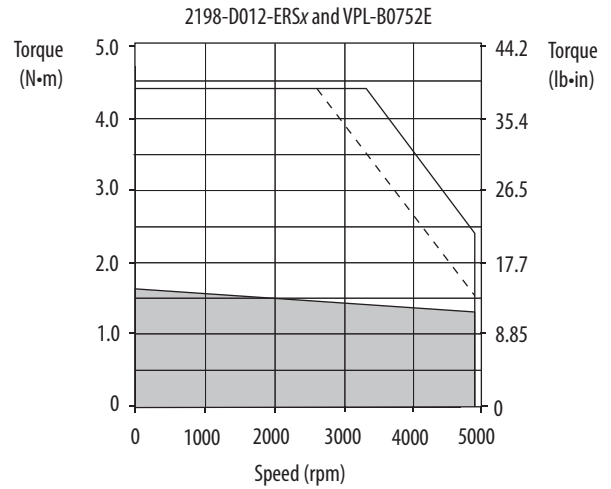
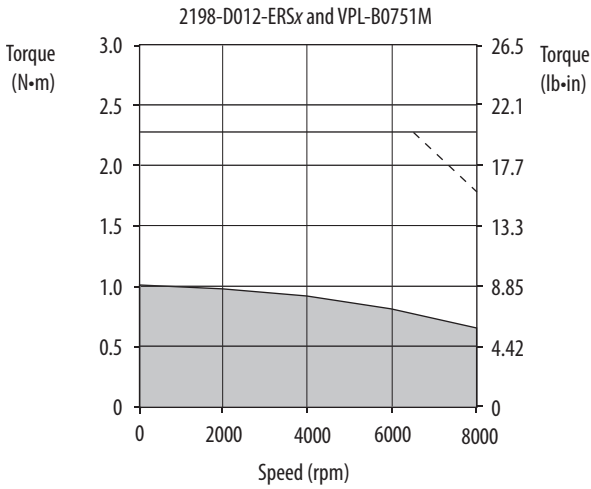
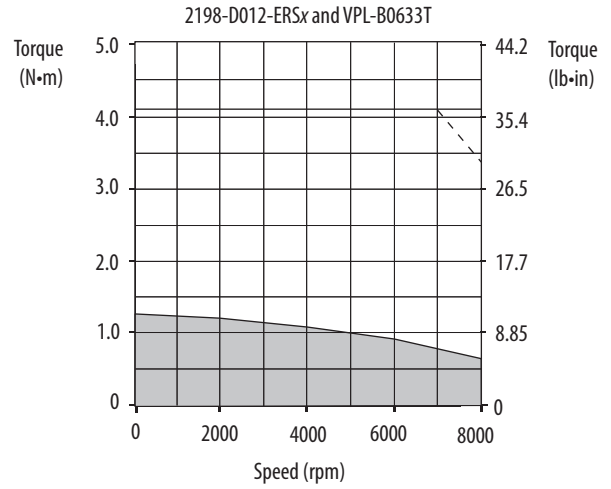
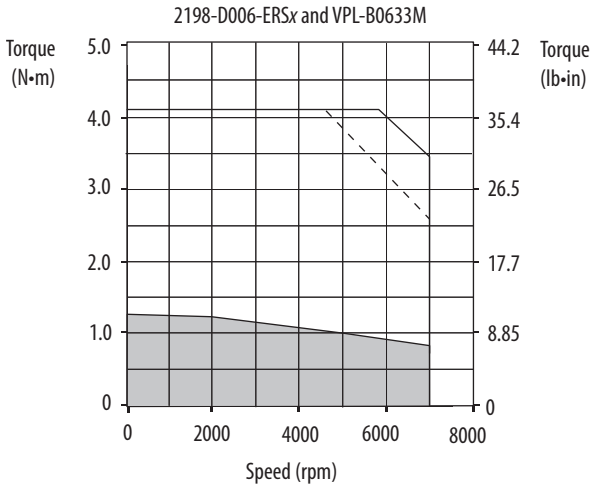

= Intermittent operating region
 = Continuous operating region
 = Drive operation with 400V AC rms input voltage

Kinetix 5700 (400V-class) Drives/Kinetix VPL Servo Motor Curves (continued)

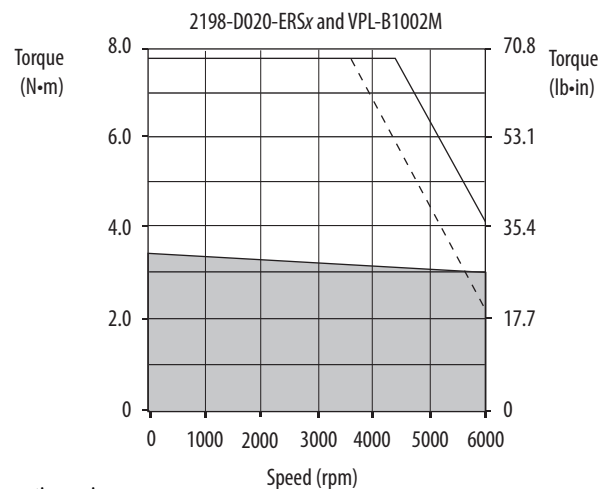
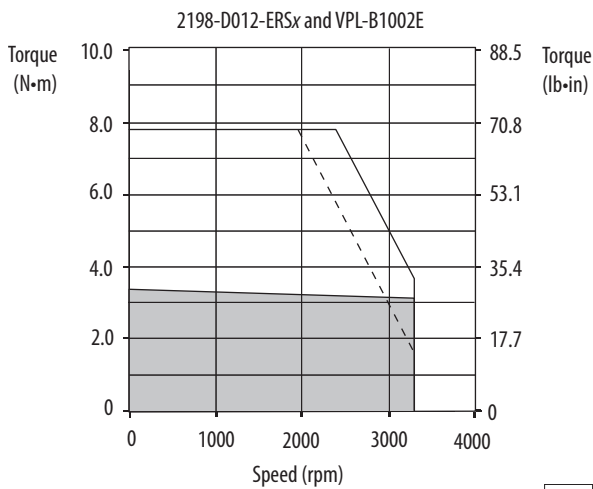
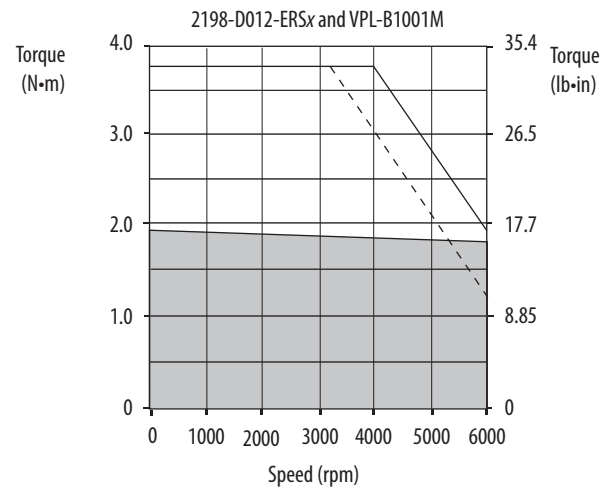
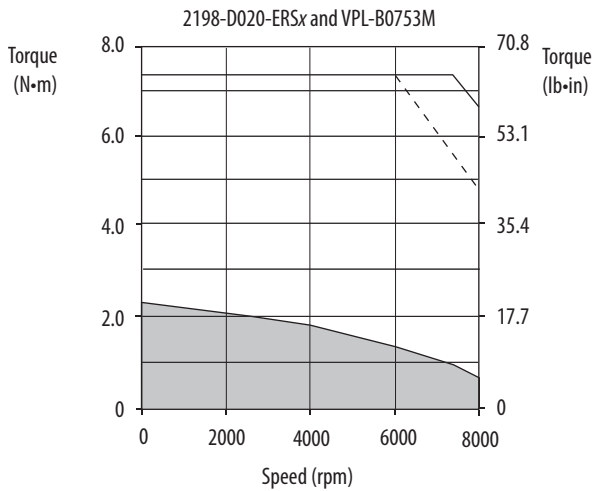
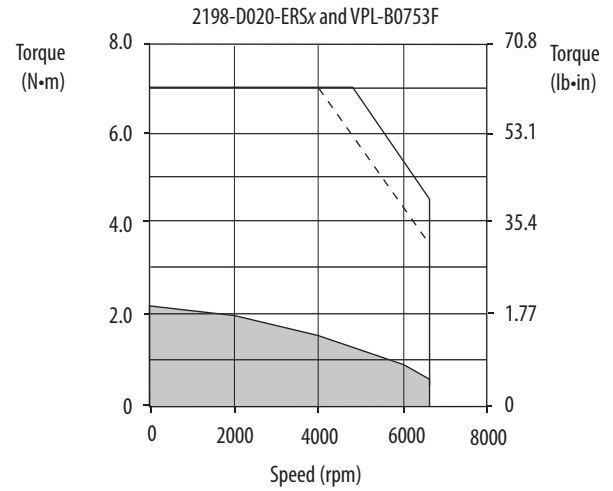
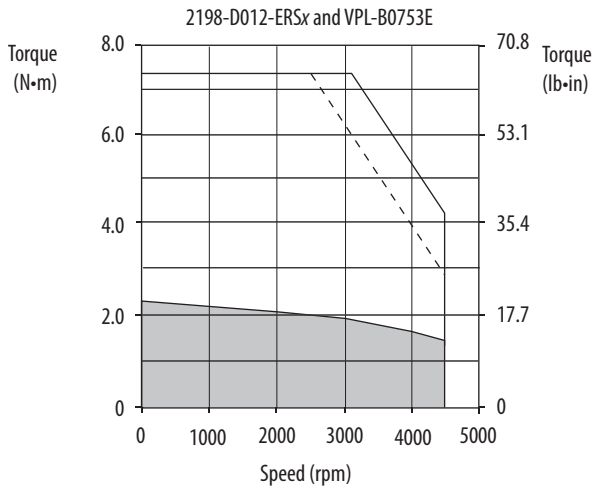

- = Intermittent operating region
- = Continuous operating region
- = Drive operation with 400V AC rms input voltage

Kinetix 5700 (400V-class) Drives/Kinetix VPL Servo Motor Curves (continued)

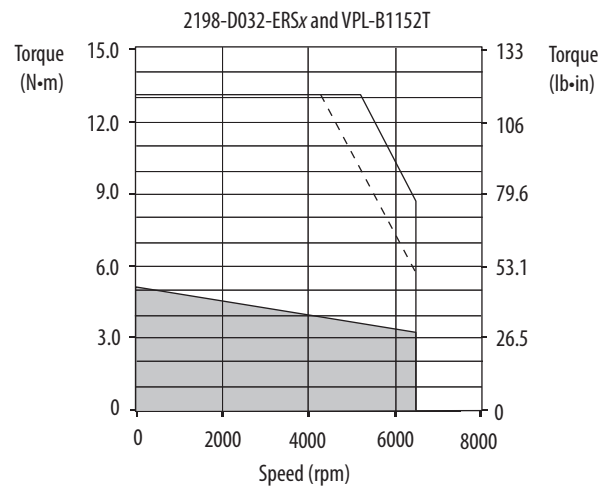
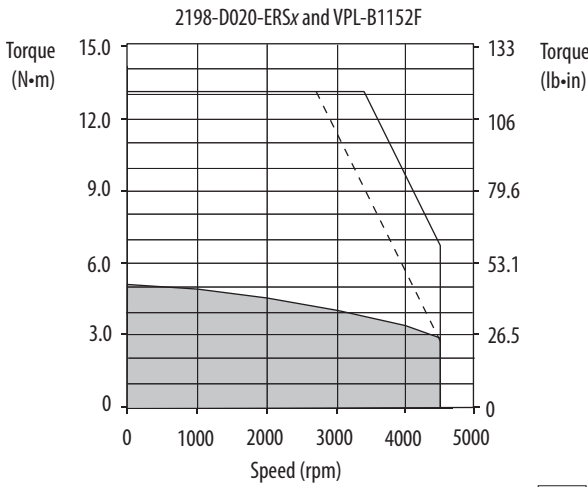
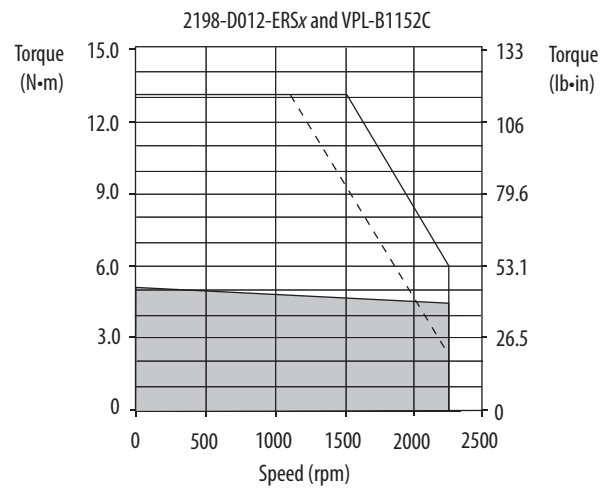
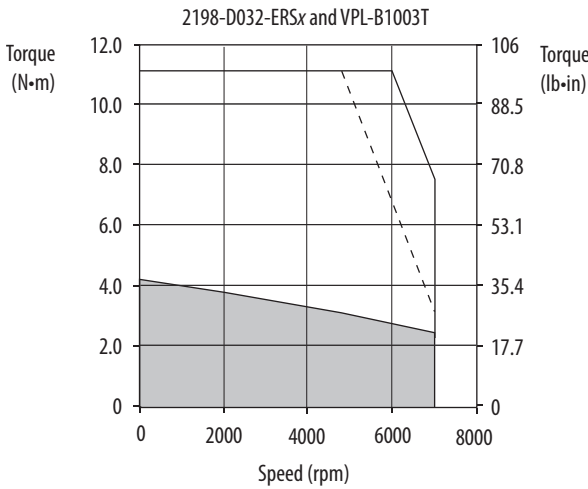
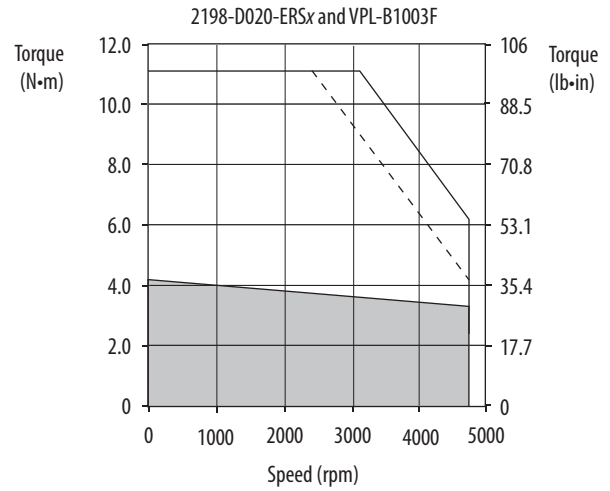
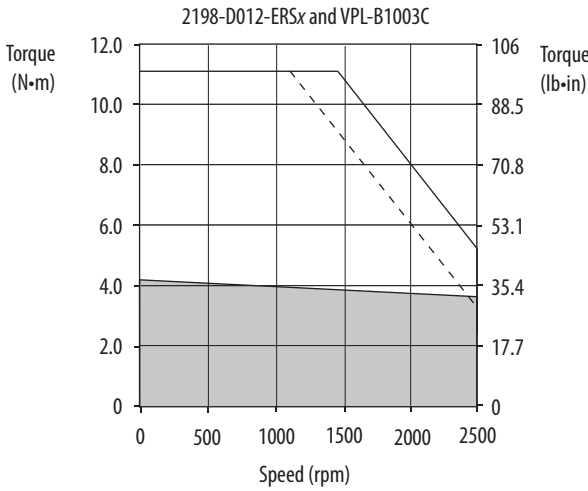

- = Intermittent operating region
- = Continuous operating region
- = Drive operation with 400V AC rms input voltage

Kinetix 5700 (400V-class) Drives/Kinetix VPL Servo Motor Curves (continued)

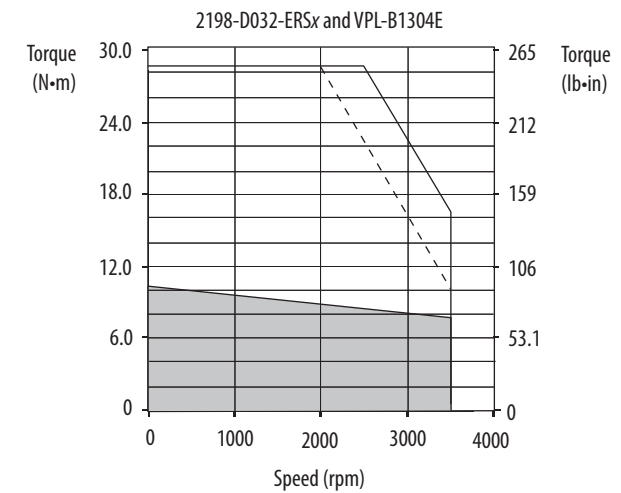
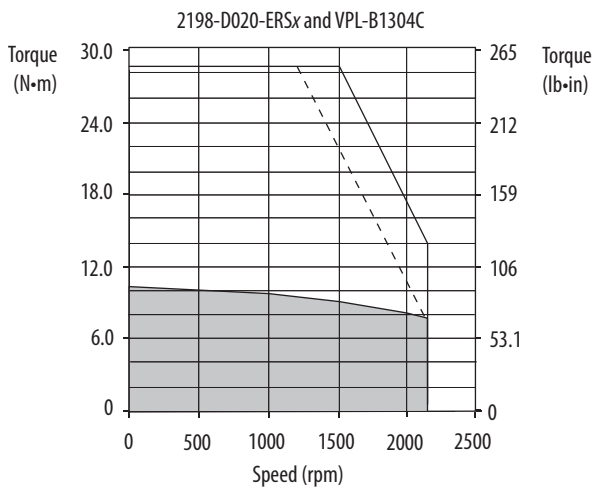
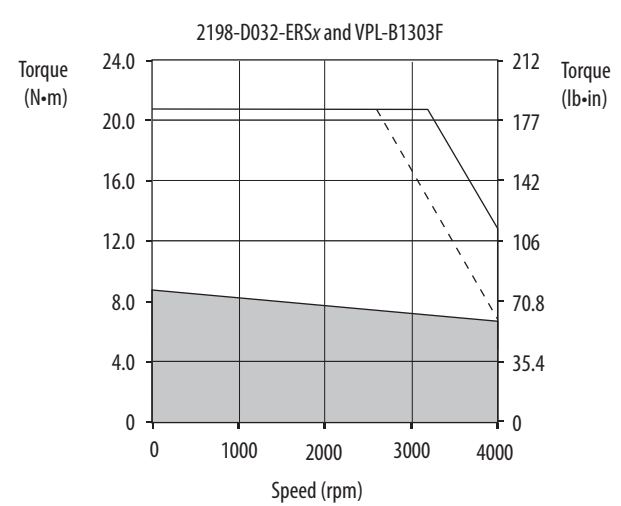
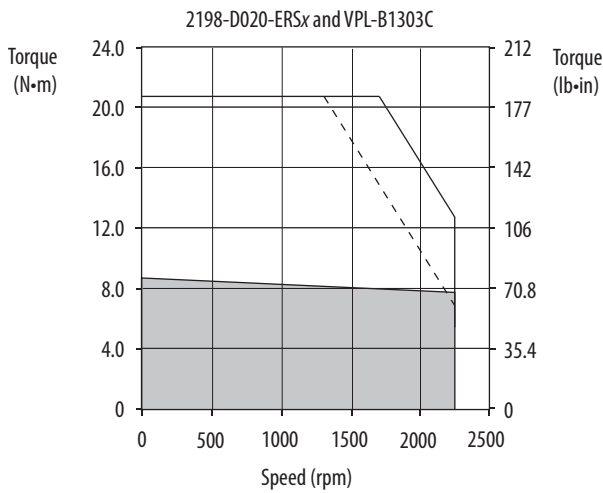
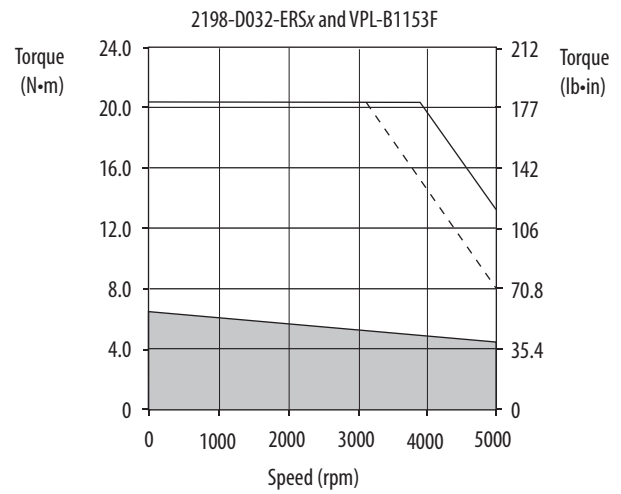
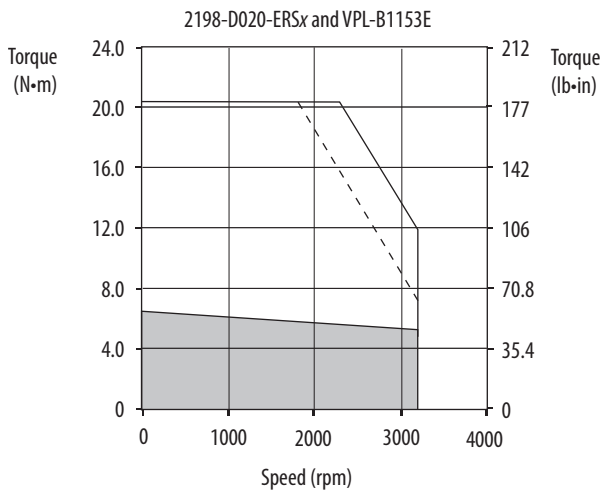

- = Intermittent operating region
- = Continuous operating region
- = Drive operation with 400V AC rms input voltage

Kinetix 5700 (400V-class) Drives/Kinetix VPL Servo Motor Curves (continued)

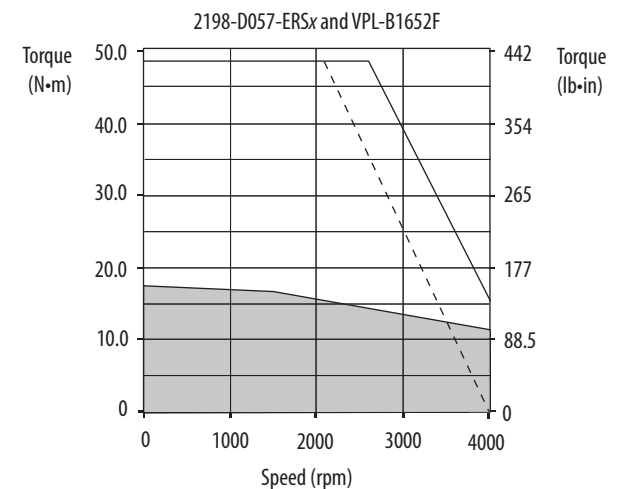
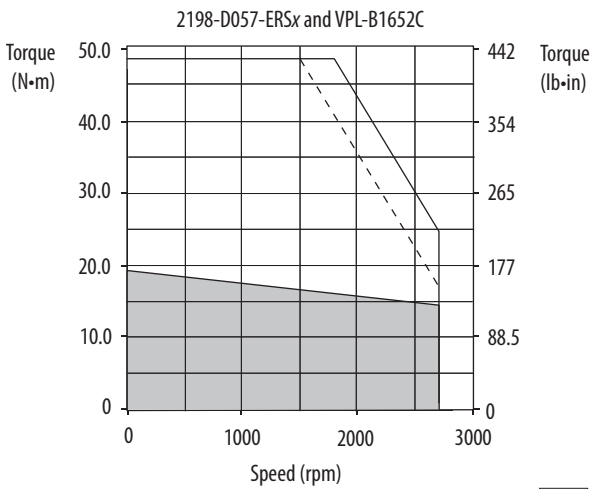
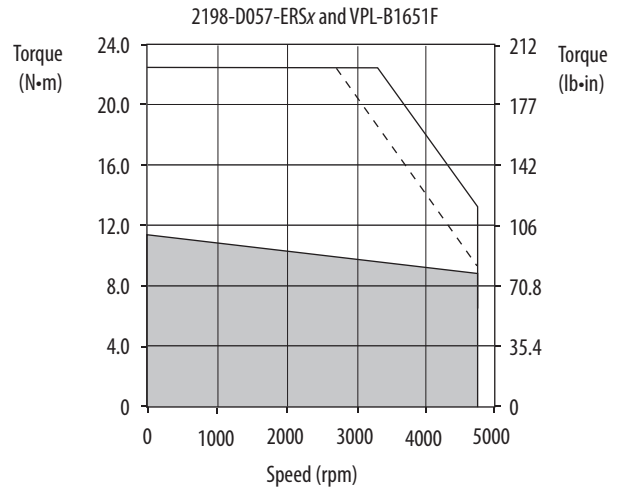
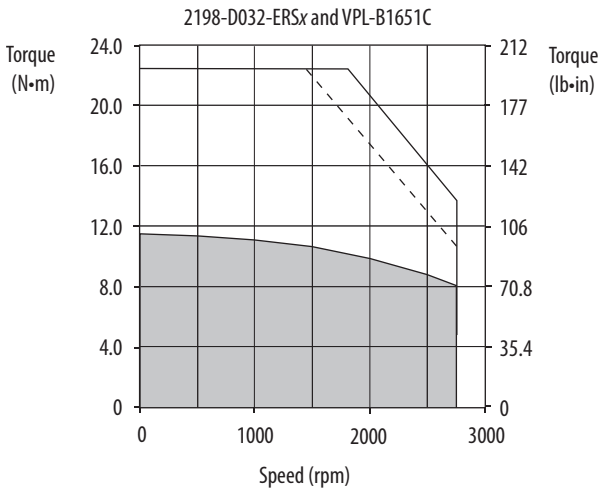
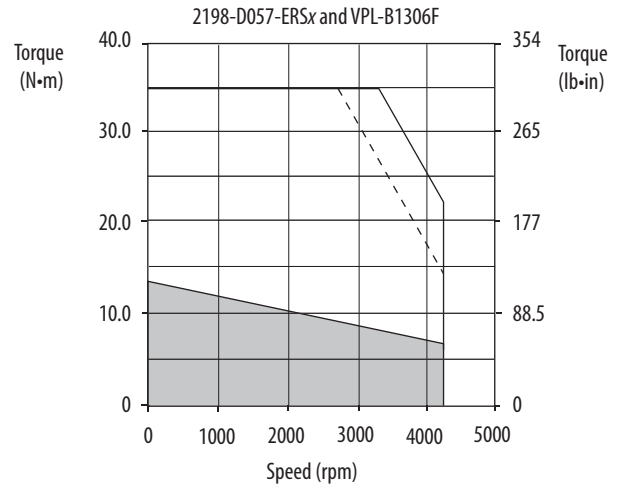
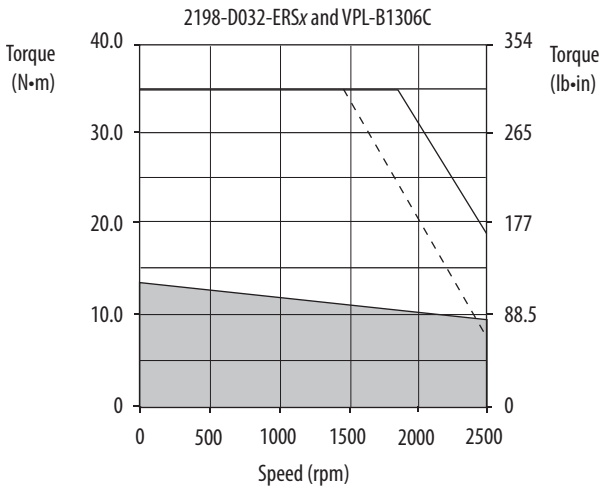

- = Intermittent operating region
- = Continuous operating region
- = Drive operation with 400V AC rms input voltage

Kinetix 5700 (400V-class) Drives/Kinetix VPL Servo Motor Curves (continued)

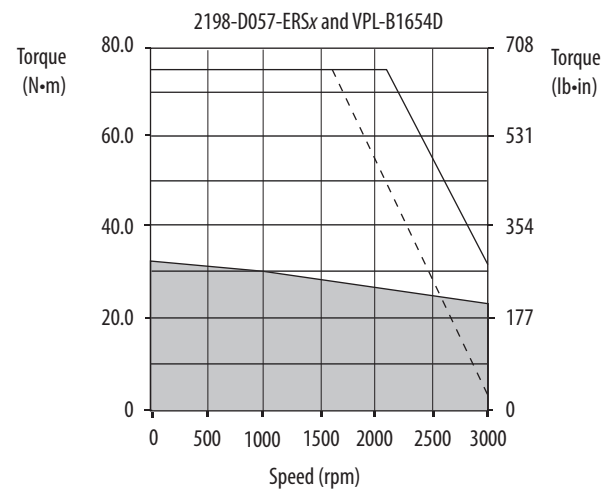
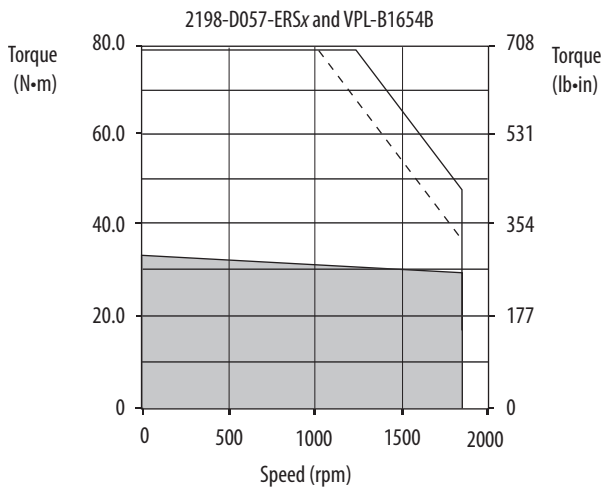
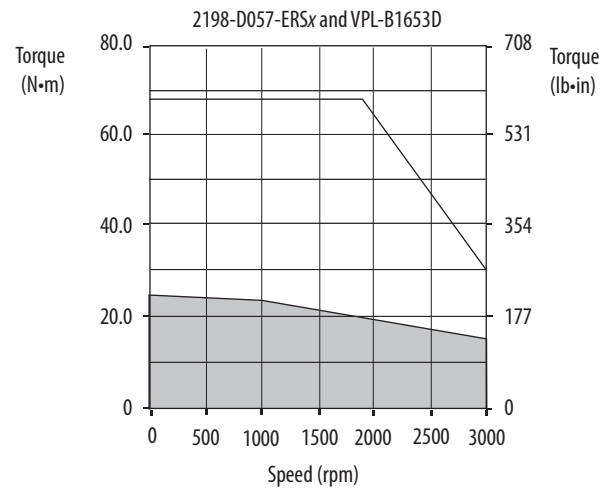
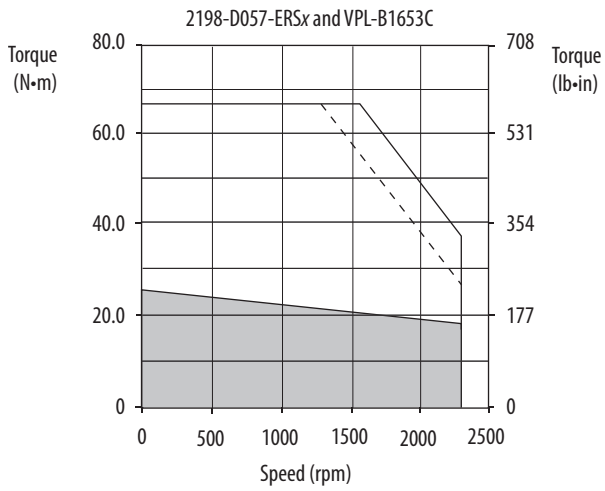

- = Intermittent operating region
- = Continuous operating region
- = Drive operation with 400V AC rms input voltage

Kinetix 5700 (400V-class) Drives with Kinetix VPC Continuous-duty Motors

This section provides system combination information for the Kinetix 5700 drives (with 400 and 480V, nominal input) when matched with Kinetix VPC (400V-class) servo motors. Motor cable catalog numbers, system performance specifications, and the optimum torque/speed curves, and power/speed curves are included. The torque/speed and power/speed curves that are provided reflect system performance with and without a cooling fan.

Single Motor-cable Combinations

Rotary Motor (400V-class) Cat. No.	Single Motor Cable ⁽¹⁾	Feedback Type
VPC-B1652x-Q, VPC-B1653x-Q	2090-CSBM1Dx-14xAxx or 2090-CSWM1Dx-14xAxx (standard, non-flex) 2090-CSBM1Dx-14xFxx (continuous-flex)	Absolute, Multi-turn Digital Encoder • SIL 2/PLd Rated • Hiperface DSL Protocol
VPC-B2153x-Q, VPC-B21549-Q		
VPC-B1654D-Q	2090-CSBM1Dx-10VAxx (standard, non-flex) 2090-CSBM1Dx-10xFxx (continuous-flex)	
VPC-B2154A-Q		
VPC-B30029-Q		
VPC-B2154B-Q, VPC-B2154D-Q, VPC-B2155B-Q, VPC-B2155D-Q	2090-CSBM1DE-08VAxx (standard, non-flex) 2090-CSBM1DE-08xFxx (continuous-flex)	
VPC-B3002A-Q, VPC-B30039-Q, VPC-B30049-Q		
VPC-B2156A-Q, VPC-B2156D-Q	2090-CSBM1DE-06VAxx (standard, non-flex) 2090-CSBM1DE-06xFxx (continuous-flex)	
VPC-B3003A-Q		

(1) Use 2090-CSxM1DE or 2090-CSxM1DG cables. Cable length xx is in meters, 01 (3.3) . . . 50 (164) in 1.0 m (3.3 ft) increments. For information on maximum cable lengths see Kinetix 5700 Servo Drives User Manual, publication [2198-UM002](#). Refer to the Kinetix Motion Accessories Technical Data, publication [KNX-TD004](#), for cable specifications. For cable configuration illustrations and feature descriptions, by catalog number, refer to 2090-Series Single Motor Cable Overview beginning on [page 18](#).

Motor Power/Brake and Feedback Cable Combinations

Rotary Motor (400V-class) Cat. No.	Motor Power/Brake Cable	Motor Feedback Cable ⁽¹⁾
VPC-B1652x-S/Y, VPC-B1653x-S/Y	2090-CPxM7DF-14AAxx (standard, non-flex) 2090-CPxM7DF-14AFxx (continuous-flex)	2090-CFBM7DF-CEAAxx ^{(2) (3)} (standard, non-flex) 2090-CFBM7DF-CEAFxx (continuous-flex) Absolute High-resolution Feedback
VPC-B2153x-S/Y, VPC-B21549-S/Y		
VPC-B1654D-S/Y	2090-CPxM7DF-10AAxx (standard, non-flex) 2090-CPxM7DF-10AFxx (continuous-flex)	
VPC-B2154A-S/Y		
VPC-B30029-S/Y		
VPC-B2154B-S/Y, VPC-B2154D-S/Y, VPC-B2155B-S/Y, VPC-B2155D-S/Y	2090-CPxM7DF-08AAxx (standard, non-flex) 2090-CPxM7DF-08AFxx (continuous-flex)	
VPC-B3002A-S/Y, VPC-B30039-S/Y, VPC-B30049-S/M/Y		
VPC-B2156A-S/Y, VPC-B2156D-S/Y	2090-CPBM7DF-06AAxx (standard, non-flex)	
VPC-B3003A-S/Y		
VPC-B3004A-S/M/Y, VPC-B3004B-S/M/Y, VPC-B3004D-S/M/Y	2090-CPBM7DF-04AAxx (standard, non-flex)	

(1) Use the 2198-K57CK-D15M feedback connector kit on the drive end. Refer to Determine What You Need on [page 10](#).

(2) Applies to Kinetix 5700 drives and VPC-Bxxxx-S motors (absolute, single-turn encoder) or VPC-B3004x-M motors (absolute, multi-turn encoder) with Hiperface protocol.

(3) Applies to Kinetix 5700 drives and VPC-Bxxxx-Y motors with absolute, multi-turn encoder (EnDat digital protocol).

Use 2090-CSxM1DE or 2090-CSxM1DG cables. Cable length xx is in meters, 01 (3.3) . . . 50 (164) in 1.0 m (3.3 ft) increments. For information on maximum cable lengths see Kinetix 5700 Servo Drives User Manual, publication [2198-UM002](#). Refer to the Kinetix Motion Accessories Technical Data, publication [KNX-TD004](#), for cable specifications. For cable configuration illustrations and feature descriptions, by catalog number, refer to 2090-Series Single Motor Cable Overview beginning on [page 18](#).

Kinetix VPC Motor Performance Specifications with Kinetix 5700 (400V-class) Drives

Motor Cat. No. ⁽¹⁾	Rated Speed rpm	Maximum Speed ⁽²⁾ rpm	System Cont. Stall Current A (0-pk)	System Cont. Stall Torque N·m (lb·in)	System Cont. Rated Torque N·m (lb·in)	System Peak Stall Current A 0-pk	System Peak Stall Torque N·m (lb·in)	Motor Rated Output kW (Hp)	Kinetix 5700 Drives (480V AC input)
VPC-B1652A-xxxxAS	1500	2300	11.2	25.2 (223)	21.9 (194)	19.3	40.3 (357)	3.4 (4.6)	2198-D020-ERSx
VPC-B1652A-xxxxFS		4500 (2347)		25.5 (226)	25.5 (226)			4.0 (5.4)	
VPC-B1653A-xxxxAS	1500	2300	15.7	31.8 (281)	28.1 (249)	28.5	60.6 (536)	4.4 (5.9)	2198-D032-ERSx
VPC-B1653A-xxxxFS		4500 (2310)		35.1 (311)	35.1 (311)			5.5 (7.4)	
VPC-B1652D-xxxxAS	3000	4400	15.6	17.6 (156)	15.3 (135)	38.0	40.7 (360)	4.8 (6.4)	2198-D032-ERSx
VPC-B1652D-xxxxFS		5000 (4452)			17.6 (156)			5.5 (7.4)	
VPC-B1653D-xxxxAS	3000	4200	21.4	24.0 (212)	18.5 (164)	56.3	61.4 (543)	5.8 (7.8)	2198-D057-ERSx
VPC-B1653D-xxxxFS		5000 (4294)			24.0 (212)			7.5 (10.1)	
VPC-B1654D-xxxxAS	3000	4200	30.2	35.1 (311)	22.3 (197)	75.1	76.6 (678)	7.0 (9.4)	2198-D057-ERSx
VPC-B1654D-xxxxFS		5000 (4494)			35.1 (311)			11.0 (14.7)	
VPC-B21539-xxxxAS	1000	1500	15.6	52.5 (465)	51.1 (452)	41.6	118.8 (1051)	5.3 (7.2)	2198-D032-ERSx
VPC-B21539-xxxxFS		3000 (1573)			52.5 (465)			5.5 (7.4)	
VPC-B21549-xxxxAS	1000	1500	21.7	72.0 (637)	64.4 (570)	54.3	158.4 (1402)	6.7 (9.0)	2198-D057-ERSx
VPC-B21549-xxxxFS		3000 (1573)			72.0 (637)			7.5 (10.1)	
VPC-B2153A-xxxxAS	1500	2300	21.2	48.0 (425)	46.2 (409)	57.2	111.8 (990)	7.3 (9.7)	2198-D057-ERSx
VPC-B2153A-xxxxFS		4500 (2325)			48.0 (425)			7.5 (10.1)	
VPC-B2154A-xxxxAS	1500	2300	30.8	70.1 (620)	58.7 (520)	72.1	140.1 (1240)	9.2 (12.3)	2198-D057-ERSx
VPC-B2154A-xxxxFS		4500 (2333)			70.1 (620)			11.0 (14.7)	
VPC-B2154B-xxxxAS	2000	3200	41.0	48.0 (425)	45.1 (399)	120.1	131.4 (1163)	9.4 (12.6)	2198-S086-ERSx
VPC-B2154D-xxxxFS		5000 (4294)			48.0 (425)			15.0 (20.1)	
VPC-B2155B-xxxxAS	2000	3200	48.8	59.0 (522)	51.7 (458)	121.6	138.6 (1227)	10.8 (14.5)	2198-S086-ERSx
						139.5	156.7 (1387)		2198-S130-ERSx
VPC-B2155D-xxxxFS	3000	5000 (4172)	48.8	59.0 (522)	59.0 (522)	121.6	138.6 (1227)	18.5 (24.8)	2198-S086-ERSx
						139.5	156.7 (1387)		2198-S130-ERSx
VPC-B2156A-xxxxAS	1500	2800	57.6	70.1 (620)	56.1 (497)	121.6	139.3 (1233)	8.8 (11.8)	2198-S086-ERSx
						171.6	185.5 (1642)		2198-S130-ERSx
VPC-B2156D-xxxxFS	3000	5000 (4101)	57.6	70.1 (620)	70.1 (620)	121.6	139.3 (1233)	22.0 (29.5)	2198-S086-ERSx
						171.6	185.5 (1642)		2198-S130-ERSx
VPC-B30029-xxxxAS	1000	1400	29.2	103.4 (915)	100.2 (887)	56.9	183.7 (1626)	10.5 (14.1)	2198-S086-ERSx
VPC-B30029-xxxxFS		3000 (1493)		105.1 (930)	105.1 (930)			11.0 (14.7)	
VPC-B30039-xxxxAS	1000	1400	38.0	142.4 (1260)	135.7 (1201)	72.2	237.9 (2106)	14.2 (19.1)	2198-S086-ERSx
VPC-B30039-xxxxFS		3000 (1472)		143.3 (1268)	143.3 (1268)			15.0 (20.1)	
VPC-B30049-xxxxAS	1000	1400	46.6	176.1 (1558)	167.7 (1484)	96.6	327.8 (2901)	17.6 (23.6)	2198-S086-ERSx
VPC-B30049-xxxxFS		3000 (1429)		176.7 (1564)	176.7 (1564)			18.5 (24.8)	
VPC-B3002A-xxxxAS	1500	2200	39.6	95.5 (845)	90.6 (802)	82.9	170.4 (1508)	14.2 (19.1)	2198-S086-ERSx
VPC-B3002A-xxxxFS		4000 (2212)			95.5 (845)			15.0 (20.1)	
VPC-B3003A-xxxxAS	1500	2100	56.3	140.3 (1242)	111.3 (985)	108.0	244.8 (2167)	17.5 (23.4)	2198-S086-ERSx
VPC-B3003A-xxxxFS		3500 (2166)			140.3 (1242)			22.0 (29.5)	
VPC-B3004A-xxxxAS	1500	2100	77.6	191.1 (1691)	155.1 (1373)	145.2	319.0 (2823)	24.4 (34.1)	2198-S130-ERSx
VPC-B3004A-xxxxFS		3500 (2128)			191.1 (1691)			30.0 (40.2)	

Kinetix VPC Motor Performance Specifications with Kinetix 5700 (400V-class) Drives (continued)

Motor Cat. No. ⁽¹⁾	Rated Speed rpm	Maximum Speed ⁽²⁾ rpm	System Cont. Stall Current A (0-pk)	System Cont. Stall Torque N·m (lb·in)	System Cont. Rated Torque N·m (lb·in)	System Peak Stall Current A 0-pk	System Peak Stall Torque N·m (lb·in)	Motor Rated Output kW (Hp)	Kinetix 5700 Drives (480V AC input)
VPC-B3004B-xxxxAS	2000	2800	76.6	95.5 (845)	78.1 (691)	183.8	225.8 (1998)	16.4 (22.0)	2198-S130-ERSx
						211.1	257.7 (2281)		2198-S160-ERSx
VPC-B3004D-xxxxFS	3000	4000 (4054)	76.6	95.5 (845)	95.5 (845)	183.8	225.8 (1998)	30.0 (40.2)	2198-S130-ERSx
						211.1	257.7 (2281)		2198-S160-ERSx

(1) Motors with catalog numbers ending in -xxxxFS (forced ventilation) include a cooling fan. Catalog numbers ending in -xxxxAS (natural convection) do not include a cooling fan.

(2) Operation beyond maximum speed requires DC-bus protection. Bus overvoltage speed is shown in parentheses. See the Kinetix 5700 Servo Drives User Manual, publication [2198-UM002](#), for more information on bus overvoltage speed, field-weakening mode, and the extended speed feature.

Performance specification data and curves reflect nominal system performance of a typical system with the motor ambient at 40 °C (104 °F), drive ambient at 50 °C (122 °F), and rated line voltage. For additional information on ambient and line conditions, refer to Motion Analyzer software.

Kinetix 5700 (400V-class) Drives/Kinetix VPC Servo Motor Curves

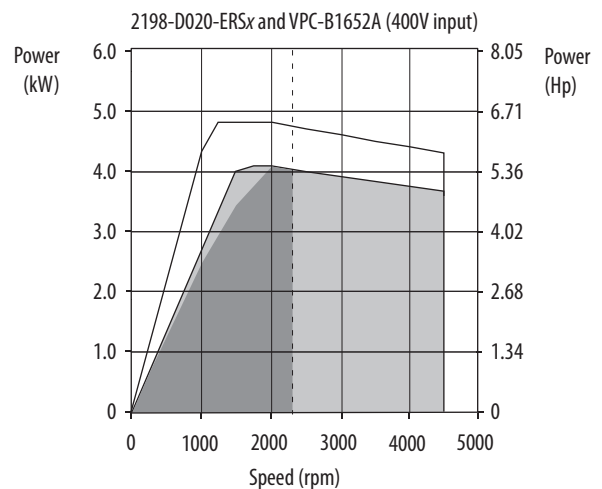
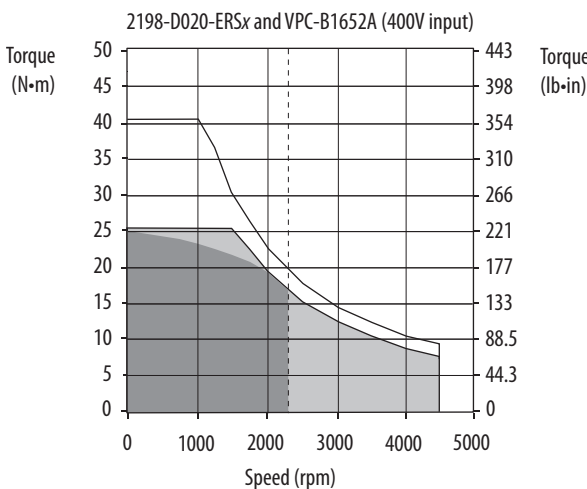
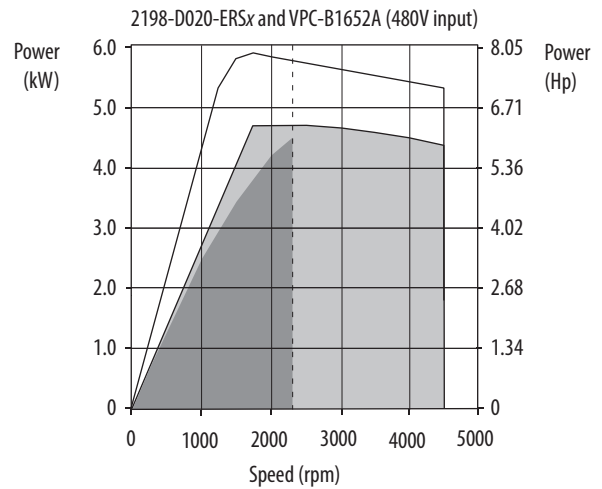
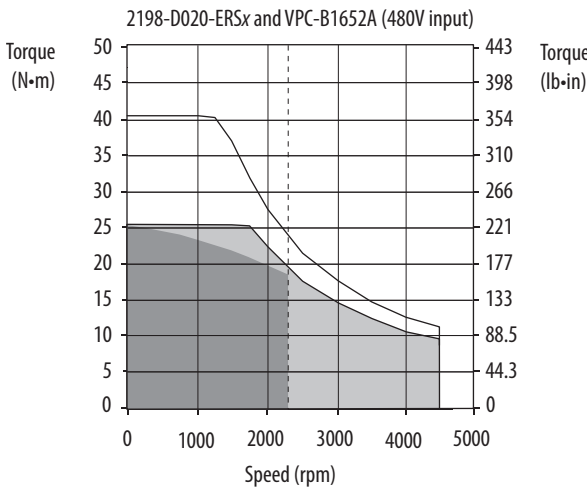

= Intermittent operating region (with and without cooling fan)
 = Continuous operating region with cooling fan
 = Continuous operating region without cooling fan
 = Bus overvoltage speed (maximum inverter safe-speed limit).
 Operation beyond this speed requires DC-bus protection.

Kinetix 5700 (400V-class) Drives/Kinetix VPC Servo Motor Curves (continued)

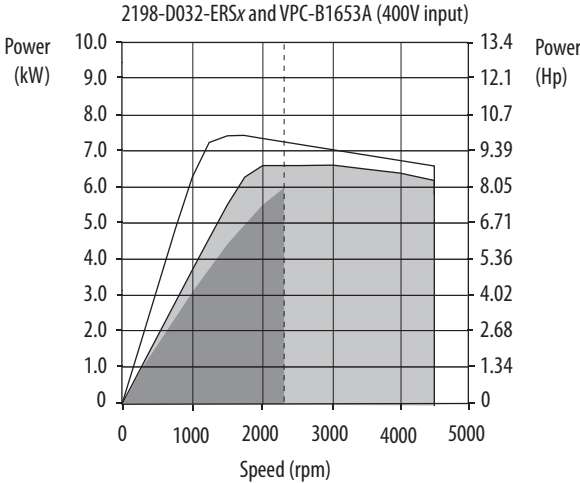
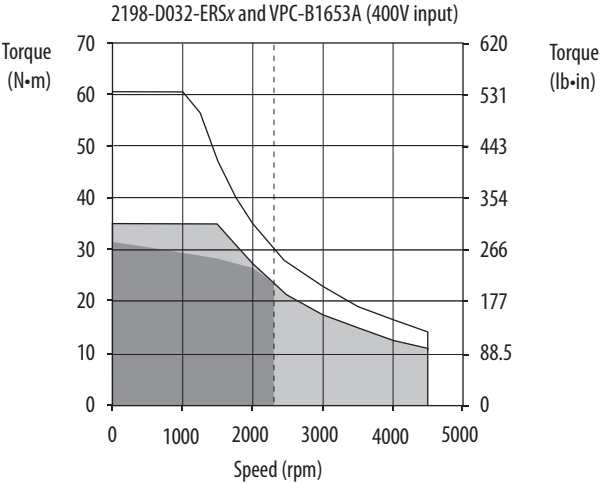
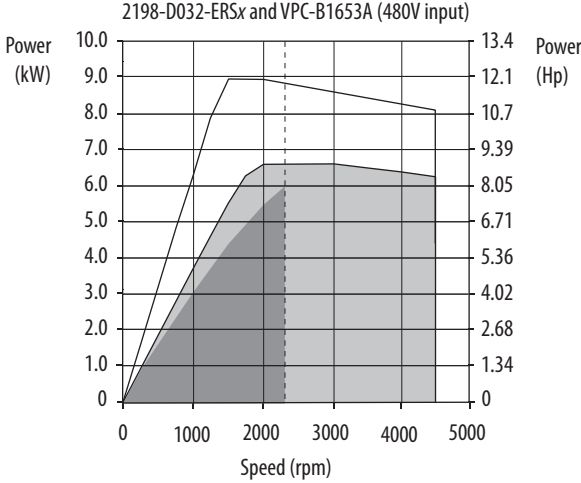
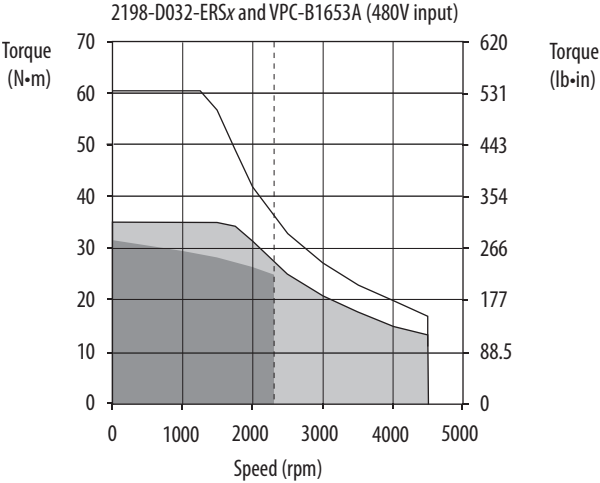

- = Intermittent operating region (with and without cooling fan)
- = Continuous operating region with cooling fan
- = Continuous operating region without cooling fan
- = Bus overvoltage speed (maximum inverter safe-speed limit).
Operation beyond this speed requires DC-bus protection.

Kinetix 5700 (400V-class) Drives/Kinetix VPC Servo Motors (continued)

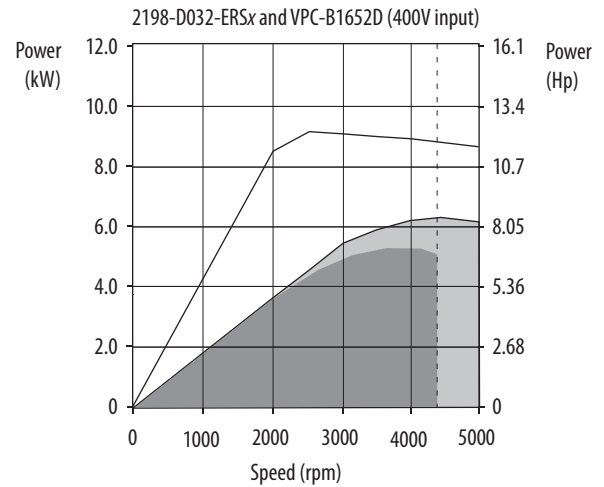
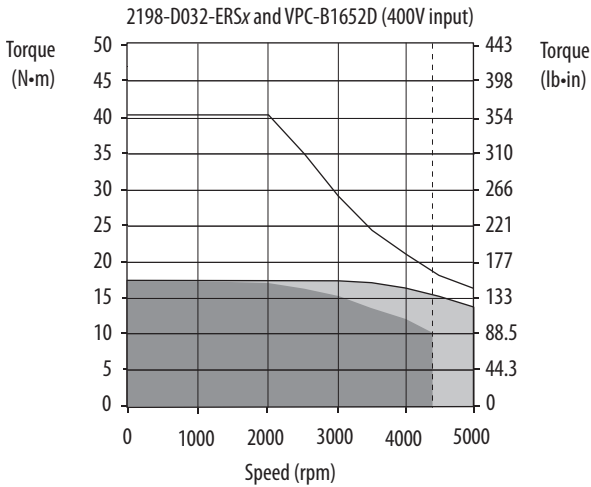
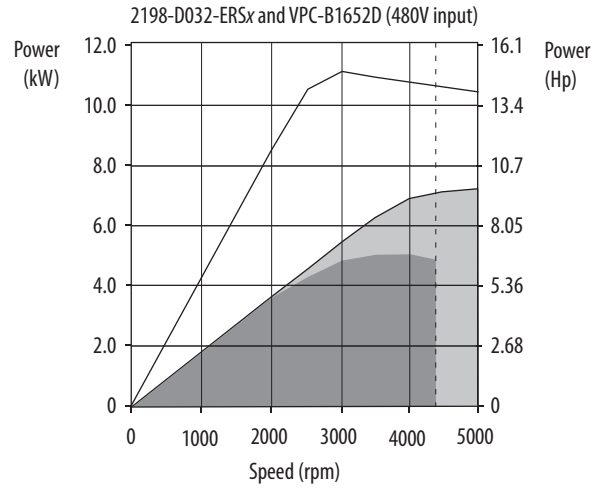
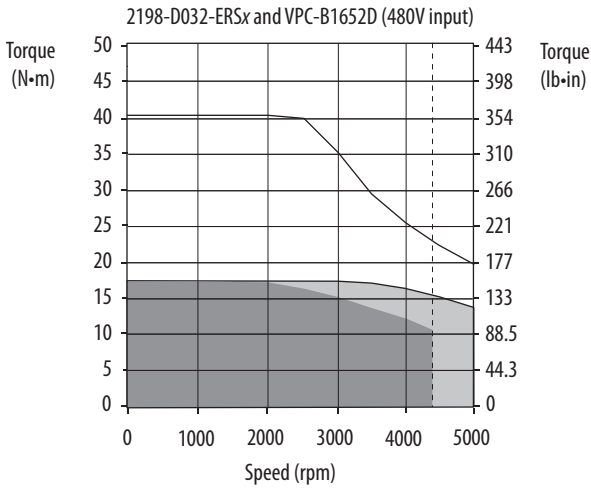

- = Intermittent operating region (with and without cooling fan)
- = Continuous operating region with cooling fan
- = Continuous operating region without cooling fan
- = Bus overvoltage speed (maximum inverter safe-speed limit).
Operation beyond this speed requires DC-bus protection.

Kinetix 5700 (400V-class) Drives/Kinetix VPC Servo Motor Curves (continued)

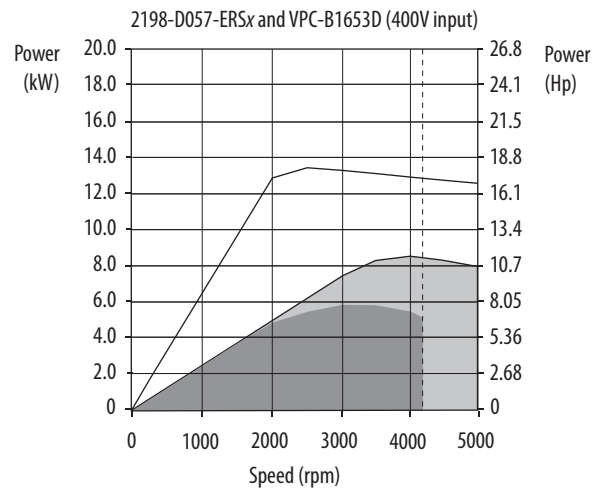
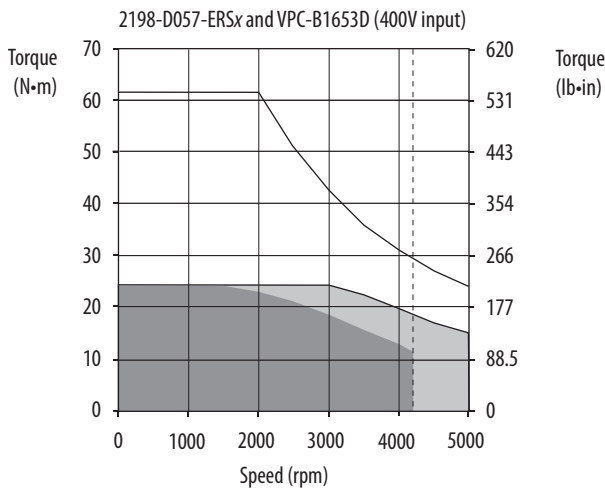
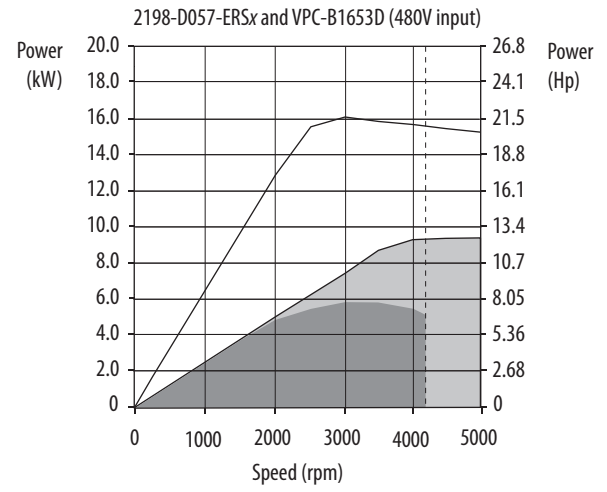
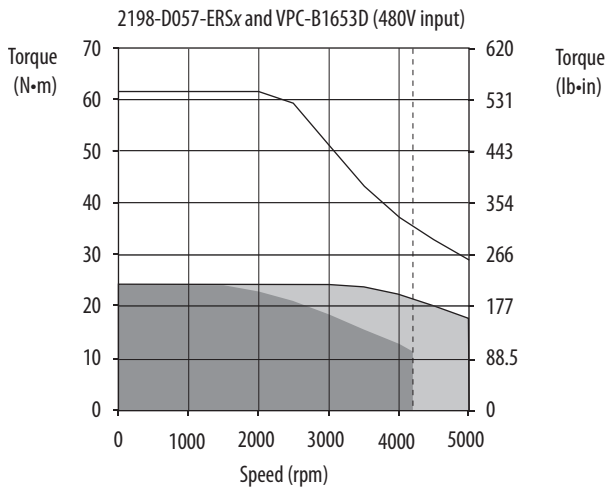

- = Intermittent operating region (with and without cooling fan)
- = Continuous operating region with cooling fan
- = Continuous operating region without cooling fan
- = Bus overvoltage speed (maximum inverter safe-speed limit).
Operation beyond this speed requires DC-bus protection.

Kinetix 5700 (400V-class) Drives/Kinetix VPC Servo Motor Curves (continued)

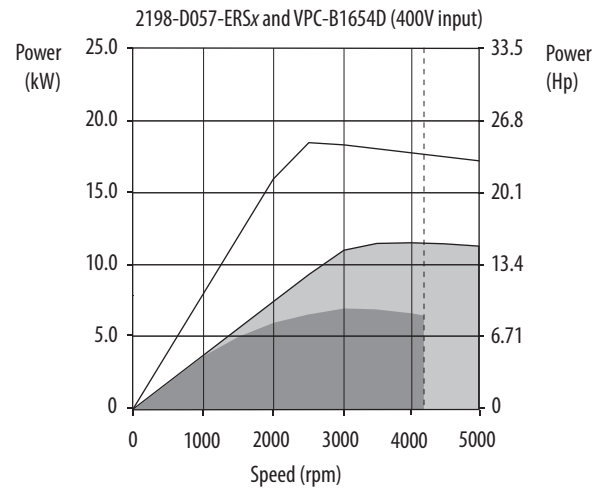
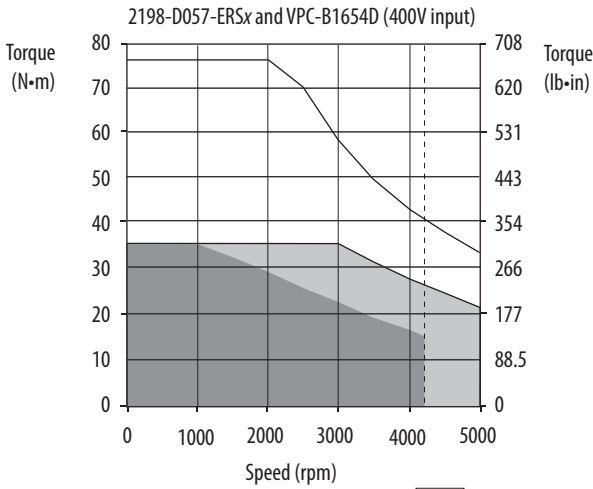
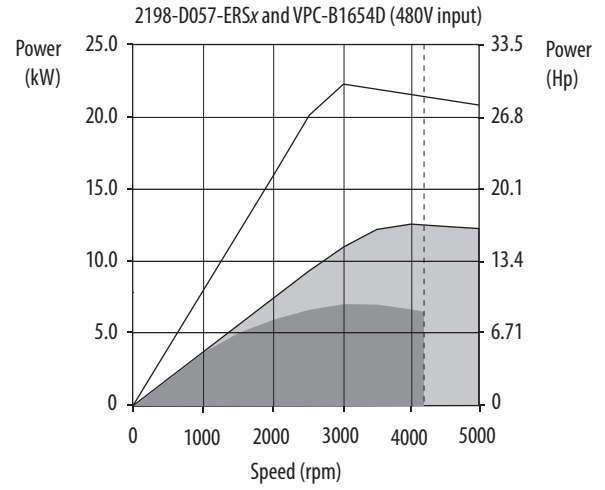
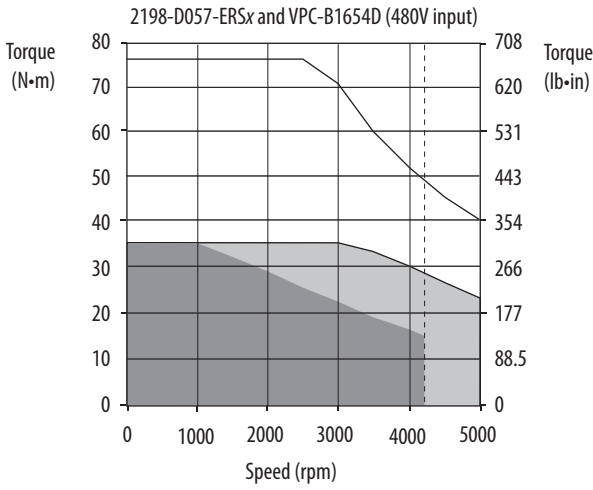

- = Intermittent operating region (with and without cooling fan)
- = Continuous operating region with cooling fan
- = Continuous operating region without cooling fan
- = Bus overvoltage speed (maximum inverter safe-speed limit).
Operation beyond this speed requires DC-bus protection.

Kinetix 5700 (400V-class) Drives/Kinetix VPC Servo Motor Curves (continued)

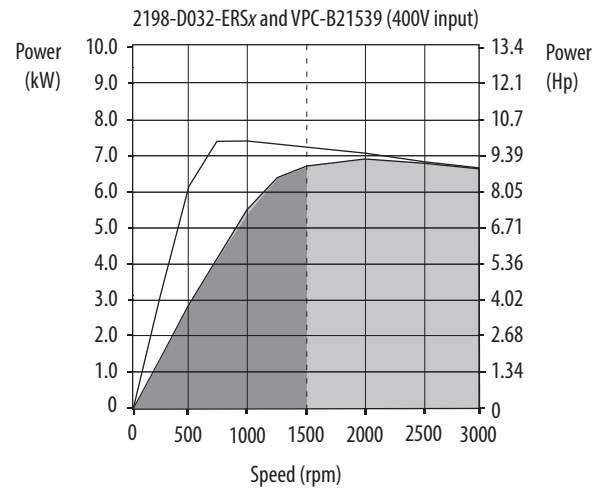
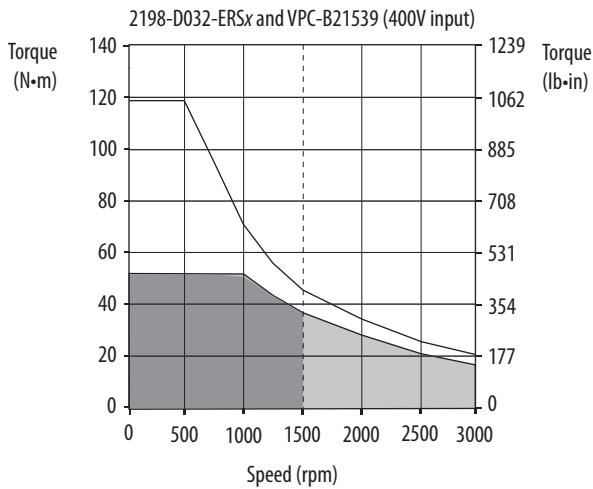
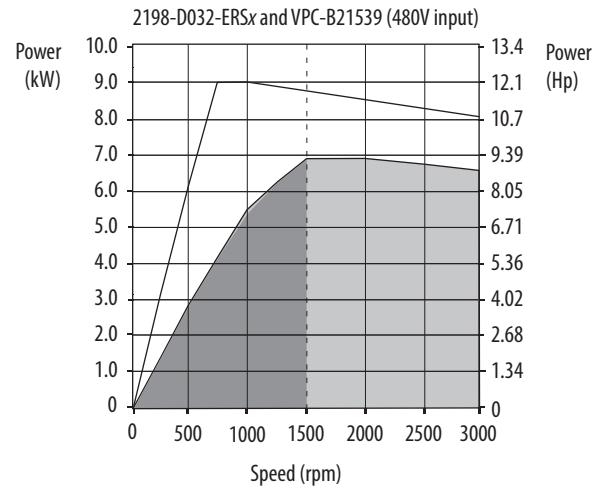
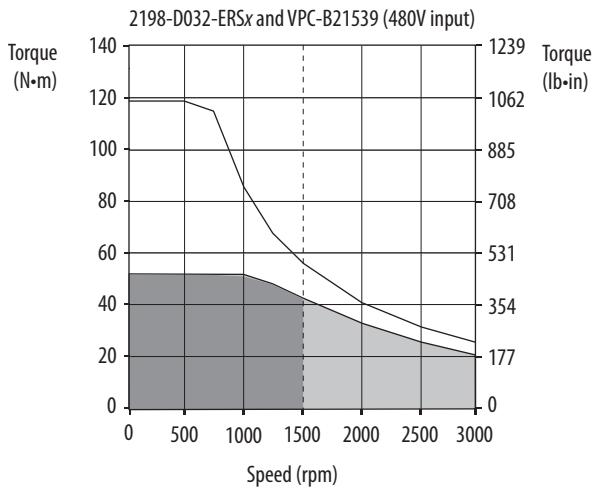

- = Intermittent operating region (with and without cooling fan)
- = Continuous operating region with cooling fan
- = Continuous operating region without cooling fan
- = Bus overvoltage speed (maximum inverter safe-speed limit). Operation beyond this speed requires DC-bus protection.

Kinetix 5700 (400V-class) Drives/Kinetix VPC Servo Motor Curves (continued)

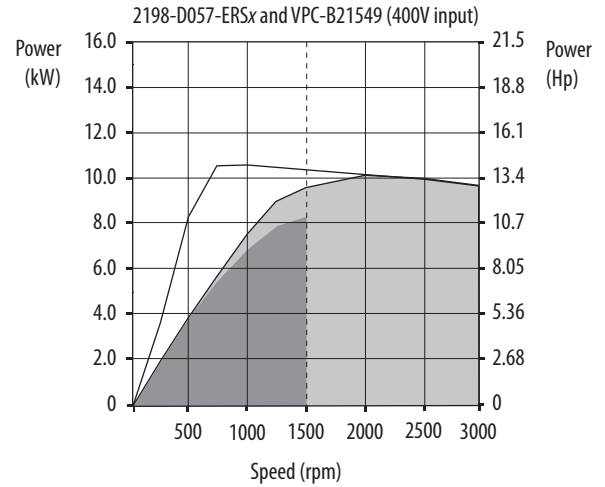
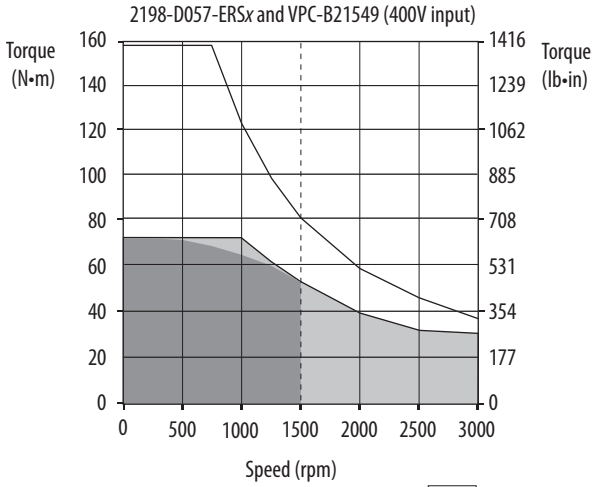
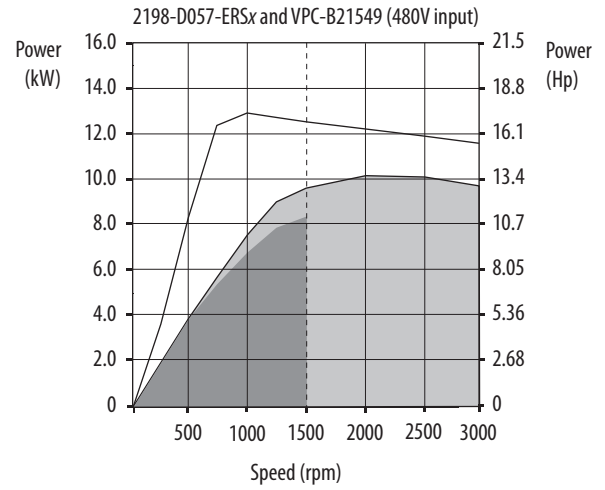
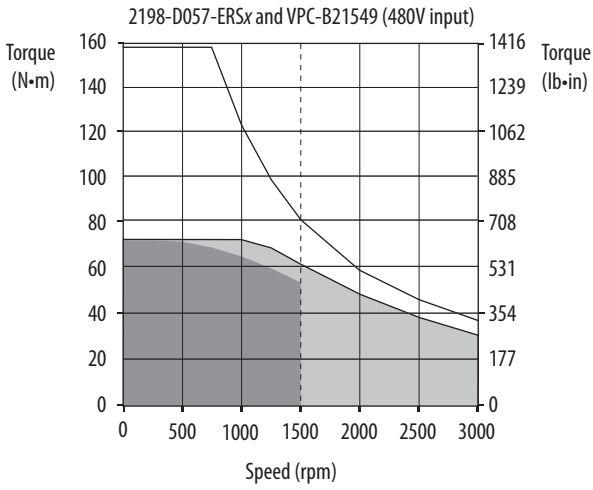

- = Intermittent operating region (with and without cooling fan)
- = Continuous operating region with cooling fan
- = Continuous operating region without cooling fan
- = Bus overvoltage speed (maximum inverter safe-speed limit).
Operation beyond this speed requires DC-bus protection.

Kinetix 5700 (400V-class) Drives/Kinetix VPC Servo Motor Curves (continued)

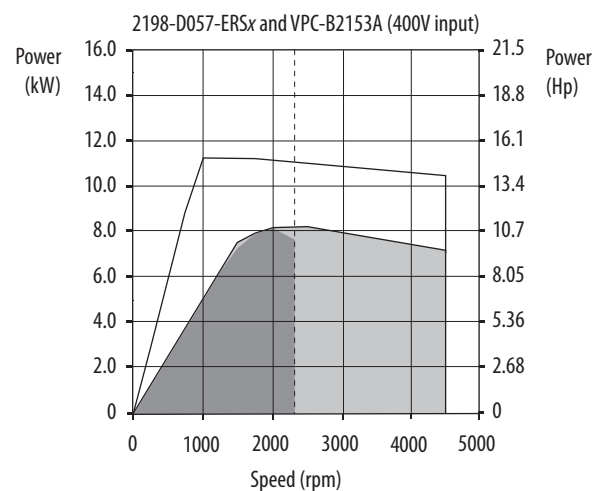
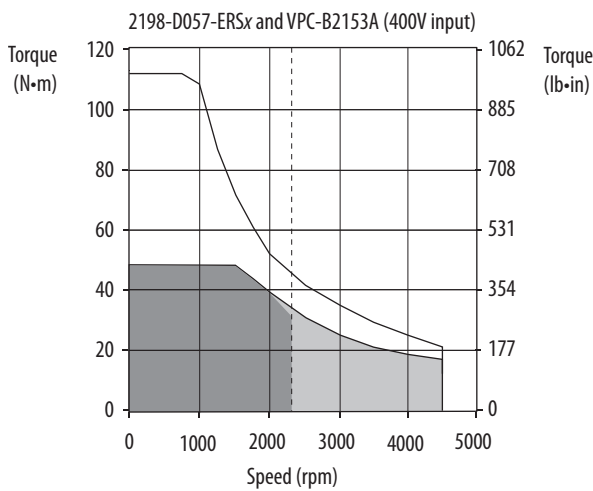
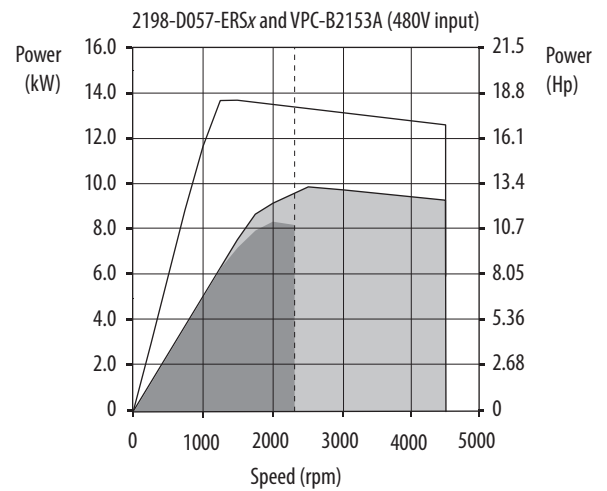
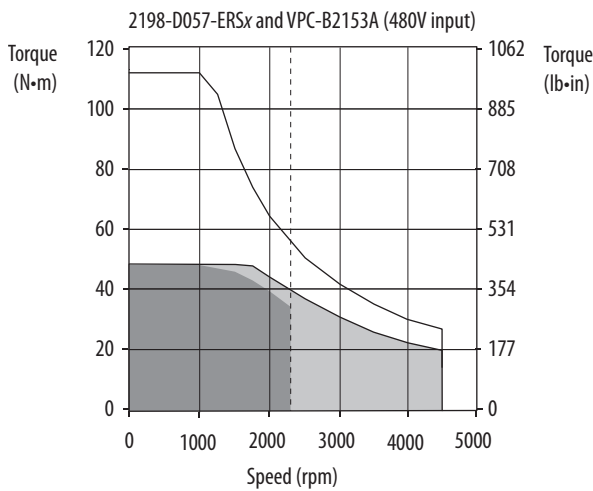

- = Intermittent operating region (with and without cooling fan)
- = Continuous operating region with cooling fan
- = Continuous operating region without cooling fan
- = Bus overvoltage speed (maximum inverter safe-speed limit).
Operation beyond this speed requires DC-bus protection.

Kinetix 5700 (400V-class) Drives/Kinetix VPC Servo Motor Curves (continued)

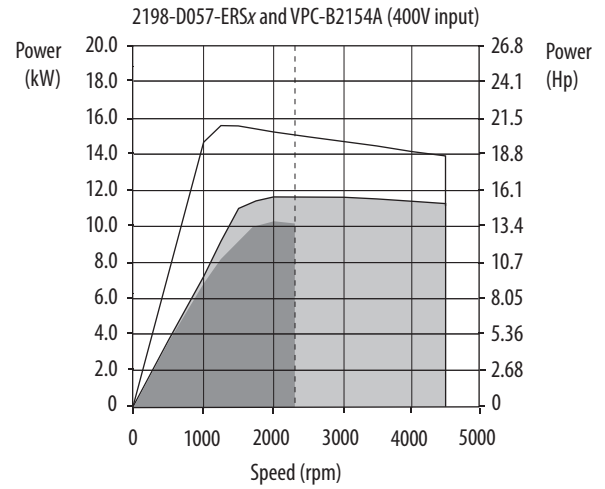
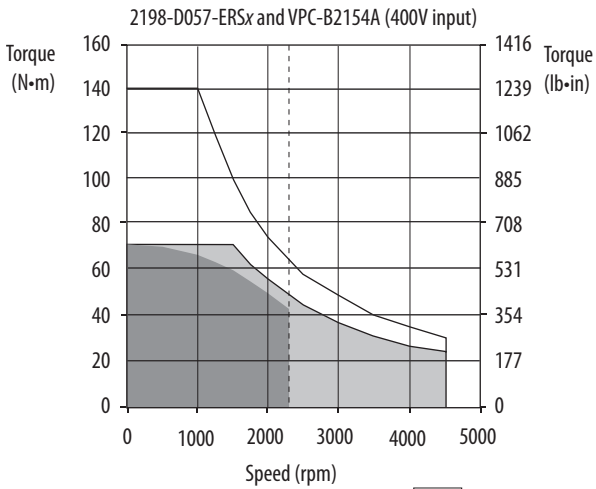
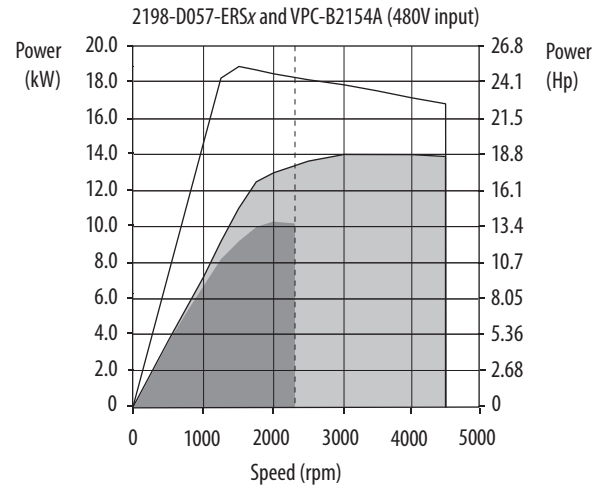
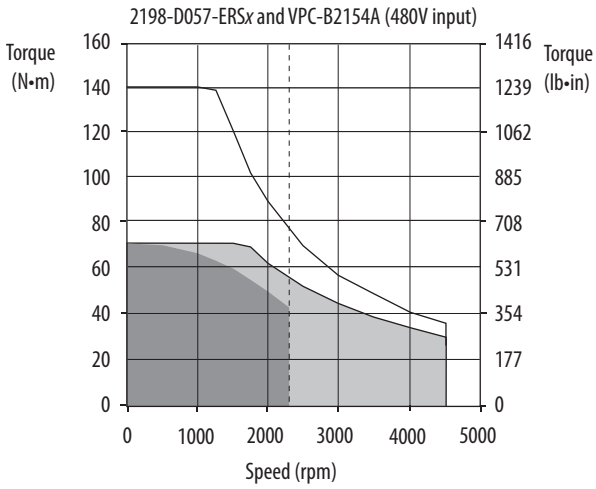

- = Intermittent operating region (with and without cooling fan)
- = Continuous operating region with cooling fan
- = Continuous operating region without cooling fan
- = Bus overvoltage speed (maximum inverter safe-speed limit).
Operation beyond this speed requires DC-bus protection.

Kinetix 5700 (400V-class) Drives/Kinetix VPC Servo Motor Curves (continued)

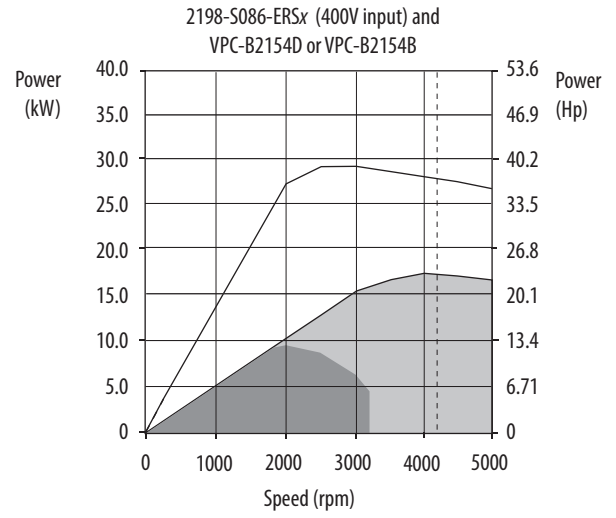
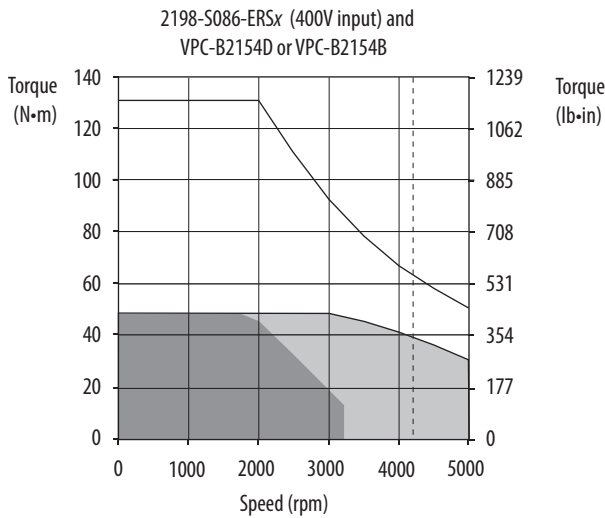
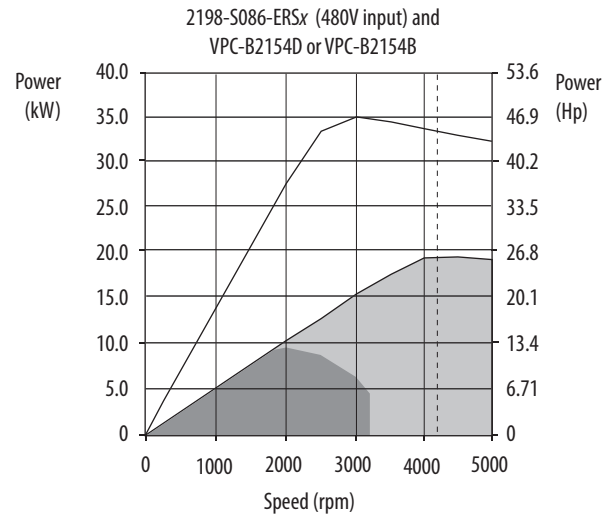
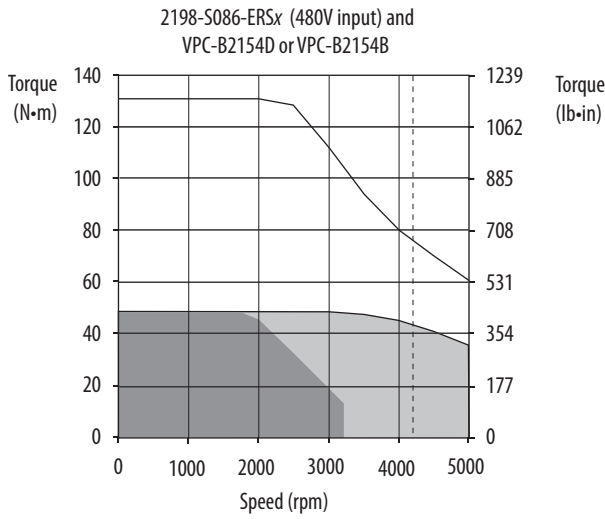

- = Intermittent operating region (with and without cooling fan)
- = Continuous operating region with cooling fan
- = Continuous operating region without cooling fan
- = Bus overvoltage speed (maximum inverter safe-speed limit).
Operation beyond this speed requires DC-bus protection.

Kinetix 5700 (400V-class) Drives/Kinetix VPC Servo Motor Curves (continued)

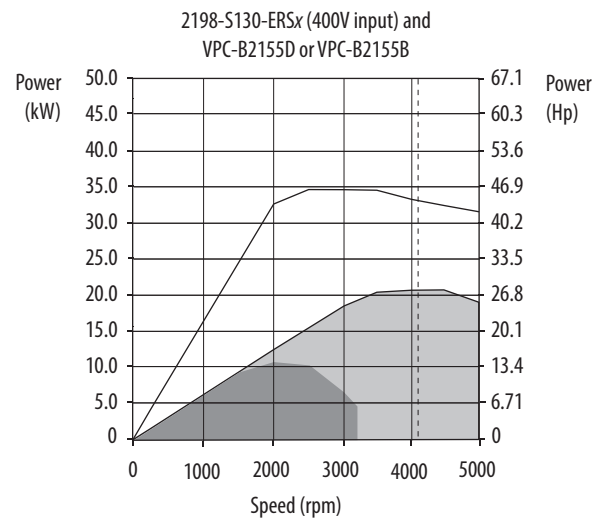
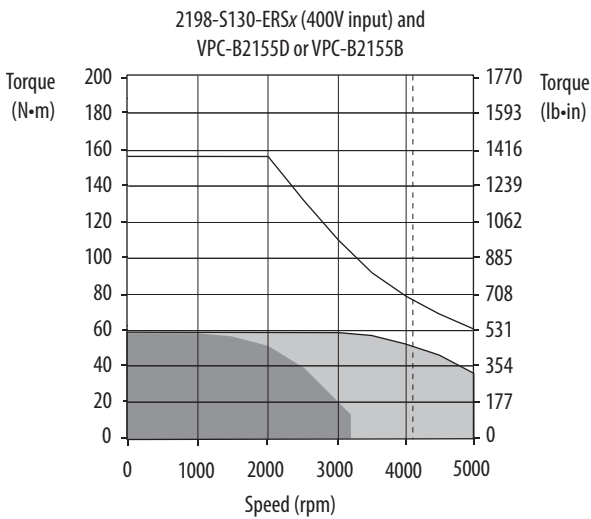
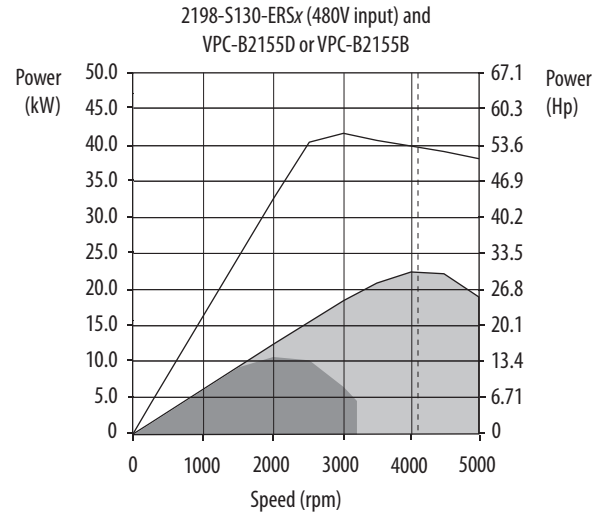
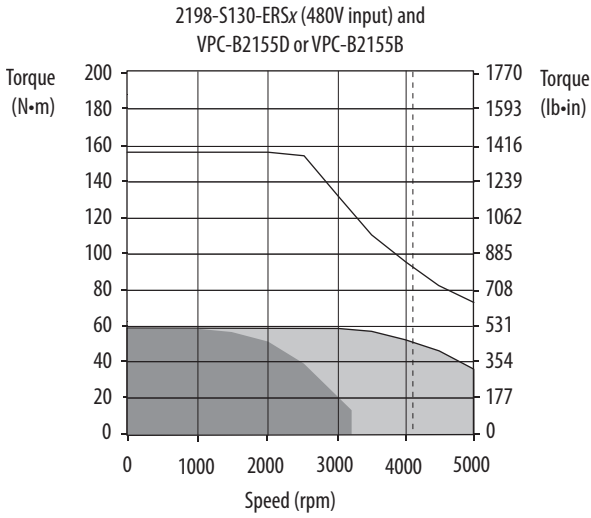

- = Intermittent operating region (with and without cooling fan)
- = Continuous operating region with cooling fan
- = Continuous operating region without cooling fan
- = Bus overvoltage speed (maximum inverter safe-speed limit).
Operation beyond this speed requires DC-bus protection.

Kinetix 5700 (400V-class) Drives/Kinetix VPC Servo Motor Curves (continued)

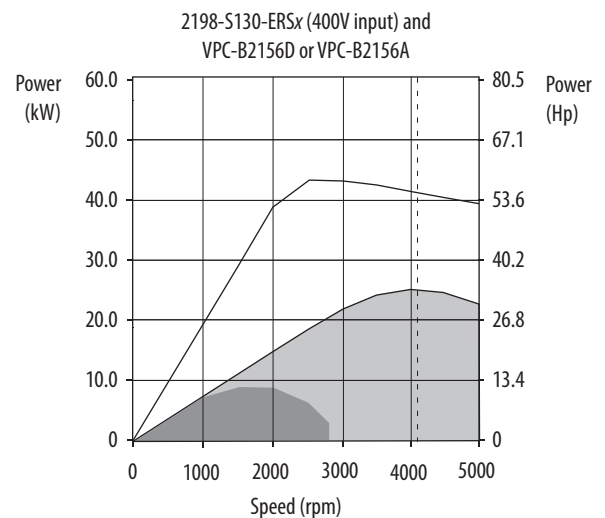
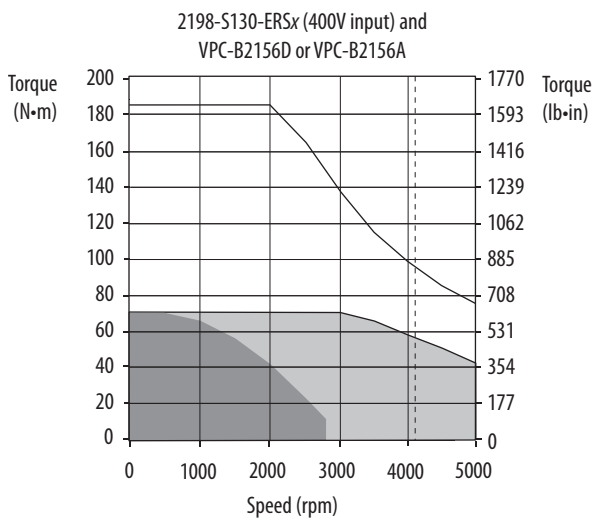
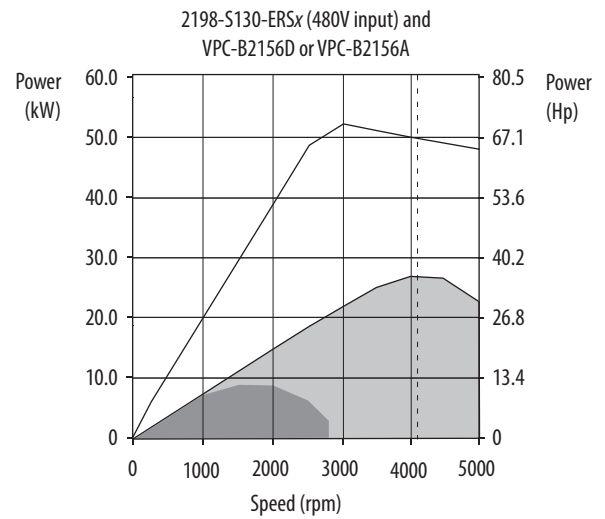
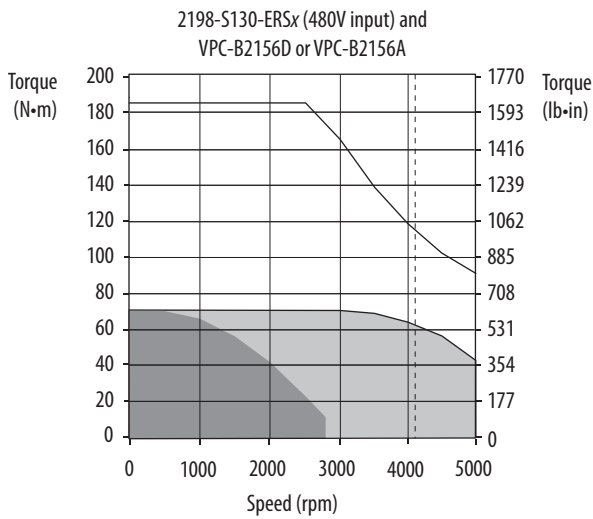

- = Intermittent operating region (with and without cooling fan)
- = Continuous operating region with cooling fan
- = Continuous operating region without cooling fan
- = Bus overvoltage speed (maximum inverter safe-speed limit).
Operation beyond this speed requires DC-bus protection.

Kinetix 5700 (400V-class) Drives/Kinetix VPC Servo Motor Curves (continued)

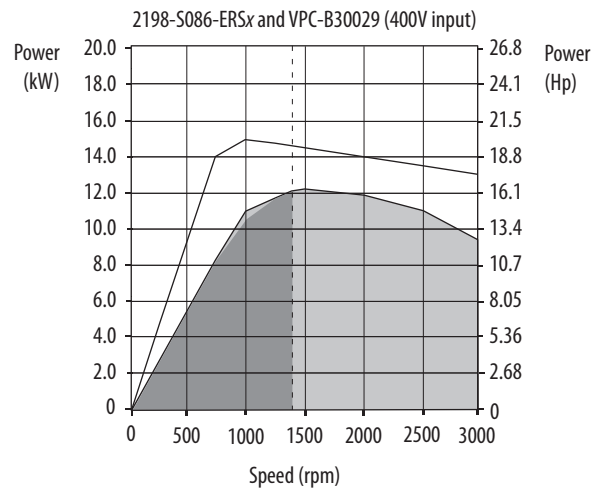
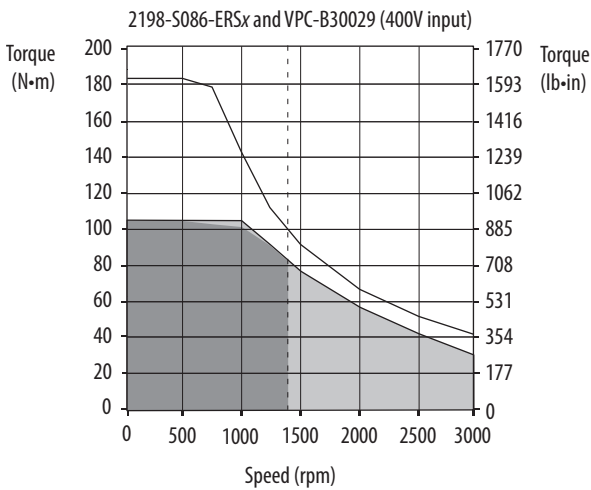
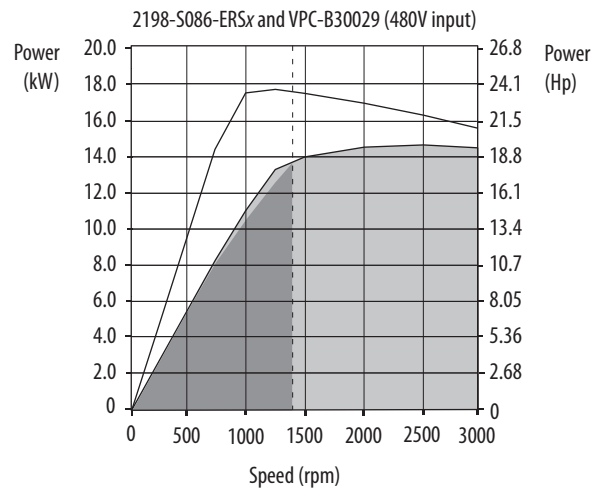
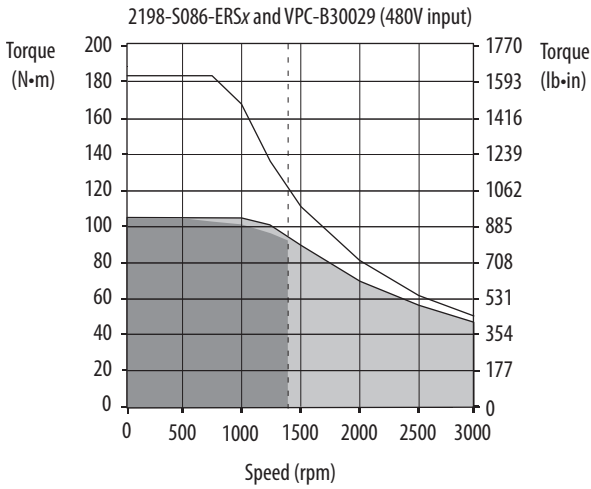

- = Intermittent operating region (with and without cooling fan)
- = Continuous operating region with cooling fan
- = Continuous operating region without cooling fan
- = Bus overvoltage speed (maximum inverter safe-speed limit).
Operation beyond this speed requires DC-bus protection.

Kinetix 5700 (400V-class) Drives/Kinetix VPC Servo Motor Curves (continued)

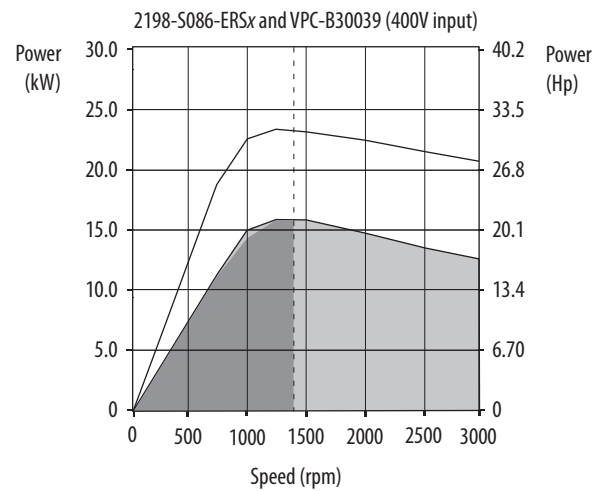
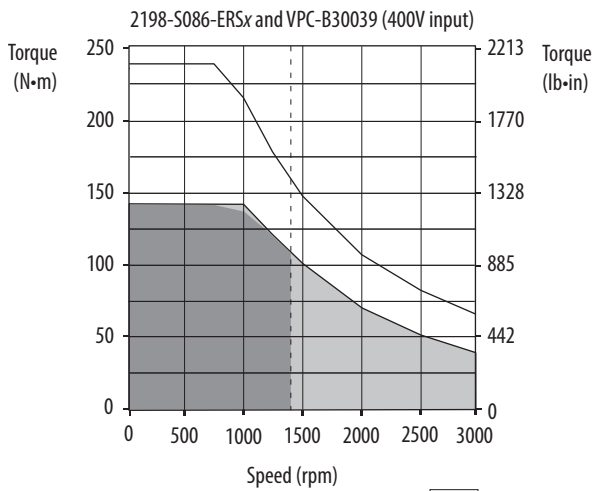
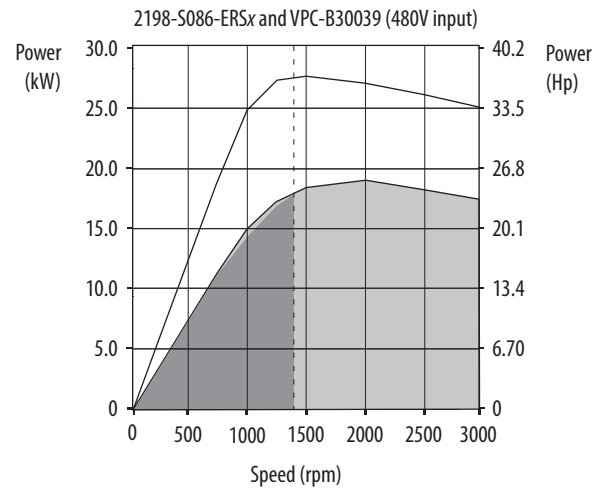
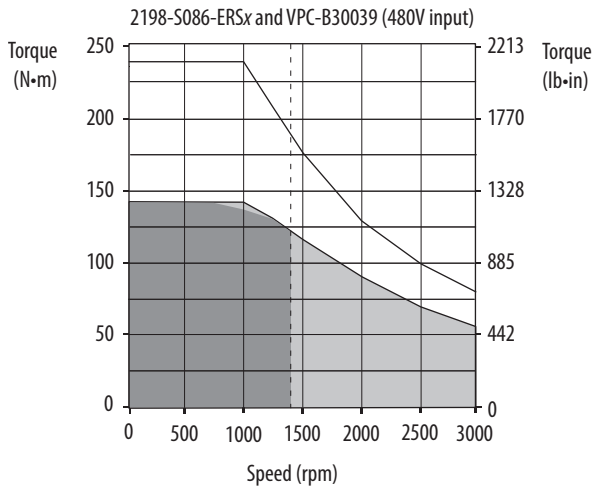

- = Intermittent operating region (with and without cooling fan)
- = Continuous operating region with cooling fan
- = Continuous operating region without cooling fan
- = Bus overvoltage speed (maximum inverter safe-speed limit).
Operation beyond this speed requires DC-bus protection.

Kinetix 5700 (400V-class) Drives/Kinetix VPC Servo Motor Curves (continued)

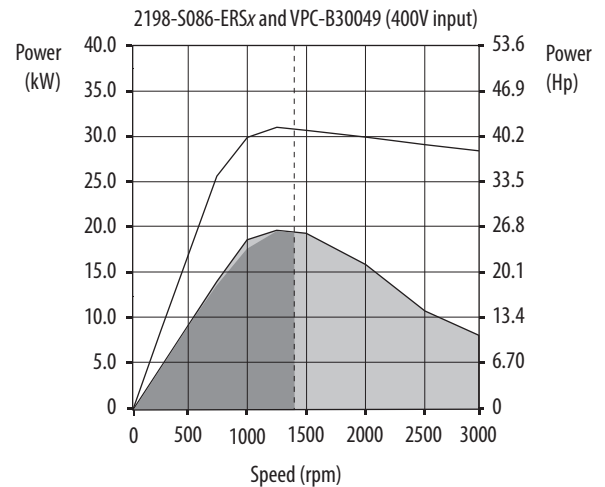
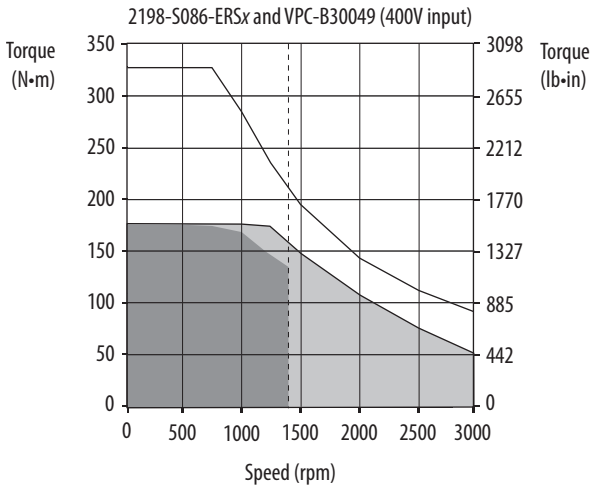
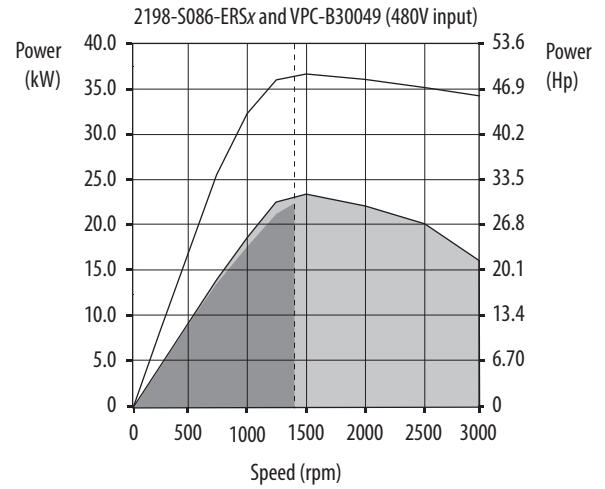
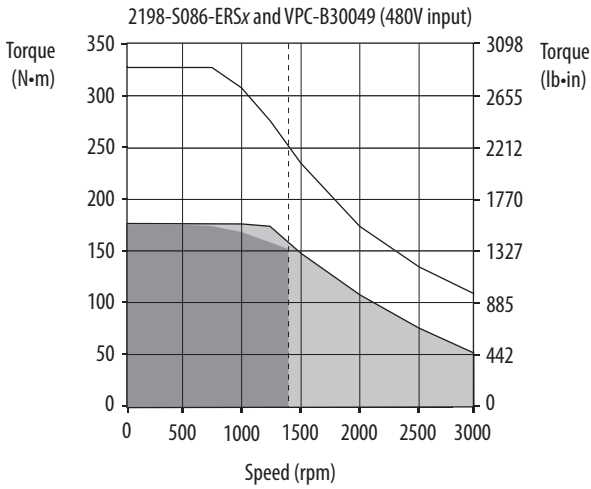

- = Intermittent operating region (with and without cooling fan)
- = Continuous operating region with cooling fan
- = Continuous operating region without cooling fan
- = Bus overvoltage speed (maximum inverter safe-speed limit).
Operation beyond this speed requires DC-bus protection.

Kinetix 5700 (400V-class) Drives/Kinetix VPC Servo Motor Curves (continued)

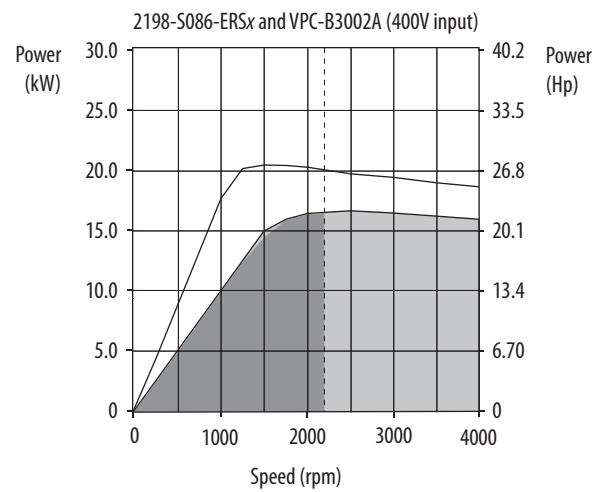
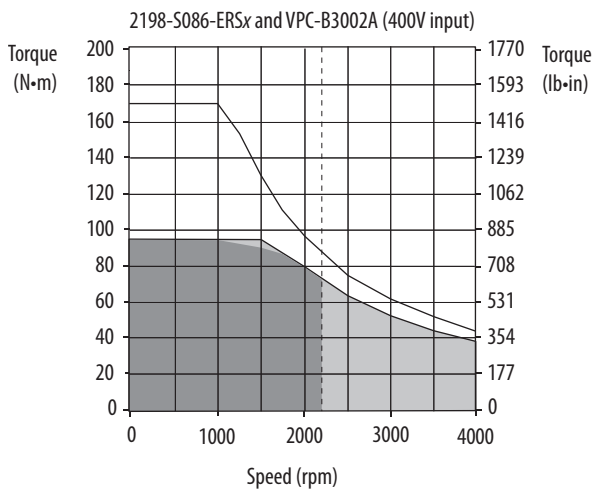
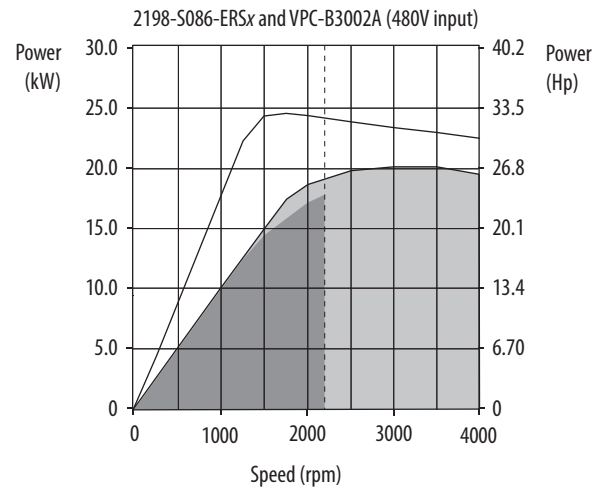
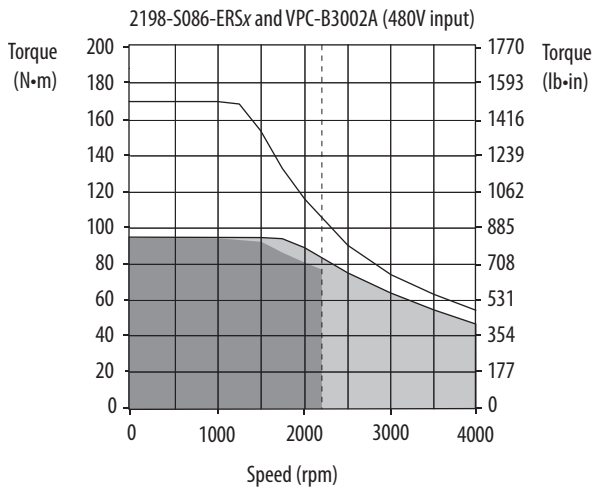

- = Intermittent operating region (with and without cooling fan)
- = Continuous operating region with cooling fan
- = Continuous operating region without cooling fan
- = Bus overvoltage speed (maximum inverter safe-speed limit).
Operation beyond this speed requires DC-bus protection.

Kinetix 5700 (400V-class) Drives/Kinetix VPC Servo Motor Curves (continued)

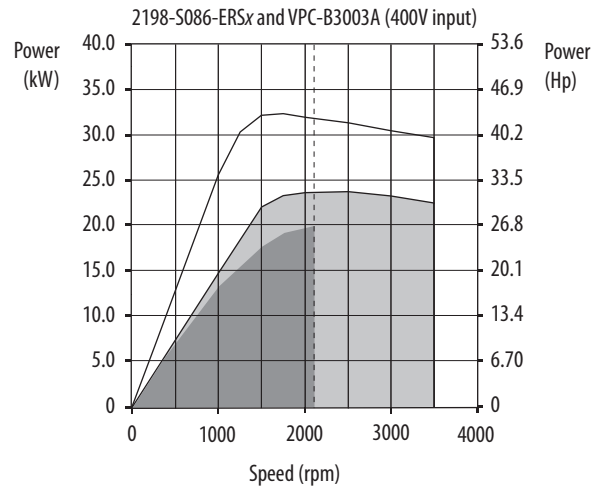
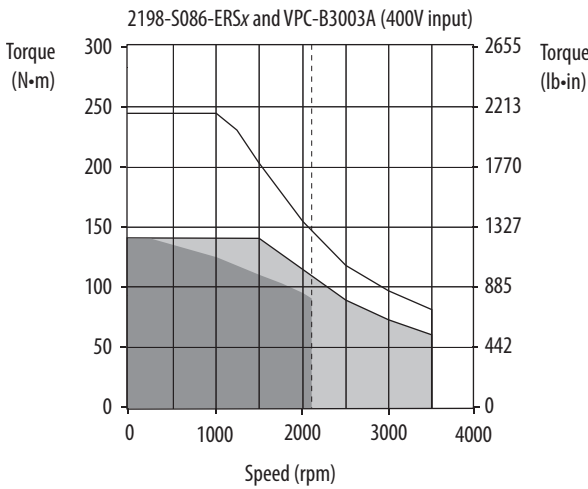
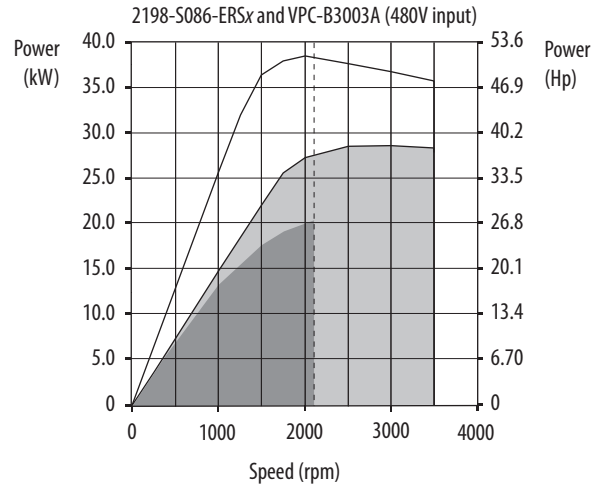
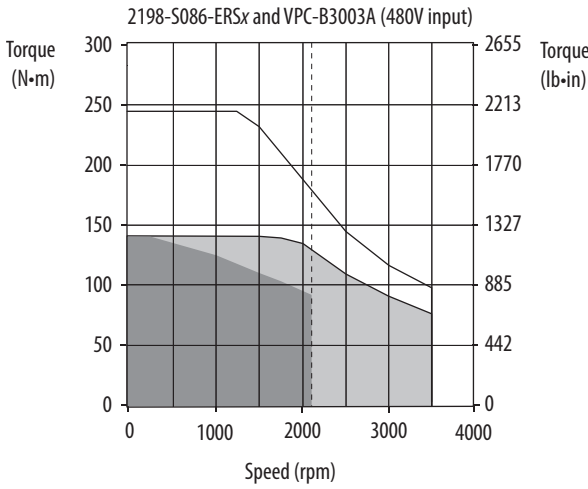

- = Intermittent operating region (with and without cooling fan)
- = Continuous operating region with cooling fan
- = Continuous operating region without cooling fan
- = Bus overvoltage speed (maximum inverter safe-speed limit).
Operation beyond this speed requires DC-bus protection.

Kinetix 5700 (400V-class) Drives/Kinetix VPC Servo Motor Curves (continued)

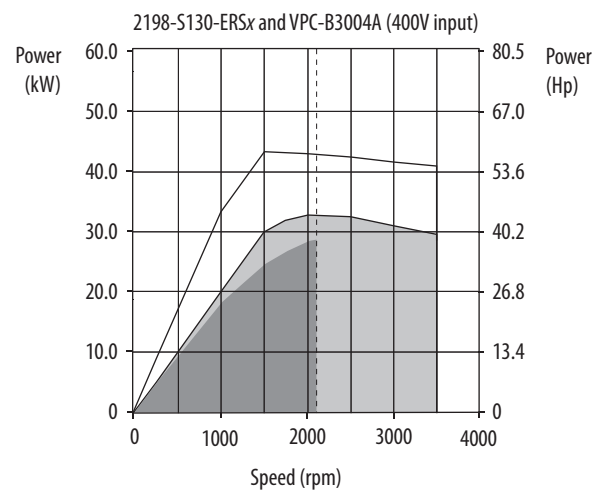
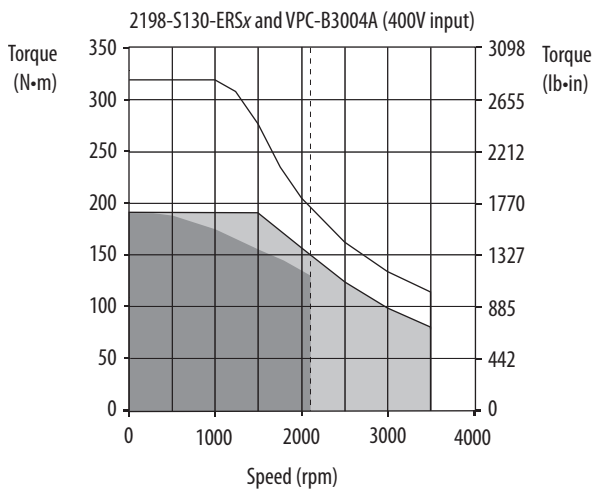
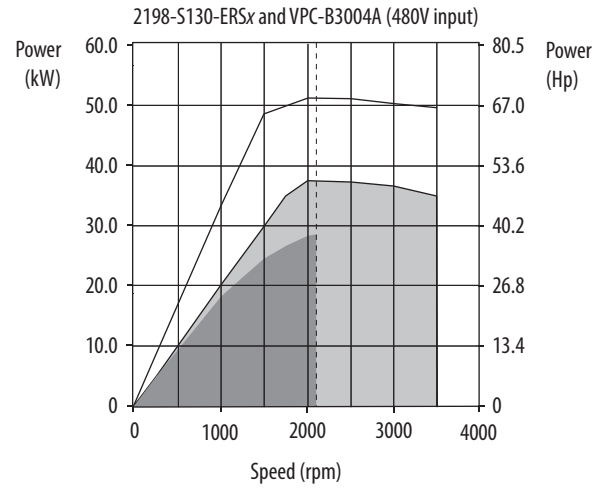
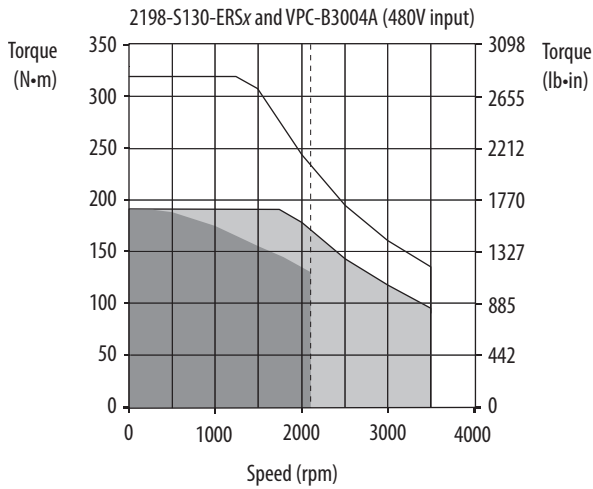

- = Intermittent operating region (with and without cooling fan)
- = Continuous operating region with cooling fan
- = Continuous operating region without cooling fan
- = Bus overvoltage speed (maximum inverter safe-speed limit).
Operation beyond this speed requires DC-bus protection.

Kinetix 5700 (400V-class) Drives/Kinetix VPC Servo Motor Curves (continued)

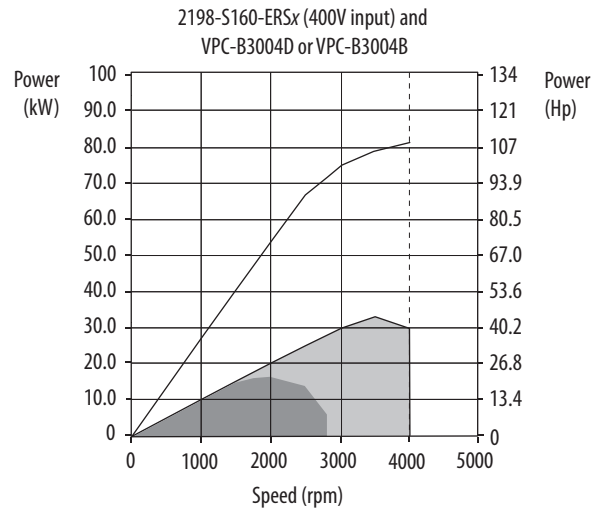
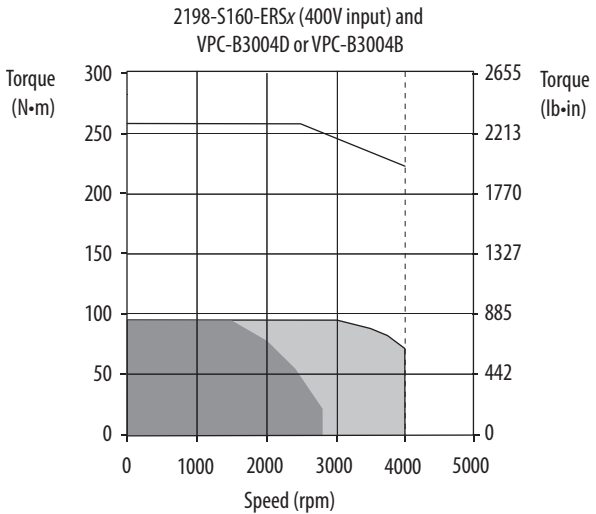
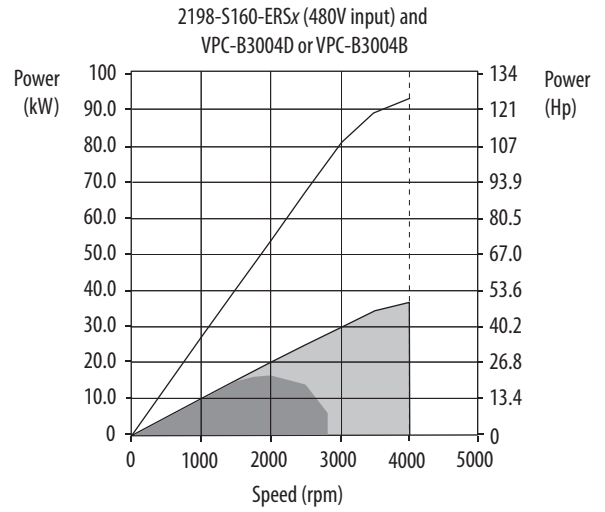
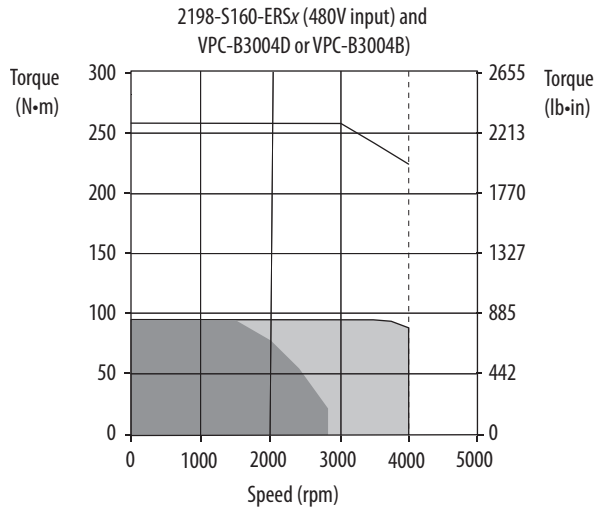

- = Intermittent operating region (with and without cooling fan)
- = Continuous operating region with cooling fan
- = Continuous operating region without cooling fan
- = Bus overvoltage speed (maximum inverter safe-speed limit).
Operation beyond this speed requires DC-bus protection.

Kinetix 5700 (400V-class) Drives with Kinetix VPF Food-grade Motors

This section provides system combination information for the Kinetix 5700 drives (with 400 and 480V, nominal input) when matched with Kinetix VPF (400V-class) servo motors. Single-cable catalog numbers, system performance specifications, and the optimum torque/speed curves are included.

Kinetix VPF Motor Cable Combinations

Rotary Motor (400V-class) Cat. No.	Single Motor Cable ⁽¹⁾	Feedback Type
VPF-B0632F, VPF-B0632T, VPF-B0633M, VPF-B0633T	2090-CSBM1Dx-18xAxx or 2090-CSWM1Dx-18xAxx (standard, non-flex) 2090-CSBM1Dx-18xFxx (continuous-flex)	Single-turn or Absolute, Multi-turn Digital Encoder • SIL 2/PLD Rated • Hiperface DSL Protocol
VPF-B0752E, VPF-B0752F, VPF-B0752M, VPF-B0753E, VPF-B0753F, VPF-B0753M		
VPF-B1001M, VPF-B1002E, VPF-B1003C, VPF-B1003F		
VPF-B1153E		
VPF-B1002M, VPF-B1003T	2090-CSBM1Dx-14xAxx or 2090-CSWM1Dx-14xAxx (standard, non-flex) 2090-CSBM1Dx-14xFxx (continuous-flex)	
VPF-B1153F		
VPF-B1303C, VPF-B1303F, VPF-B1304C, VPF-B1304E		
VPF-B1652C		

(1) Use 2090-CSxM1DE or 2090-CSxM1DG cables. Cable length xx is in meters, 01 (3.3) . . . 50 (164) in 1.0 m (3.3 ft) increments. For information on maximum cable lengths see Kinetix 5700 Servo Drives User Manual, publication [2198-UM002](#). Refer to the Kinetix Motion Accessories Technical Data, publication [KNX-TD004](#), for cable specifications. For cable configuration illustrations and feature descriptions, by catalog number, refer to 2090-Series Single Motor Cable Overview beginning on [page 18](#).

Kinetix VPF Motor Performance Specifications with Kinetix 5700 (400V-class) Drives

Rotary Motor Cat. No.	Rated Speed rpm	Maximum Speed rpm	System Continuous Stall Current A (0-pk)	System Continuous Stall Torque N·m (lb·in)	System Peak Stall Current A 0-pk	System Peak Stall Torque N·m (lb·in)	Motor Rated Output kW (Hp)	Kinetix 5700 Drives (480V AC input)
VPF-B0632F	4600	4600	1.20	0.93 (8.0)	4.20	2.69 (24.0)	0.34 (0.46)	2198-D006-ERSx
VPF-B0632T	8000	8000	2.55	0.93 (8.0)	8.75	2.69 (24.0)	0.41 (0.55)	2198-D006-ERSx
VPF-B0633M	6700	6700	2.50	1.27 (11.0)	8.75	4.09 (36.0)	0.49 (0.66)	2198-D006-ERSx
VPF-B0633T	8000	8000	3.52	1.27 (11.0)	8.80	2.87 (25.0)	0.48 (0.64)	2198-D006-ERSx
					12.60	4.09 (36.0)		2198-D012-ERSx
VPF-B0752E	4900	4900	2.70	1.61 (14.0)	8.80	4.10 (36.0)	0.64 (0.86)	2198-D006-ERSx
					9.45	4.39 (39.0)		2198-D012-ERSx
VPF-B0752F	7000	7000	3.80	1.61 (14.0)	13.30	4.39 (39.0)	0.76 (1.02)	2198-D012-ERSx
VPF-B0752M	8000	8000	4.90	1.61 (14.0)	17.60	4.10 (36.0)	0.77 (1.04)	2198-D012-ERSx
					18.90	4.39 (39.0)		2198-D020-ERSx
VPF-B0753E	4500	4500	3.80	2.28 (20.0)	13.30	7.35 (65.0)	0.77 (1.04)	2198-D012-ERSx
VPF-B0753F	6600	6600	4.09	2.16 (19.0)	17.60	6.55 (58.0)	0.61 (0.82)	2198-D012-ERSx
					18.90	7.02 (62.0)		2198-D020-ERSx
VPF-B0753M	8000	8000	6.12	2.28 (20.0)	17.60	5.13 (45.0)	0.78 (1.05)	2198-D012-ERSx
					25.34	7.35 (65.0)		2198-D020-ERSx
VPF-B1001M	6000	6000	3.61	1.93 (17.0)	8.80	3.22 (28.0)	1.14 (1.53)	2198-D006-ERSx
					10.38	3.78 (33.0)		2198-D012-ERSx
VPF-B1002E	3300	3300	3.44	3.39 (30.0)	8.80	6.47 (57.0)	1.12 (1.50)	2198-D006-ERSx
					10.69	7.82 (69.0)		2198-D012-ERSx
VPF-B1002M	6000	6000	6.24	3.39 (30.0)	17.60	6.80 (60.0)	1.86 (2.49)	2198-D012-ERSx
					20.33	7.82 (69.0)		2198-D020-ERSx

Kinetix VPF Motor Performance Specifications with Kinetix 5700 (400V-class) Drives (continued)

Rotary Motor Cat. No.	Rated Speed rpm	Maximum Speed rpm	System Continuous Stall Current A (0-pk)	System Continuous Stall Torque N·m (lb·in)	System Peak Stall Current A 0-pk	System Peak Stall Torque N·m (lb·in)	Motor Rated Output kW (Hp)	Kinetix 5700 Drives (480V AC input)
VPF-B1003C	2500	2500	3.41	4.18 (37.0)	8.80	9.29 (82.0)	0.91 (1.23)	2198-D006-ERSx
					10.61	11.15 (99.0)		2198-D012-ERSx
VPF-B1003F	4750	4750	6.14	4.18 (37.0)	17.60	9.76 (86.0)	1.57 (2.10)	2198-D012-ERSx
					20.20	11.15 (99.0)		2198-D020-ERSx
VPF-B1003T	7000	7000	9.58	4.18 (37.0)	28.20	9.76 (86.0)	1.68 (2.25)	2198-D020-ERSx
					28.80	11.15 (99.0)		2198-D032-ERSx
VPF-B1153E	3200	3200	6.13	6.50 (58.0)	17.60	16.85 (149)	1.40 (1.88)	2198-D012-ERSx
					21.33	20.33 (180)		2198-D020-ERSx
VPF-B1153F	5000	5000	8.88	6.50 (58.0)	28.20	18.30 (162)	1.49 (2.00)	2198-D020-ERSx
					33.0	20.33 (180)		2198-D032-ERSx
VPF-B1303C	2250	2250	6.30	8.80 (78.0)	17.60	19.83 (175)	1.74 (2.33)	2198-D012-ERSx
					18.47	20.72 (183)		2198-D020-ERSx
VPF-B1303F	4000	4000	10.10	8.80 (78.0)	28.20	19.85 (175)	2.54 (3.40)	2198-D020-ERSx
					31.0	20.72 (183)		2198-D032-ERSx
VPF-B1304C	2150	2150	7.0	10.29 (91.0)	17.60	22.55 (199)	1.49 (2.00)	2198-D012-ERSx
					22.3	28.45 (252)		2198-D020-ERSx
VPF-B1304E	3500	3500	9.44	10.29 (91.0)	28.20	25.03 (221)	2.40 (3.21)	2198-D020-ERSx
					33.76	28.45 (252)		2198-D032-ERSx
VPF-B1652C	2700	2700	16.0	19.40 (172)	45.90	44.78 (396)	4.18 (5.60)	2198-D032-ERSx
					49.88	48.60 (430)		2198-D057-ERSx

Performance specification data and curves reflect nominal system performance of a typical system with the motor ambient at 40 °C (104 °F), drive ambient at 50 °C (122 °F), and rated line voltage. For additional information on ambient and line conditions, refer to Motion Analyzer software.

Kinetix 5700 (400V-class) Drives/Kinetix VPF Servo Motor Curves

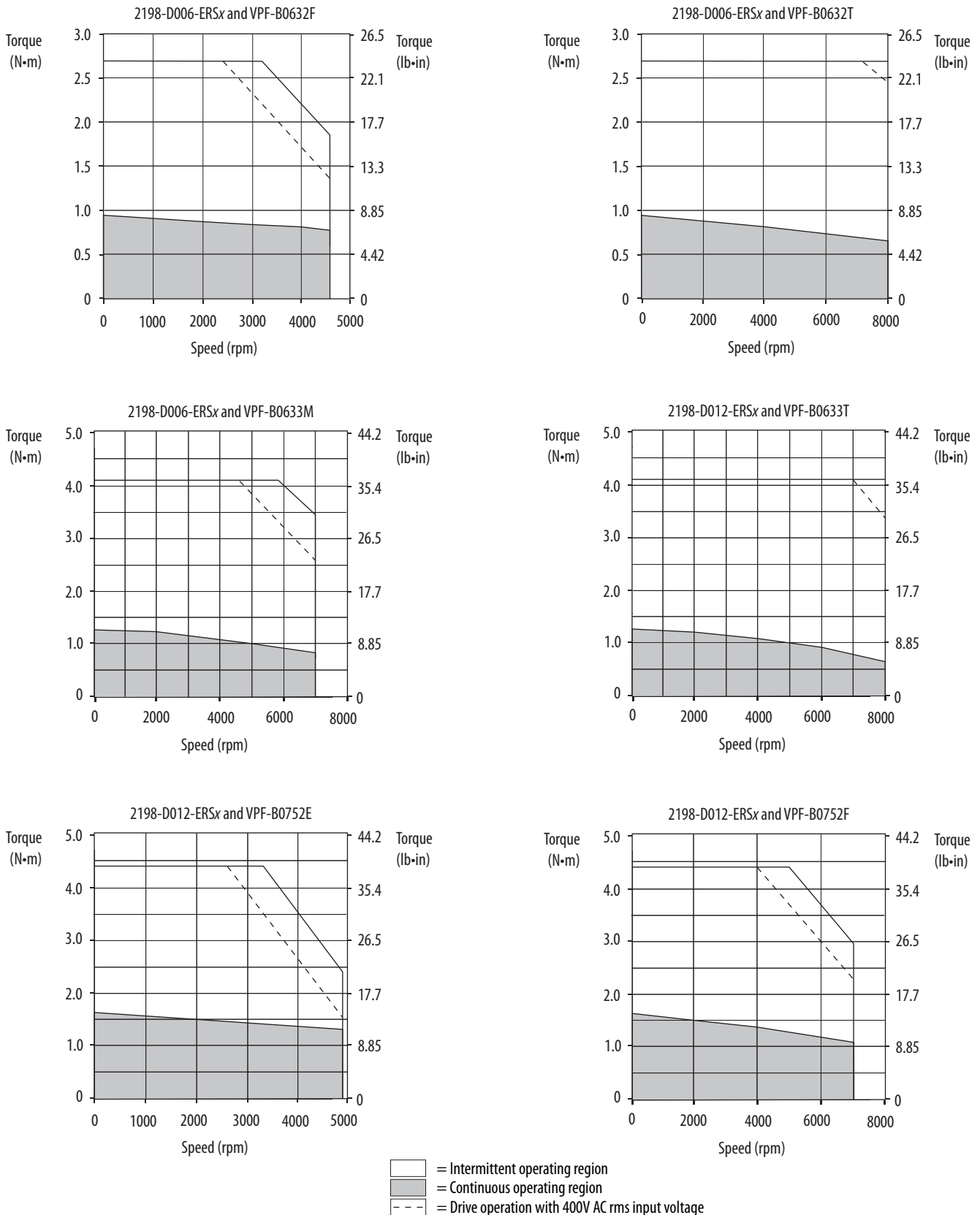

Kinetix 5700 (400V-class) Drives/Kinetix VPF Servo Motor Curves (continued)

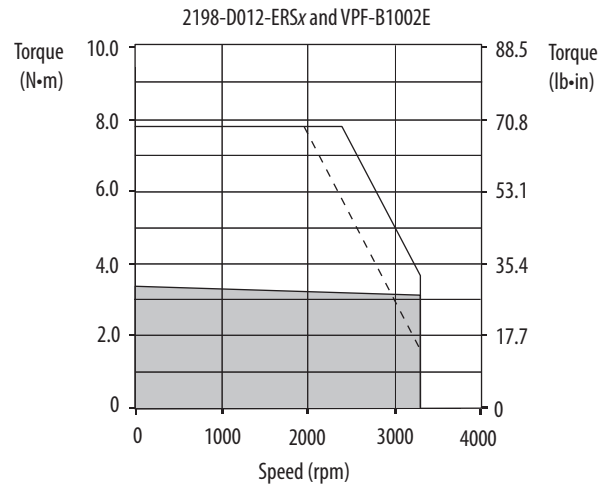
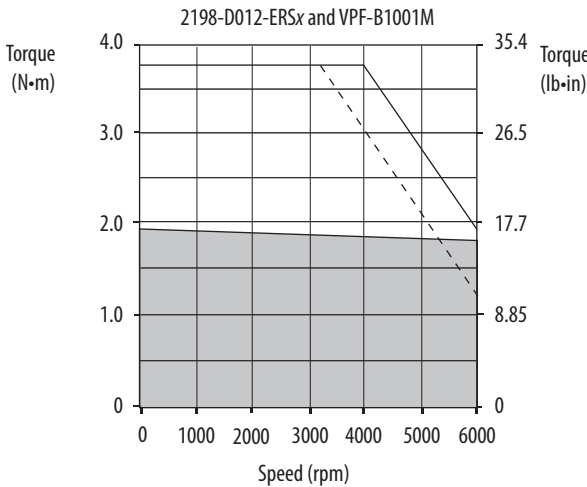
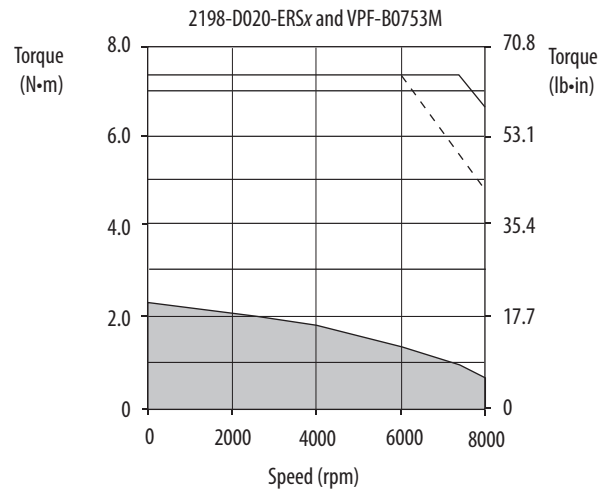
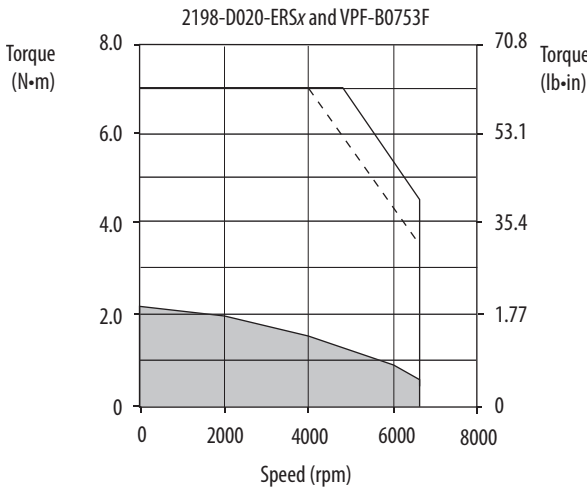
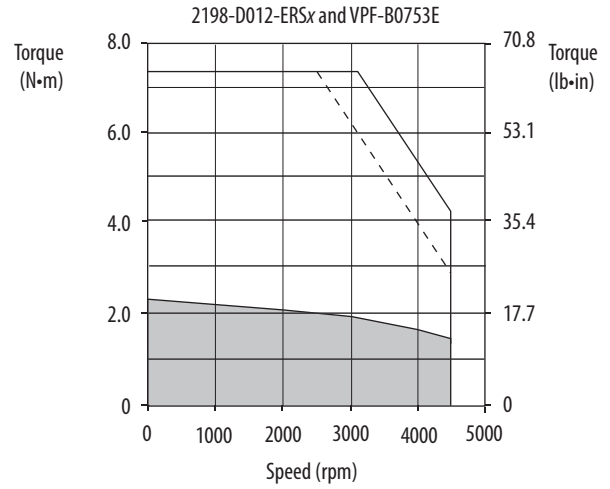
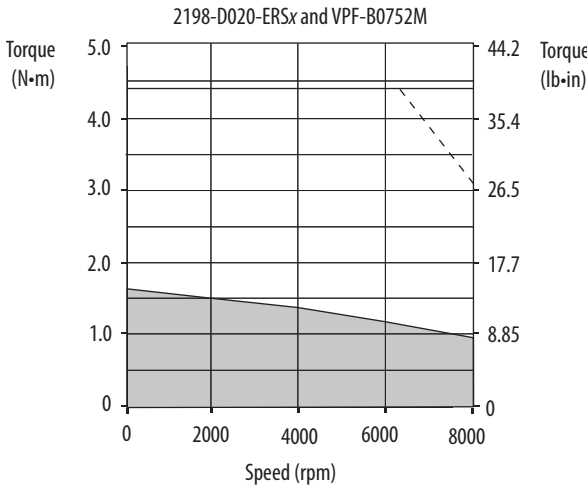

- = Intermittent operating region
- = Continuous operating region
- = Drive operation with 400V AC rms input voltage

Kinetix 5700 (400V-class) Drives/Kinetix VPF Servo Motor Curves (continued)

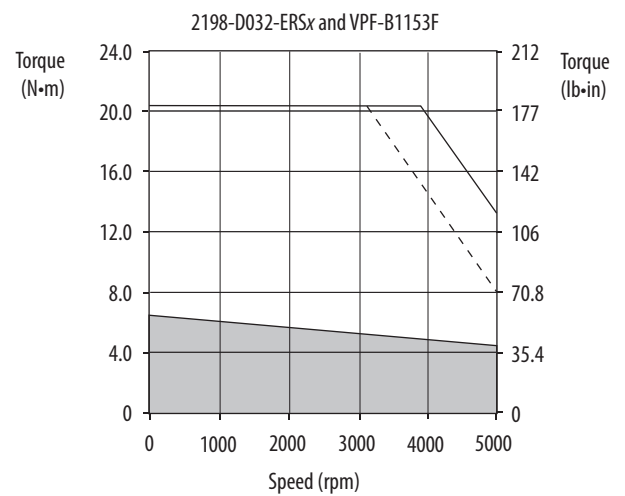
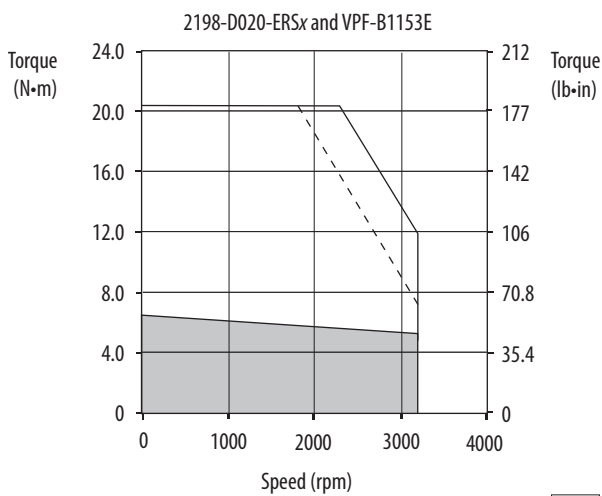
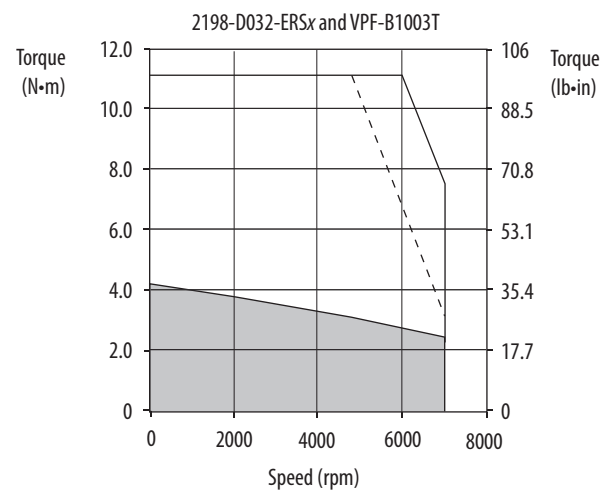
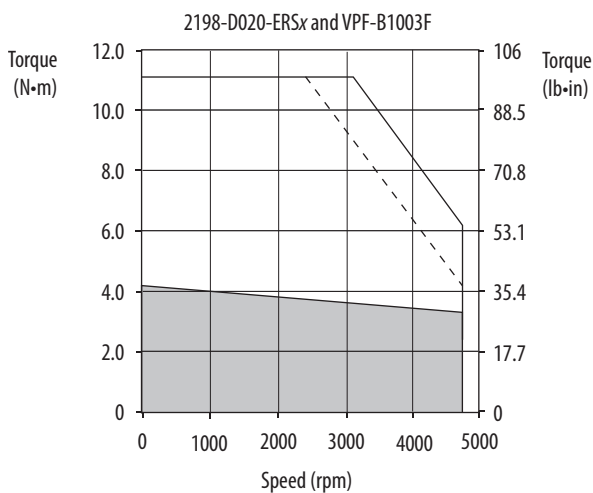
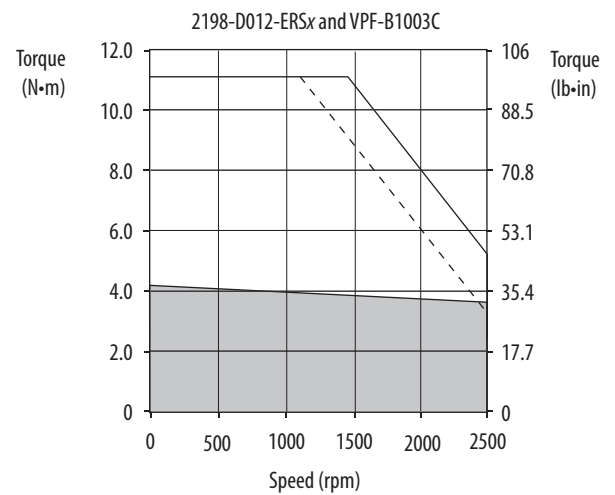
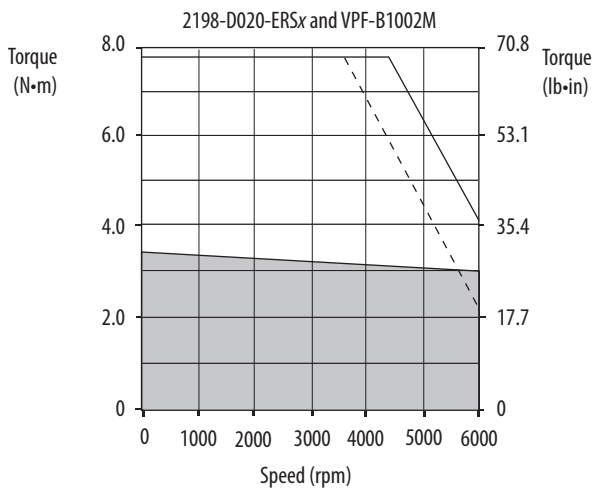

- = Intermittent operating region
- = Continuous operating region
- = Drive operation with 400V AC rms input voltage

Kinetix 5700 (400V-class) Drives/Kinetix VPF Servo Motor Curves (continued)

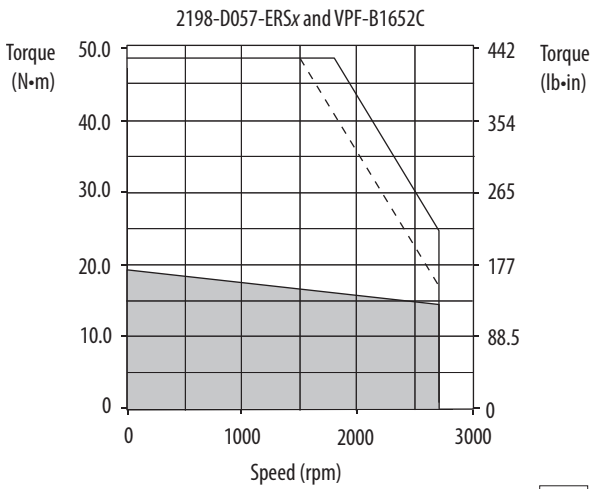
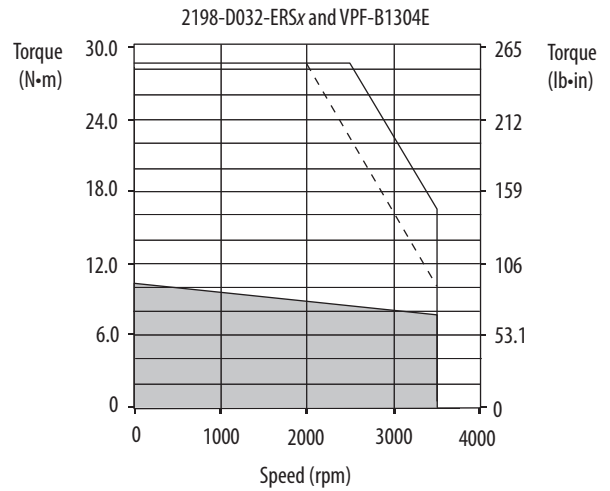
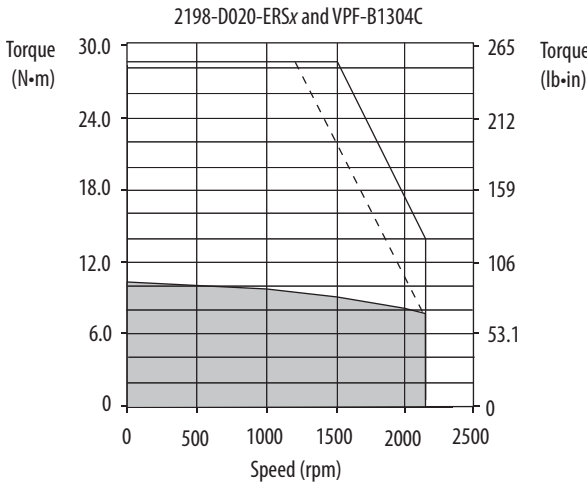
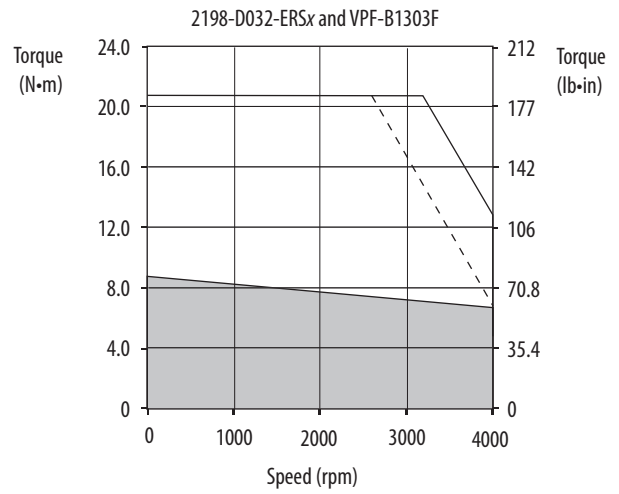
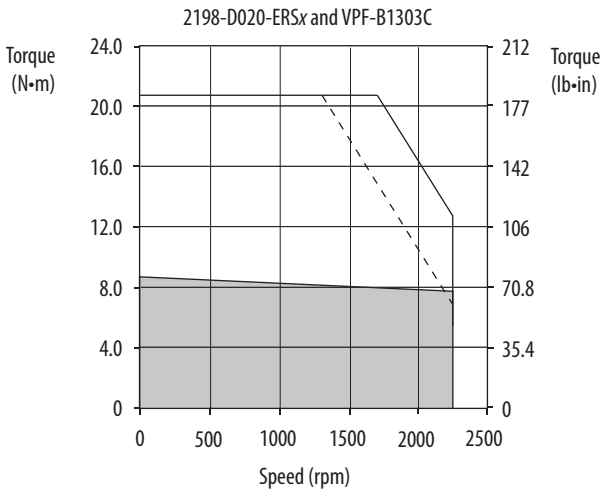

- = Intermittent operating region
- = Continuous operating region
- = Drive operation with 400V AC rms input voltage

Kinetix 5700 (400V-class) Drives with Kinetix VPH Hygienic Stainless-steel Motors

This section provides system combination information for the Kinetix 5700 drives (with 480V, nominal input) when matched with Kinetix VPH (400V-class) hygienic servo motors. Single-cable catalog numbers, system performance specifications, and the optimum torque/speed curves are included.

Kinetix VPH Motor Cable Combinations

Rotary Motor (400V-class) ⁽¹⁾ Cat. No.	Single Cable Cat. No. ⁽²⁾	Feedback Type
VPH-B0632T, VPH-B0633M	2090-CSBM1Dx-18xAxx or 2090-CSWM1Dx-18xAxx (standard, non-flex) 2090-CSBM1Dx-18xFxx (continuous-flex)	Single-turn or Absolute, Multi-turn Digital Encoder • SIL 2/PLd Rated • Hiperface DSL Protocol
VPH-B0753F		
VPH-B1001F, VPH-B1003F		
VPH-B1152F		
VPH-B1153E	2090-CSBM1Dx-14xAxx or 2090-CSWM1Dx-14xAxx (standard, non-flex) 2090-CSBM1Dx-14xFxx (continuous-flex)	
VPH-B1304E		
VPH-B1653D		

(1) The VPH-B100xx and VPH-B1152F frame on-motor cables include 14 AWG conductors and are also compatible with 2090-CSxM1Dx-14xxxx cable.

(2) Use 2090-CSxM1DE or 2090-CSxM1DG cables. Cable length xx is in meters, 01 (3.3) . . . 50 (164) in 1.0 m (3.3 ft) increments. For information on maximum cable lengths see Kinetix 5700 Servo Drives User Manual, publication [2198-UM002](#). Refer to the Kinetix Motion Accessories Technical Data, publication [KNX-TD004](#), for cable specifications. For cable configuration illustrations and feature descriptions, by catalog number, refer to 2090-Series Single Motor Cable Overview beginning on [page 18](#).

Kinetix VPH (non-brake) Motor Performance Specifications with Kinetix 5700 (400V-class) Drives

Rotary Motor Cat. No.	Rated Speed rpm	Maximum Speed rpm	System Continuous Stall Current A 0-pk	System Continuous Stall Torque N·m (lb·in)	System Peak Stall Current A 0-pk	System Peak Stall Torque N·m (lb·in)	Motor Rated Output kW (Hp)	Kinetix 5700 Drives (480V AC input)
VPH-B0632T-xxx2	8000	8000	2.44	0.84 (7.5)	8.75	2.69 (24.0)	0.52 (0.69)	2198-D006-ERSx
VPH-B0633M-xxx2	6700	6700	2.05	1.03 (9.2)	8.75	4.09 (36.0)	0.50 (0.67)	2198-D006-ERSx
VPH-B0753F-xxx2	6600	6600	3.68	1.87 (16.6)	17.60	6.54 (58.0)	0.74 (0.99)	2198-D012-ERSx
					18.90	7.02 (62.0)		2198-D020-ERSx
VPH-B1001F-xxx2	5000	5000	2.19	1.44 (12.8)	7.10	3.61 (32.0)	0.70 (0.93)	2198-D006-ERSx
VPH-B1003F-xxx2	4750	4750	4.93	3.43 (30.4)	17.60	9.71 (86.0)	1.36 (1.83)	2198-D012-ERSx
					20.20	11.15 (99.0)		2198-D020-ERSx
VPH-B1152F-xxx2	4500	4500	5.15	4.03 (35.7)	17.60	10.89 (96.4)	1.37 (1.84)	2198-D012-ERSx
					21.19	13.12 (116)		2198-D020-ERSx
VPH-B1153E-xxx2	3900	5000	7.09	5.13 (45.4)	17.60	10.84 (96.0)	1.27 (1.70)	2198-D012-ERSx
					33.00	20.33 (180)		2198-D032-ERSx
VPH-B1304E-xxx2	3500	3500	8.10	8.41 (74.5)	28.20	23.74 (210)	2.15 (2.88)	2198-D020-ERSx
					33.76	28.45 (252)		2198-D032-ERSx
VPH-B1653D-xxx2	3000	3000	14.72	18.67 (165)	45.90	45.77 (405)	3.16 (4.23)	2198-D032-ERSx
					68.0	67.80 (600)		2198-D057-ERSx

Performance specification data and curves reflect nominal system performance of a typical system with the motor ambient at 40 °C (104 °F), drive ambient at 50 °C (122 °F), and rated line voltage. For additional information on ambient and line conditions, refer to Motion Analyzer software.

Kinetix VPH (brake) Motor Performance Specifications with Kinetix 5700 (400V-class) Drives

Rotary Motor Cat. No.	Rated Speed rpm	Maximum Speed rpm	System Continuous Stall Current A 0-pk	System Continuous Stall Torque N-m (lb-in)	System Peak Stall Current A 0-pk	System Peak Stall Torque N-m (lb-in)	Motor Rated Output kW (Hp)	Kinetix 5700 Drives (480V AC input)
VPH-B0632T-xxx4	7200	8000	2.43	0.80 (7.1)	8.75	2.69 (24.0)	0.40 (0.54)	2198-D006-ERSx
VPH-B0633M-xxx4	6700	6700	1.97	1.01 (8.9)	8.75	4.09 (36.0)	0.50 (0.67)	2198-D006-ERSx
VPH-B0753F-xxx4	6600	6600	3.49	1.81 (16.0)	8.80	3.27 (28.9)	0.68 (0.92)	2198-D006-ERSx
					18.90	7.02 (62.0)		2198-D020-ERSx
VPH-B1001F-xxx4	5000	5000	2.20	1.42 (12.6)	7.10	3.61 (32.0)	0.68 (0.91)	2198-D006-ERSx
VPH-B1003F-xxx4	4750	4750	4.89	3.29 (29.1)	17.60	9.71 (86.0)	1.16 (1.56)	2198-D012-ERSx
					20.20	11.15 (99.0)		2198-D020-ERSx
VPH-B1152F-xxx4	4500	4500	5.15	4.03 (35.7)	17.60	10.89 (96.4)	1.37 (1.84)	2198-D012-ERSx
					21.19	13.12 (116)		2198-D020-ERSx
VPH-B1153E-xxx4	3900	5000	7.09	5.13 (45.4)	17.60	10.84 (96.0)	1.08 (1.45)	2198-D012-ERSx
					33.00	20.33 (180)		2198-D032-ERSx
VPH-B1304E-xxx4	3500	3500	8.27	8.24 (73.0)	28.20	23.74 (210)	1.76 (2.36)	2198-D020-ERSx
					33.76	28.45 (252)		2198-D032-ERSx
VPH-B1653D-xxx4	3000	3000	14.92	18.67 (165)	45.90	45.77 (405)	2.91 (3.91)	2198-D032-ERSx
					68.00	67.80 (600)		2198-D057-ERSx

Performance specification data and curves reflect nominal system performance of a typical system with the motor ambient at 40 °C (104 °F), drive ambient at 50 °C (122 °F), and rated line voltage. For additional information on ambient and line conditions, refer to Motion Analyzer software.

Kinetix 5700 (400V-class) Drives/Kinetix VPH Hygienic Servo Motor Curves

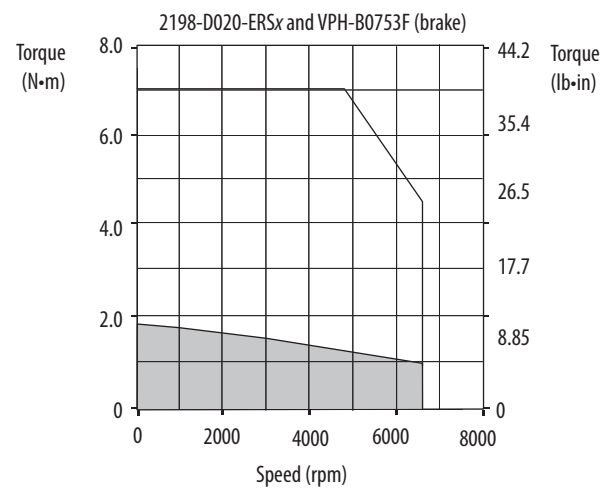
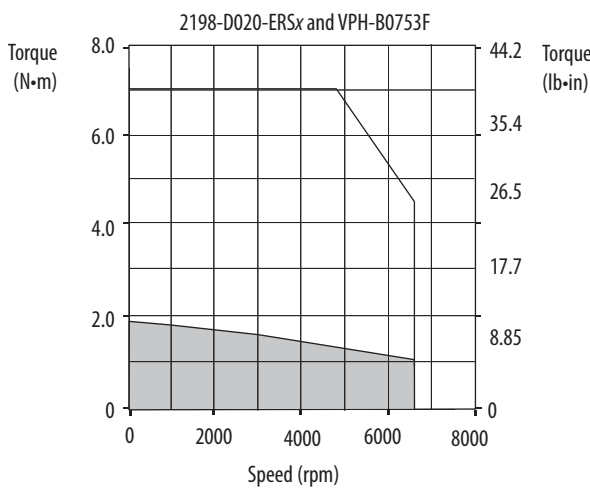
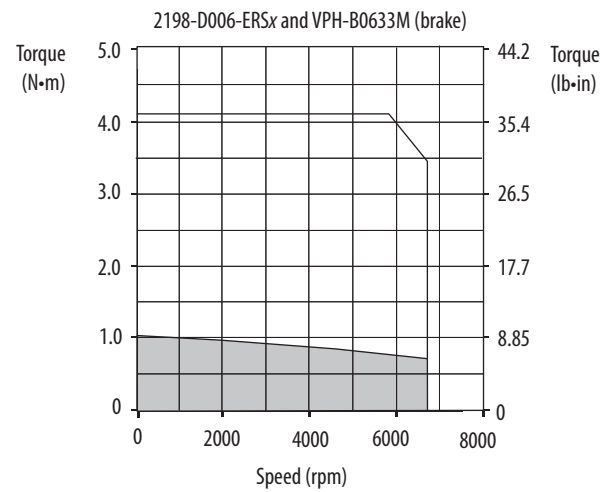
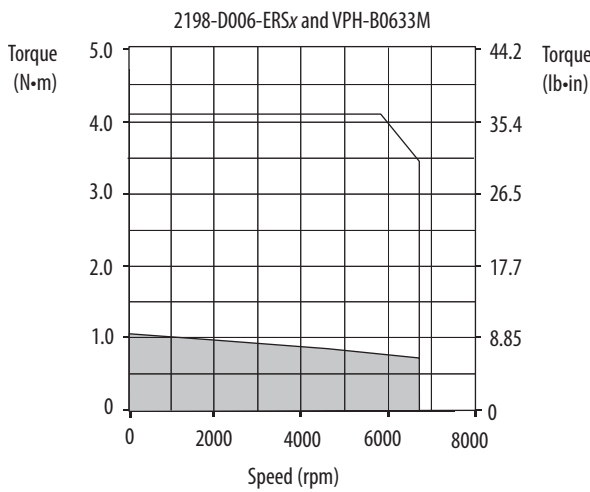
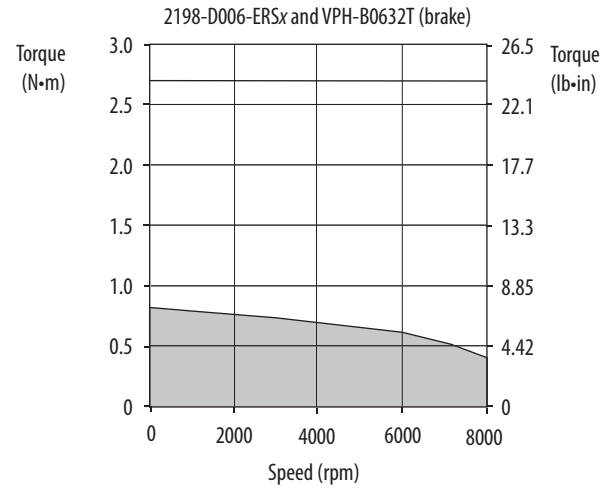
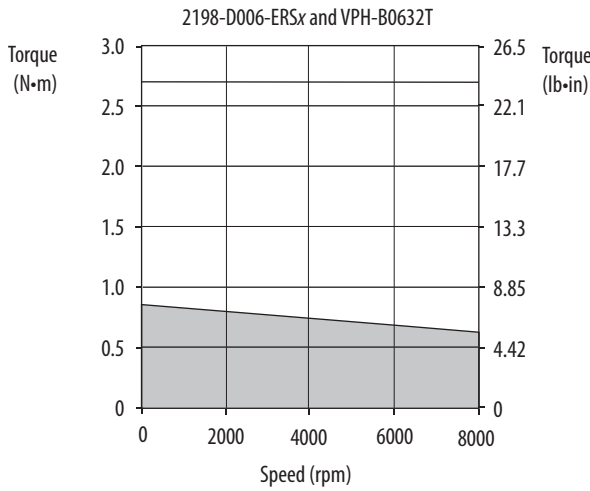

= Intermittent operating region
 = Continuous operating region

Kinetix 5700 (400V-class) Drives/Kinetix VPH Hygienic Servo Motor Curves (continued)

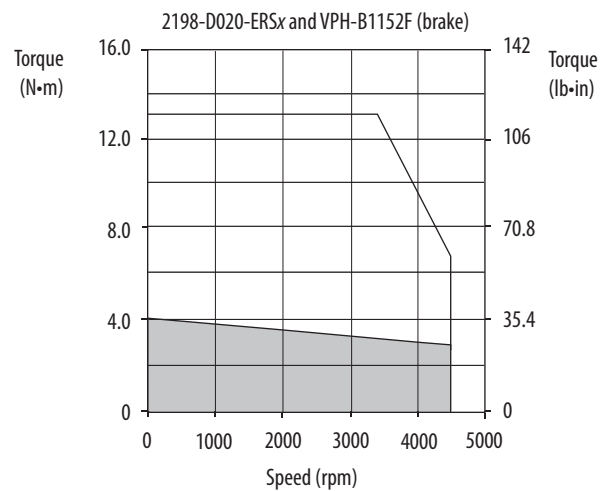
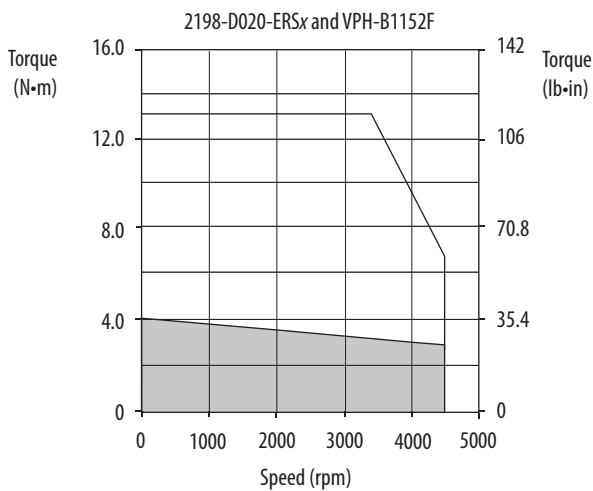
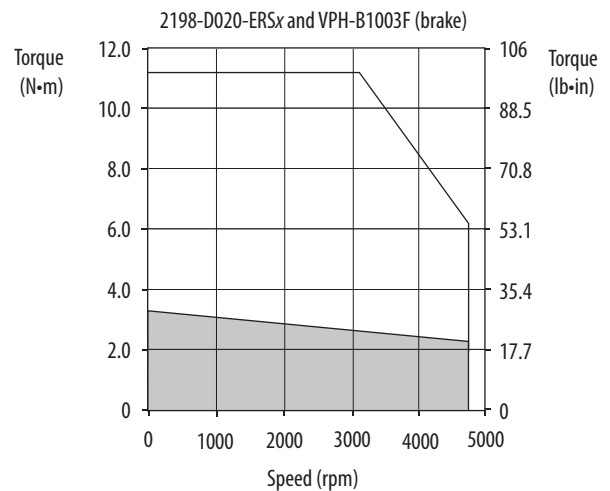
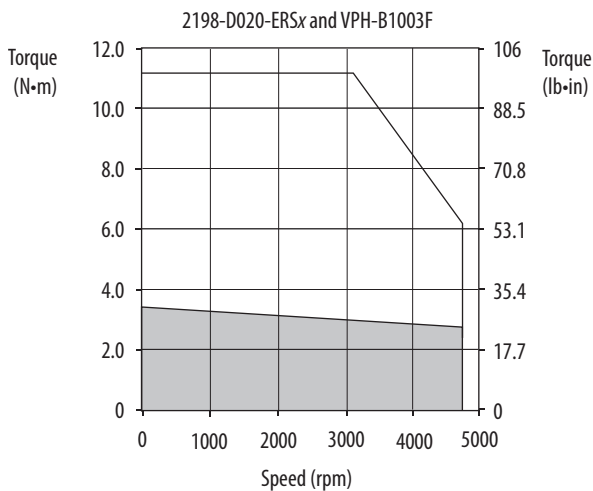
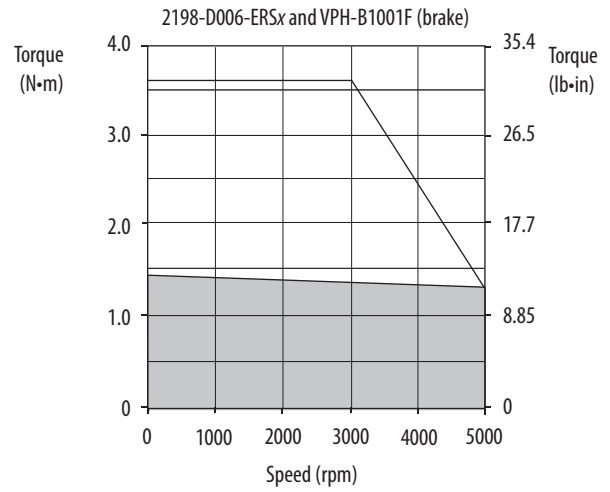
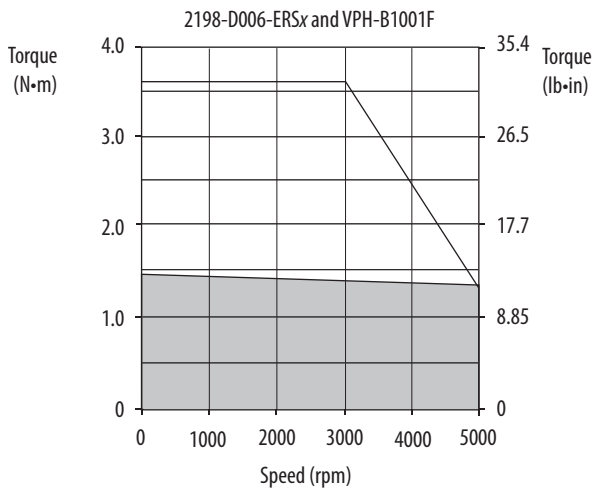

= Intermittent operating region
 = Continuous operating region

Kinetix 5700 (400V-class) Drives/Kinetix VPH Hygienic Servo Motor Curves (continued)

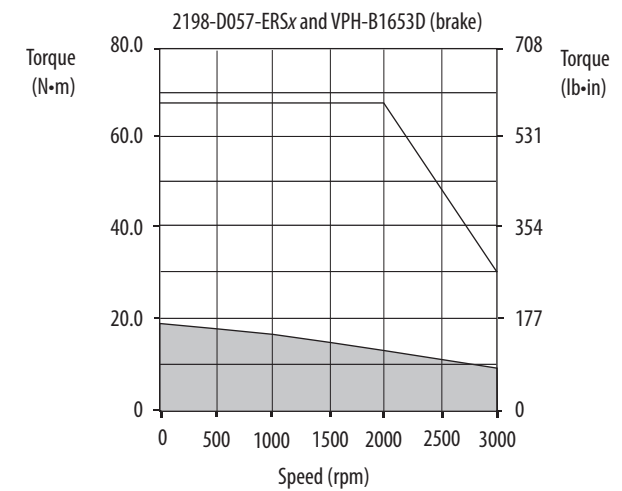
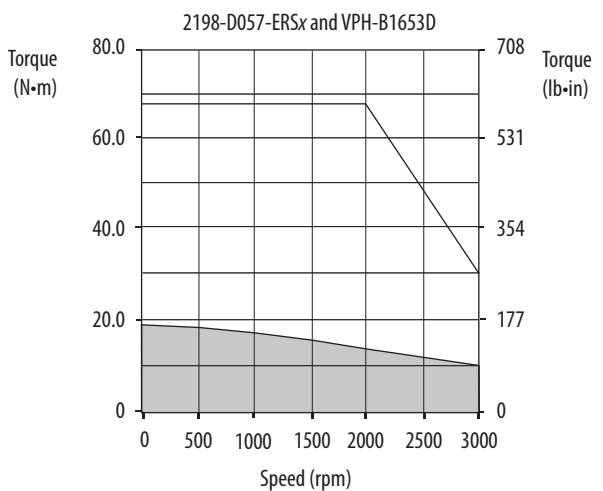
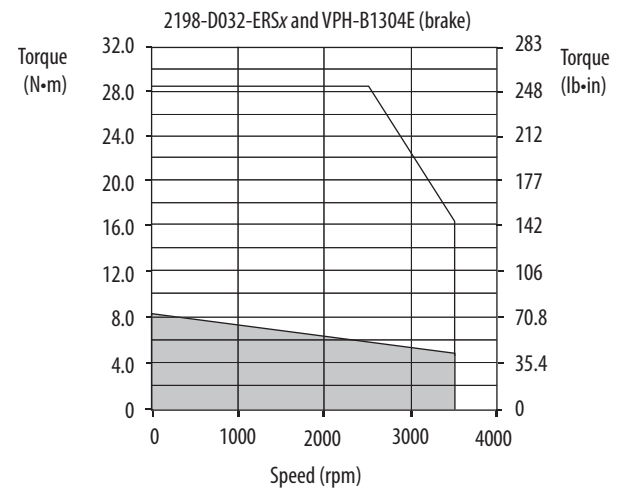
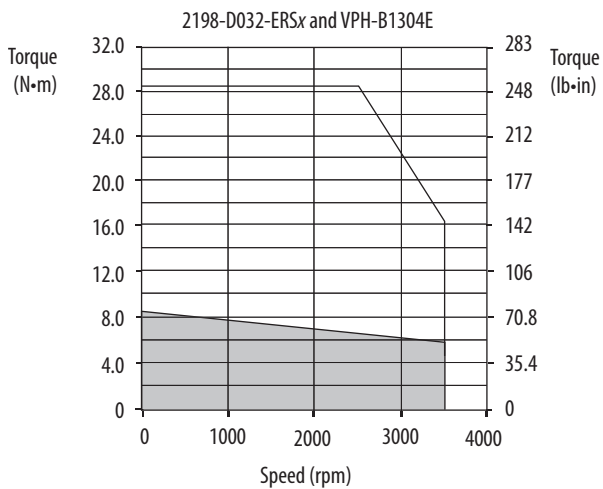
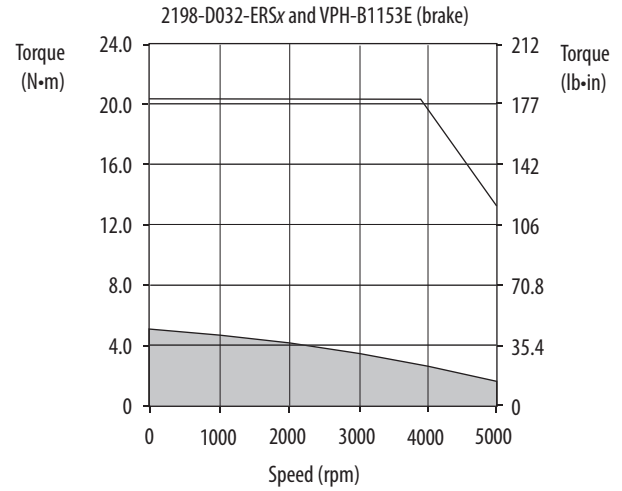
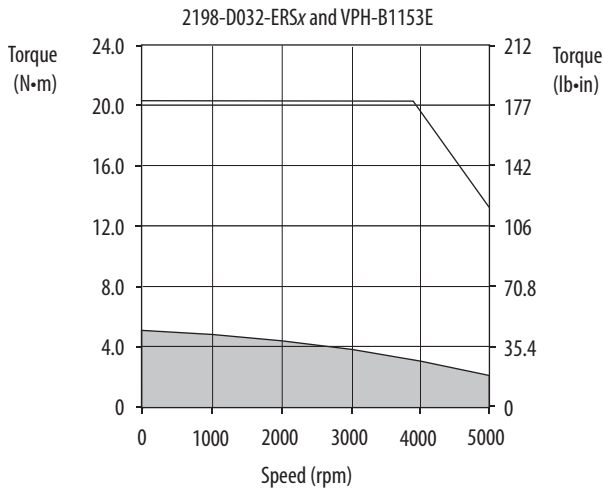

= Intermittent operating region
 = Continuous operating region

Kinetix 5700 (400V-class) Drives with Kinetix VPS Stainless-steel Motors

This section provides system combination information for the Kinetix 5700 drives (with 400 and 480V, nominal input) when matched with Kinetix VPS (400V-class) servo motors. Single-cable catalog numbers, system performance specifications, and the optimum torque/speed curves are included.

Kinetix VPS Motor Cable Combinations

Rotary Motor (400V-class) Cat. No.	Single Motor Cable ⁽¹⁾	Feedback Type
VPS-B1304D	2090-CSWM1Dx-14xAxx (standard, non-flex) 2090-CSBM1Dx-14xFxx (continuous-flex)	Absolute, Multi-turn Digital Encoder with Hiperface DSL Protocol
VPS-B1653D		

(1) Use 2090-CSxM1DE or 2090-CSxM1DG cables. Cable length xx is in meters, 01 (3.3) . . .50 (164) in 1.0 m (3.3 ft) increments. For information on maximum cable lengths see Kinetix 5700 Servo Drives User Manual, publication [2198-UM002](#). Refer to the Kinetix Motion Accessories Technical Data, publication [KNX-TD004](#), for cable specifications. For cable configuration illustrations and feature descriptions, by catalog number, refer to 2090-Series Single Motor Cable Overview beginning on [page 18](#).

Kinetix VPS Motor Performance Specifications with Kinetix 5700 (400V-class) Drives

Rotary Motor Cat. No.	Rated Speed rpm	Maximum Speed rpm	System Continuous Stall Current A (0-pk)	System Continuous Stall Torque N·m (lb·in)	System Peak Stall Current A 0-pk	System Peak Stall Torque N·m (lb·in)	Motor Rated Output kW (Hp)	Kinetix 5700 Drives (480V AC input)
VPS-B1304D	3000	3000	7.1	8.1 (72.0)	17.6	17.9 (158)	1.40 (1.9)	2198-D012-ERSx
					26.0	27.1 (240)		2198-D020-ERSx
VPS-B1653D	3000	3000	17.0	21.0 (186)	45.9	50.1 (443)	3.29 (4.4)	2198-D032-ERSx
					68.0	67.8 (600)		2198-D057-ERSx

Performance specification data and curves reflect nominal system performance of a typical system with the motor ambient at 40 °C (104 °F), drive ambient at 50 °C (122 °F), and rated line voltage. For additional information on ambient and line conditions, refer to Motion Analyzer software.

Kinetix 5700 (400V-class) Drives/Kinetix VPS Servo Motor Curves

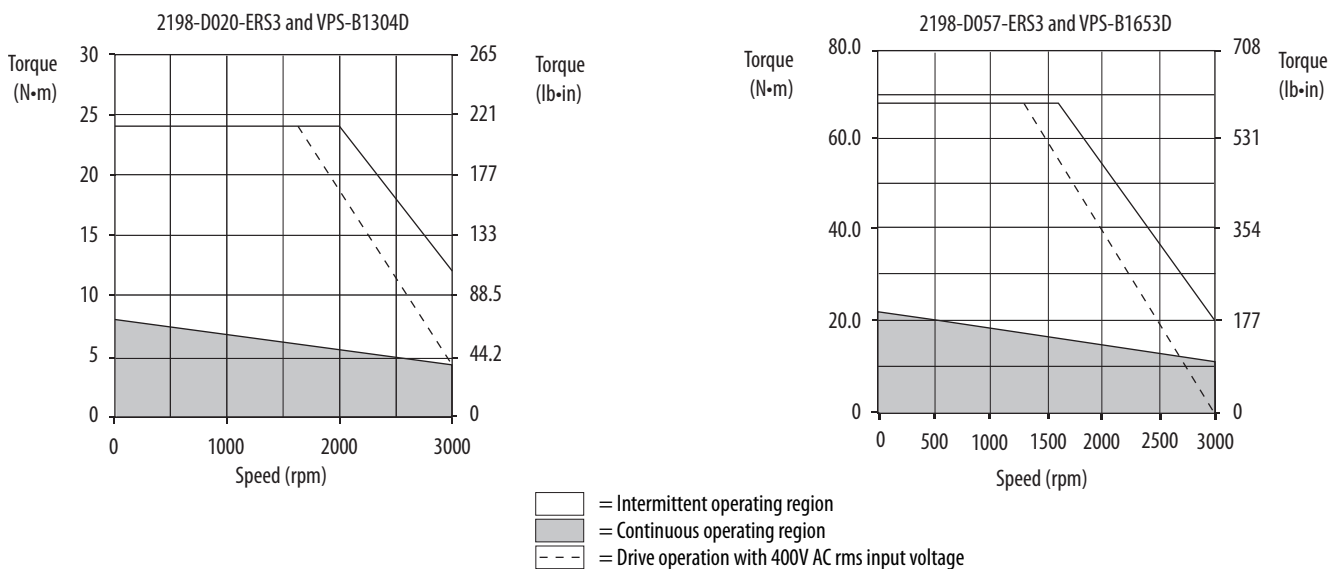

Kinetix 5700 (400V-class) Drives with Kinetix MPL Low-inertia Motors

This section provides system combination information for the Kinetix 5700 drives (with 400 and 480V, nominal input) when matched with Kinetix MPL (400V-class) servo motors with absolute high-resolution encoders. Included are motor power/brake and feedback cable catalog numbers, system performance specifications, and the optimum torque/speed curves.

IMPORTANT The Kinetix MPL servo motors on this page are equipped with DIN connectors (specified by 7, for example, MPL-B310P-xx7xAA) and are **not** compatible with cables designed for motors equipped with bayonet connectors (specified by 2, for example, MPL-B310P-xx2xAA). The motors with bayonet connectors are discontinued and require 2090-XXNxMP (bayonet) cables. For help with migration or to select bayonet transition cables, contact your Rockwell Automation sales representative.

Kinetix MPL Motor Cable Combinations

Rotary Motor (400V-class) Cat. No.	Motor Power/Brake Cable	Motor Feedback Cable ⁽¹⁾
MPL-B1510V-xx7xAA, MPL-B1520U-xx7xAA, MPL-B1530U-xx7xAA	2090-CPxM7DF-16AAxx (standard, non-flex) 2090-CPxM7DF-16AFxx (continuous-flex)	2090-CFBM7DF-CEAAxx ^{(2) (3)} (standard, non-flex) 2090-CFBM7DF-CEAFxx (continuous-flex) Absolute High-resolution Feedback
MPL-B210V-xx7xAA, MPL-B220T-xx7xAA, MPL-B230P-xx7xAA		
MPL-B310P-xx7xAA, MPL-B320P-xx7xAA, MPL-B330P-xx7xAA		
MPL-B420P-xx7xAA, MPL-B430P-xx7xAA		
MPL-B4530F-xx7xAA, MPL-B4530K-xx7xAA, MPL-B4540F-xx7xAA, MPL-B4560F-xx7xAA		
MPL-B520K-xx7xAA		
MPL-B540D-xx7xAA, MPL-B540K-xx7xAA, MPL-B560F-xx7xAA	2090-CPxM7DF-14AAxx (standard, non-flex) 2090-CPxM7DF-14AFxx (continuous-flex)	2090-XXNFMF-Sxx (standard) ⁽⁴⁾ 2090-CFBM7DF-CDAFxx (continuous-flex) Incremental Feedback
MPL-B580F-xx7xAA, MPL-B580J-xx7xAA	2090-CPxM7DF-10AAxx (standard, non-flex) 2090-CPxM7DF-10AFxx (continuous-flex)	
MPL-B640F-xx7xAA ⁽⁵⁾	2090-CPxM7DF-08AAxx (standard, non-flex) 2090-CPxM7DF-08AFxx (continuous-flex)	2090-XXNFMF-Sxx (standard) ⁽⁴⁾ 2090-CFBM7DF-CDAFxx (continuous-flex) Incremental Feedback
MPL-B660F-xx7xAA, MPL-B680D-xx7xAA, ⁽⁵⁾ MPL-B960B-xx7xAA, MPL-B980B-xx7xAA ⁽⁵⁾		
MPL-B680F-xx7xAA, MPL-B680H-xx7xAA, MPL-B860D-xx7xAA	2090-CPBM7DF-06AAxx (standard, non-flex)	2090-XXNFMF-Sxx (standard) ⁽⁴⁾ 2090-CFBM7DF-CDAFxx (continuous-flex) Incremental Feedback
MPL-B880C-xx7xAA		
MPL-B880D-xx7xAA	2090-CPBM7DF-04AAxx (standard, non-flex)	2090-XXNFMF-Sxx (standard) ⁽⁴⁾ 2090-CFBM7DF-CDAFxx (continuous-flex) Incremental Feedback
MPL-B960C-xx7xAA, MPL-B960D-xx7xAA, MPL-B980C-xx7xAA, MPL-B980D-xx7xAA		
MPL-B980E-xx7xAA		

(1) Use the 2198-K57CK-D15M feedback connector kit or 2198-H2DCK Hiperface-to-DSL converter kit with flying-lead cables on the drive end. Refer to Determine What You Need on [page 10](#).

(2) Applies to Kinetix 5700 drives and MPL-B3xxx-M/S through MPL-B9xxx-M/S motors with absolute high-resolution feedback.

(3) Applies to Kinetix 5700 drives and MPL-B15xxx-V/E through MPL-B2xxx-V/E motors with absolute high-resolution feedback.

(4) Applies to Kinetix 5700 drives and MPL-B15xxx-H through MPL-B45xxx-H motors with incremental feedback.

(5) For applications that use these five motors (catalog numbers MPL-Bxxxx-xx74AA with the brake option) where the power cable length exceeds 50 m (164 ft), 2090-CPBM7DF-06AAxx (6 AWG) cable is required. Motors without the brake option (catalog numbers MPL-Bxxxx-xx72AA) can use the cable size as specified in the table regardless of cable length.

For cable configuration illustrations and feature descriptions, by catalog number, refer to 2090-Series Motor Power/Brake and Feedback Cables Overview beginning on [page 19](#).

Motor-end connector kits are available for motor power/brake and feedback cables. Refer to the Kinetix Motion Accessories Technical Data, publication [KNX-TD004](#), for connector kit catalog numbers and cable specifications. Cable length xx is in meters. For information on maximum cable lengths see Kinetix 5700 Servo Drives User Manual, publication [2198-UM002](#).

Kinetix MPL Motor Performance Specifications with Kinetix 5700 (400V-class) Drives

Rotary Motor Cat. No.	Rated Speed rpm	Maximum Speed rpm	System Continuous Stall Current A 0-pk	System Continuous Stall Torque N·m (lb·in)	System Peak Stall Current A 0-pk	System Peak Stall Torque N·m (lb·in)	Motor Rated Output kW	Kinetix 5700 (480V AC input)
MPL-B1510V	8000	8000	0.95	0.26 (2.3)	3.10	0.77 (6.8)	0.16	2198-D006-ERSx
MPL-B1520U	7000	7000	1.80	0.49 (4.3)	6.10	1.58 (13.9)	0.27	2198-D006-ERSx
MPL-B1530U	7000	7000	2.0	0.90 (8.0)	7.20	2.82 (24.9)	0.39	2198-D006-ERSx
MPL-B210V	8000	8000	1.75	0.55 (4.9)	5.80	1.52 (13.4)	0.37	2198-D006-ERSx
MPL-B220T	6000	6000	3.30	1.61 (14.2)	8.80	3.67 (32.5)	0.62	2198-D006-ERSx
					11.3	4.74 (41.9)		2198-D012-ERSx
MPL-B230P	5000	5000	2.60	2.10 (18.6)	8.80	6.39 (56.6)	0.86	2198-D006-ERSx
					11.3	8.20 (73.0)		2198-D012-ERSx
MPL-B310P	5000	5000	2.4	1.6 (14.1)	7.10	3.6 (32)	0.77	2198-D006-ERSx
MPL-B320P	5000	5000	4.5	3.10 (27)	14.0	8.2 (72.5)	1.5	2198-D012-ERSx
MPL-B330P	5000	5000	6.1	4.18 (37)	17.6	10.4 (92.0)	1.8	2198-D012-ERSx
					19.0	11.1 (98)		2198-D020-ERSx
MPL-B420P	5000	5000	6.3	4.74 (42)	17.6	11.3 (100)	1.9	2198-D012-ERSx
					22.0	13.5 (119)		2198-D020-ERSx
MPL-B430P	5000	5000	9.2	6.55 (58)	28.2	17.6 (156)	2.2	2198-D020-ERSx
					32.0	19.8 (175)		2198-D032-ERSx
MPL-B4530F	3000	3000	6.7	8.36 (74)	17.6	17.7 (157)	2.1	2198-D012-ERSx
					21.0	20.3 (180)		2198-D020-ERSx
MPL-B4530K	4000	4000	9.9	8.25 (73)	28.2	18.7 (166)	2.6	2198-D020-ERSx
					31.0	20.3 (179)		2198-D032-ERSx
MPL-B4540F	3000	3000	9.1	10.20 (90)	28.2	26.2 (232)	2.6	2198-D020-ERSx
					29.0	27.1 (240)		2198-D032-ERSx
MPL-B4560F	3000	3000	11.3	13.85 (123)	28.2	28.4 (251)	3.2	2198-D020-ERSx
			11.8	14.0 (124)	36.0	34.4 (304)		2198-D032-ERSx
MPL-B520K	3500	4000	11.3	10.4 (92)	28.2	20.6 (182)	3.5	2198-D020-ERSx
			11.5	10.7 (95)	33.0	23.2 (205)		2198-D032-ERSx
MPL-B540D	2000	2000	10.5	19.4 (172)	23.0	41.0 (362)	3.4	2198-D020-ERSx
MPL-B540K	4000	4000	20.5	19.4 (172)	60.0	48.6 (430)	5.4	2198-D057-ERSx
MPL-B560F	3000	3000	20.6	26.8 (237)	68.0	67.8 (600)	5.5	2198-D057-ERSx
MPL-B580F	3000	3000	26.0	34.0 (301)	81.3	81.0 (717)	7.1	2198-D057-ERSx
					94.0	87.0 (770)		2198-S086-ERSx
MPL-B580J	3800	3800	32.0	34.0 (301)	81.3	73.0 (646)	7.9	2198-D057-ERSx
					94.0	81.0 (717)		2198-S086-ERSx
MPL-B640F	2000	3000	32.1	36.7 (325)	65.0	72.3 (640)	6.1	2198-D057-ERSx
MPL-B660F	2000	3000	38.5	48.0 (425)	96.0	101.1 (895)	6.1	2198-S086-ERSx
MPL-B680D	2000	2000	34.0	62.8 (556)	94.0	154.2 (1365)	9.3	2198-S086-ERSx
MPL-B680F	2000	3000	48.0	60.0 (531)	96.0	108.5 (960)	7.5	2198-S086-ERSx
MPL-B680H	2000	3500	51.0	60.0 (531)	121.6	130 (1150)	7.5	2198-S086-ERSx
					140	146.9 (1300)		2198-S130-ERSx
MPL-B860D	2000	2000	47.5	83.0 (735)	95.5	152.5 (1350)	12.5	2198-S086-ERSx
MPL-B880C	1500	1500	47.5	110 (973)	97.5	203 (1797)	12.6	2198-S086-ERSx
MPL-B880D	2000	2000	67.0	110 (973)	96.0	147 (1301)	12.6	2198-S130-ERSx

Kinetix MPL Motor Performance Specifications with Kinetix 5700 (400V-class) Drives (continued)

Rotary Motor Cat. No.	Rated Speed rpm	Maximum Speed rpm	System Continuous Stall Current A 0-pk	System Continuous Stall Torque N·m (lb·in)	System Peak Stall Current A 0-pk	System Peak Stall Torque N·m (lb·in)	Motor Rated Output kW	Kinetix 5700 (480V AC input)
MPL-B960B	1200	1200	42.5	130 (1150)	94.0	231 (2044)	12.7	2198-S086-ERSx
MPL-B960C	1500	1500	55.0	124.3 (1100)	121.6	219.8 (1945)	14.8	2198-S086-ERSx
					125	226 (2000)		2198-S130-ERSx
MPL-B960D	2000	2000	70.0	124.3 (1100)	125	226 (2000)	15.0	2198-S130-ERSx
MPL-B980B	1000	1000	40.0	162.7 (1444)	94.0	278 (2460)	15.2	2198-S086-ERSx
MPL-B980C	1500	1500	68.2	158.2 (1400)	140	271.2 (2400)	16.8	2198-S130-ERSx
MPL-B980D	2000	2000	79.0	158.2 (1400)	140	260 (2300)	18.6	2198-S130-ERSx
MPL-B980E	1500	2750	105	141 (1250)	226.2	233 (2062)	13.0	2198-S160-ERSx
					230	237 (2100)		2198-S263-ERSx

Performance specification data and curves reflect nominal system performance of a typical system with the motor ambient at 40 °C (104 °F), drive ambient at 50 °C (122 °F), and rated line voltage. For additional information on ambient and line conditions, refer to Motion Analyzer software.

Kinetix 5700 (400V-class) Drives/Kinetix MPL Servo Motor Curves

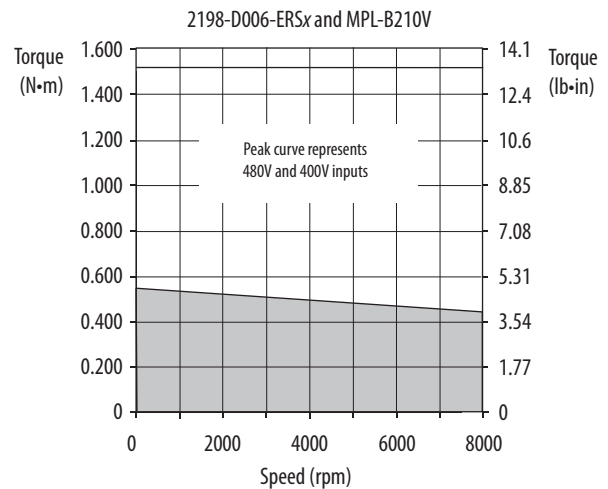
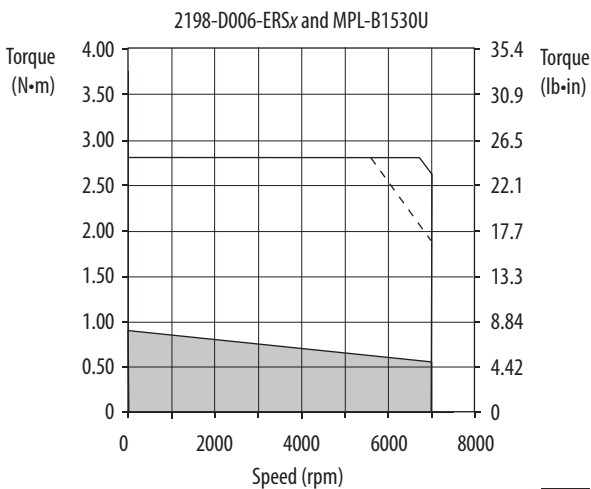
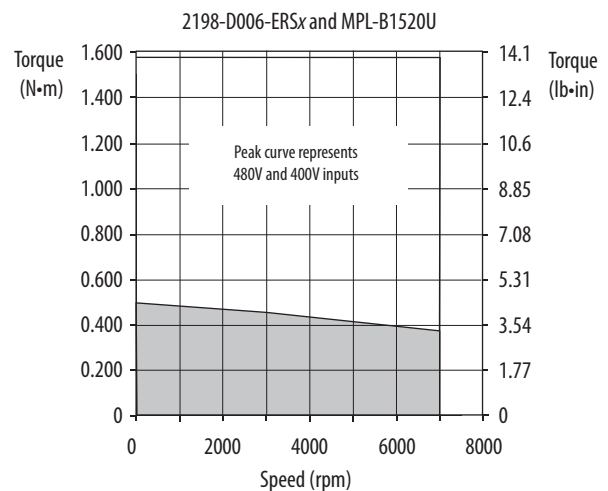
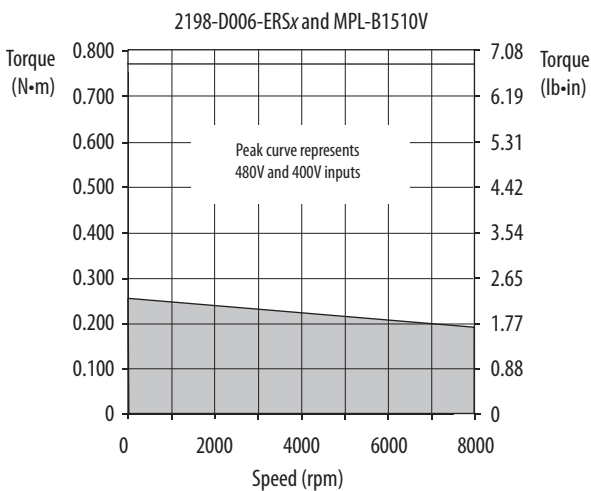

- = Intermittent operating region
- = Continuous operating region
- = Drive operation with 400V AC rms input voltage

Kinetix 5700 (400V-class) Drives/Kinetix MPL Servo Motor Curves (continued)

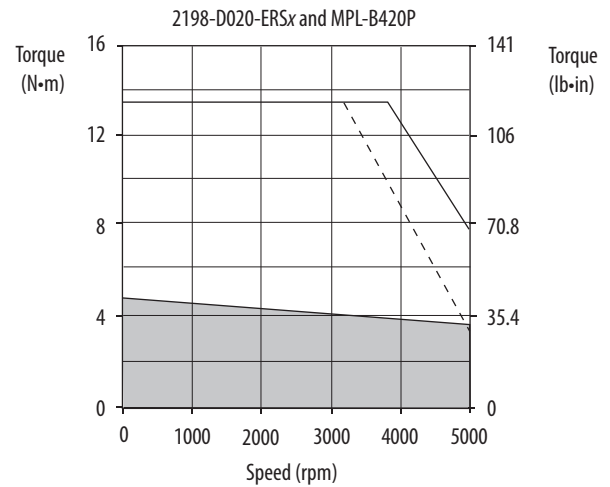
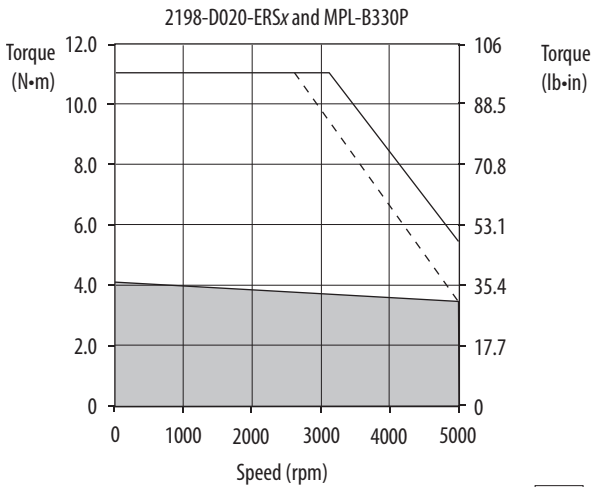
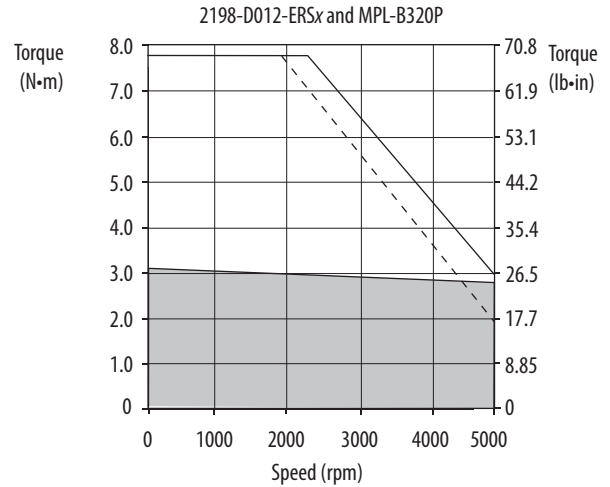
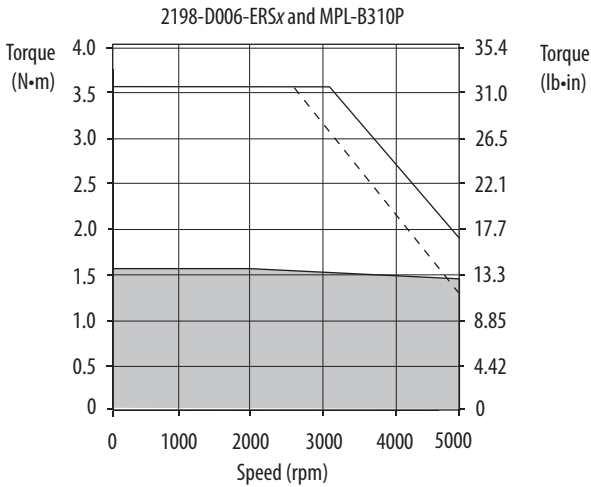
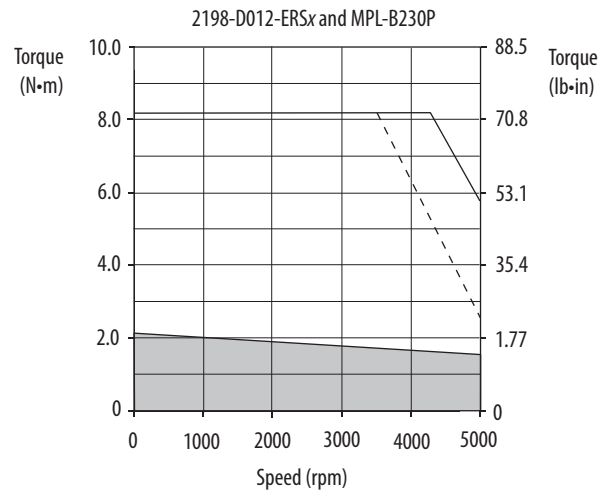
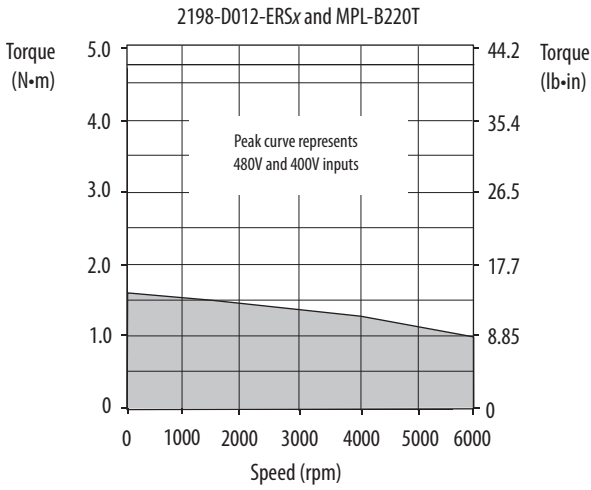

- = Intermittent operating region
- = Continuous operating region
- = Drive operation with 400V AC rms input voltage

Kinetix 5700 (400V-class) Drives/Kinetix MPL Servo Motor Curves (continued)

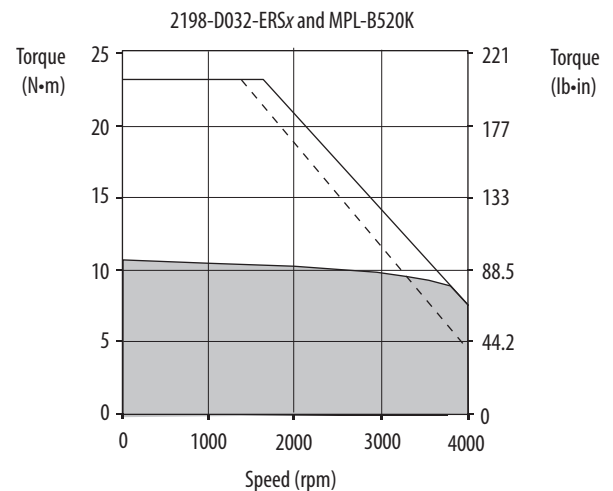
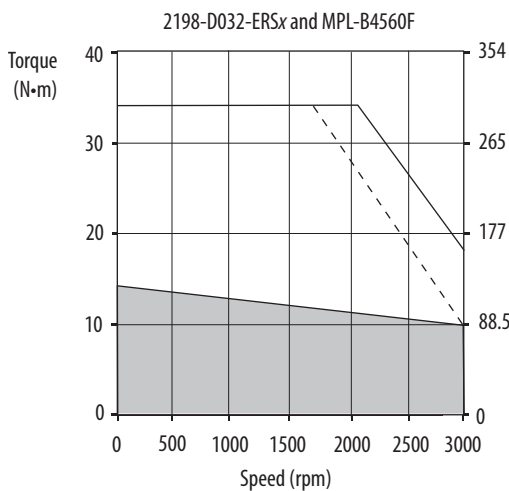
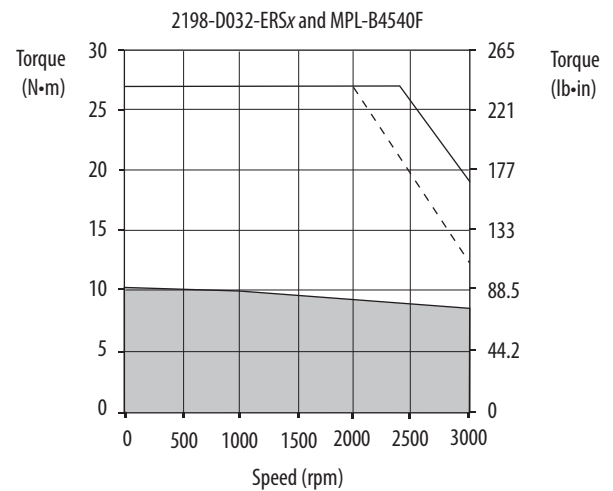
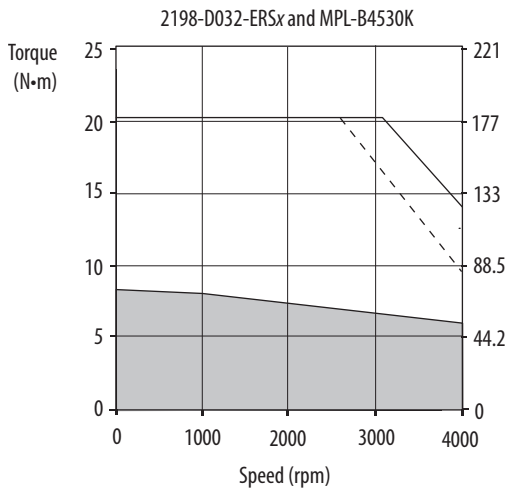
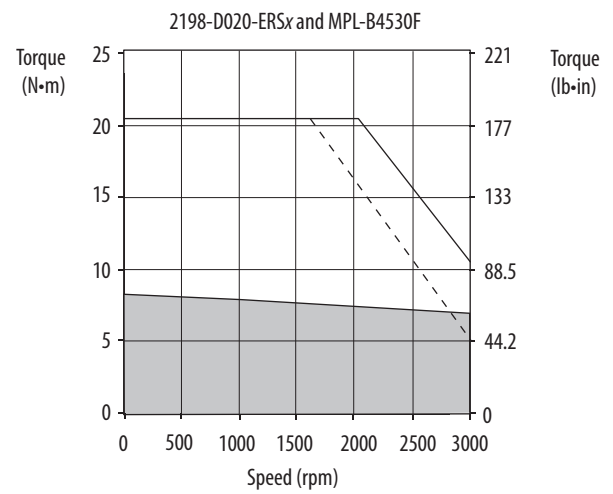
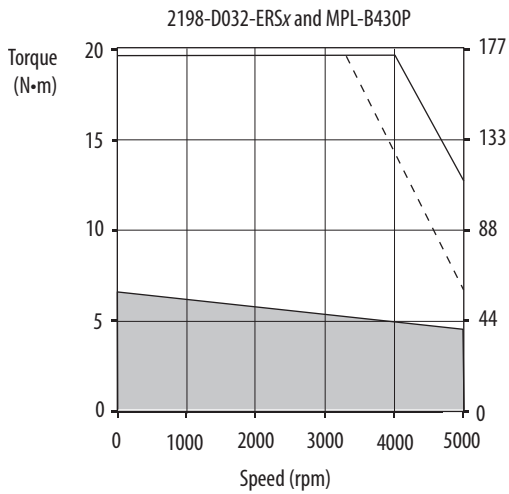

- = Intermittent operating region
- = Continuous operating region
- = Drive operation with 400V AC rms input voltage

Kinetix 5700 (400V-class) Drives/Kinetix MPL Servo Motor Curves (continued)

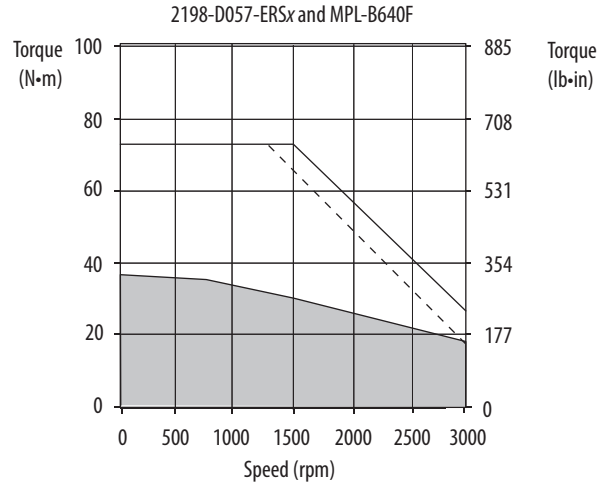
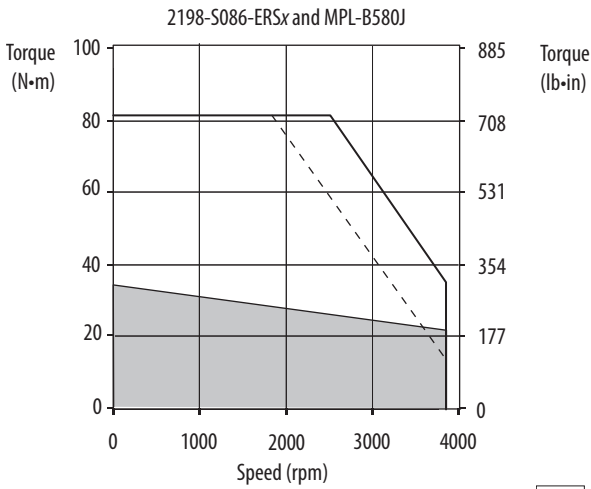
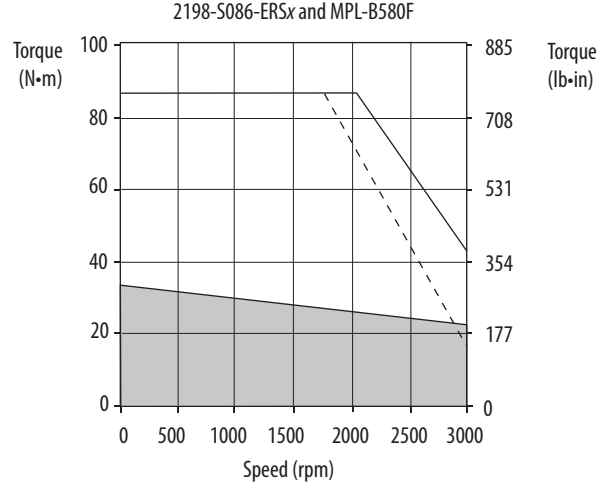
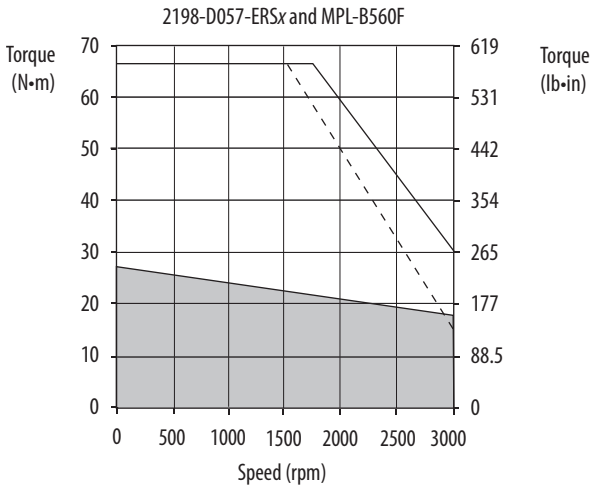
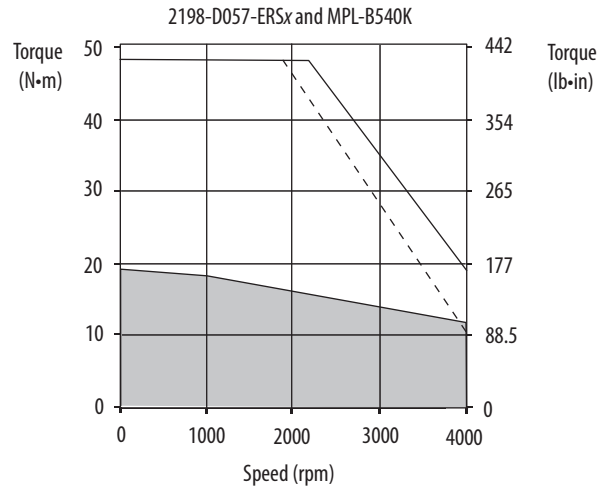
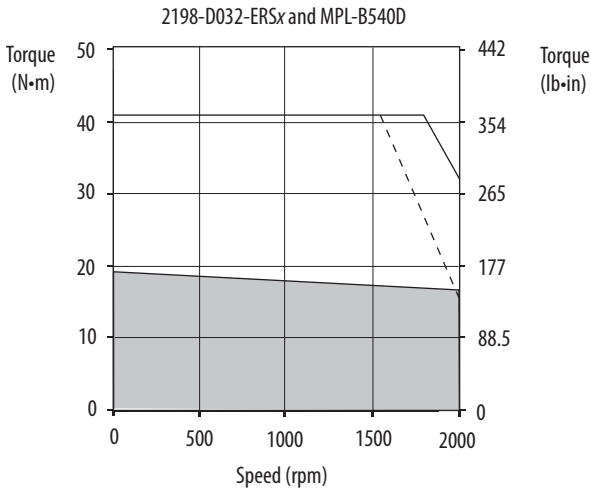

= Intermittent operating region
 = Continuous operating region
 = Drive operation with 400V AC rms input voltage

Kinetix 5700 (400V-class) Drives/Kinetix MPL Servo Motor Curves (continued)

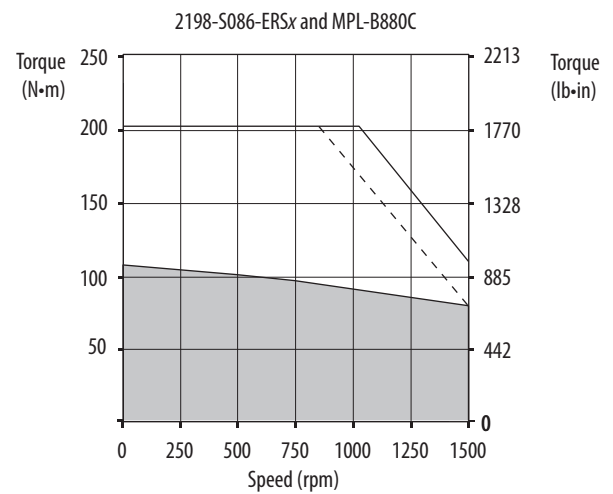
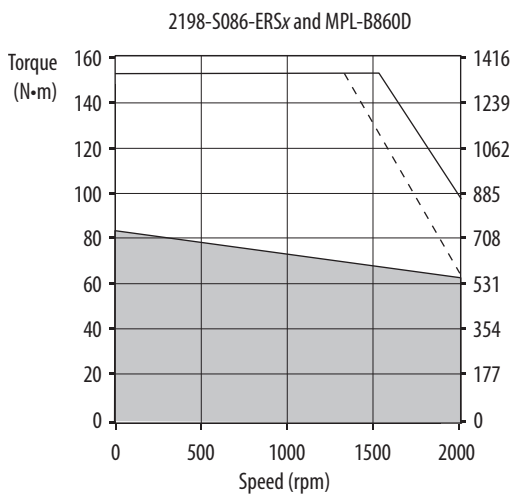
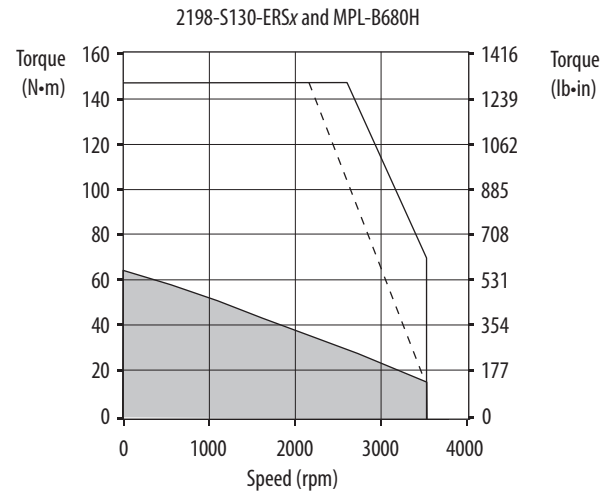
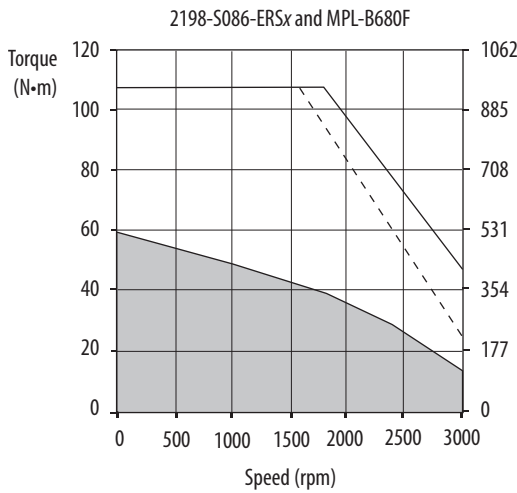
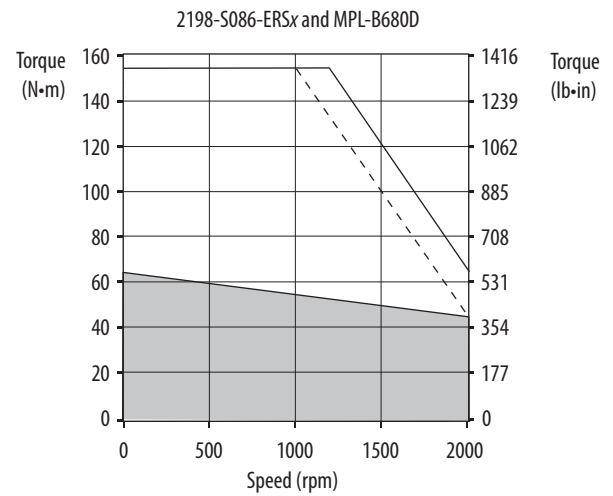
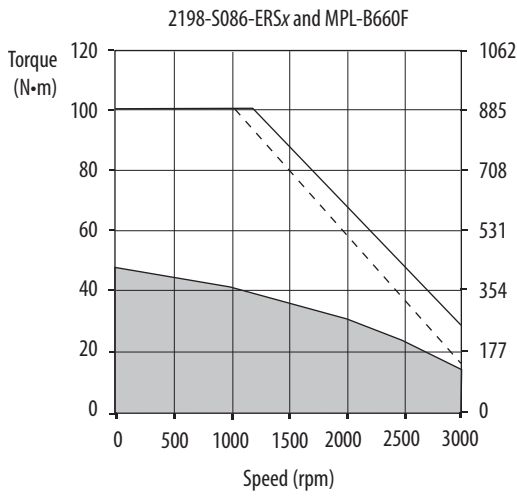

- = Intermittent operating region
- = Continuous operating region
- = Drive operation with 400V AC rms input voltage

Kinetix 5700 (400V-class) Drives/Kinetix MPL Servo Motor Curves (continued)

2198-S130-ERSx and MPL-B880D

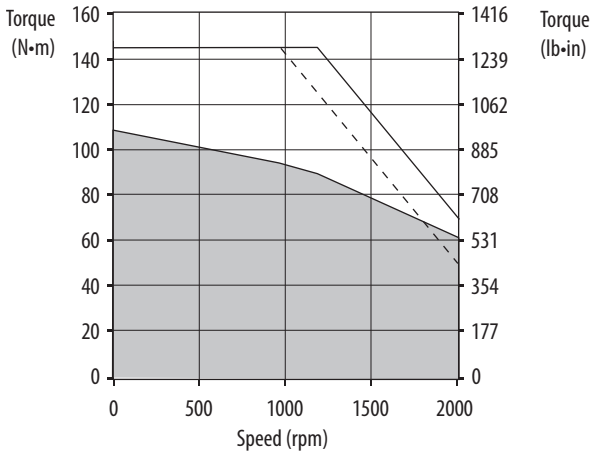

2198-S086-ERSx and MPL-B960B

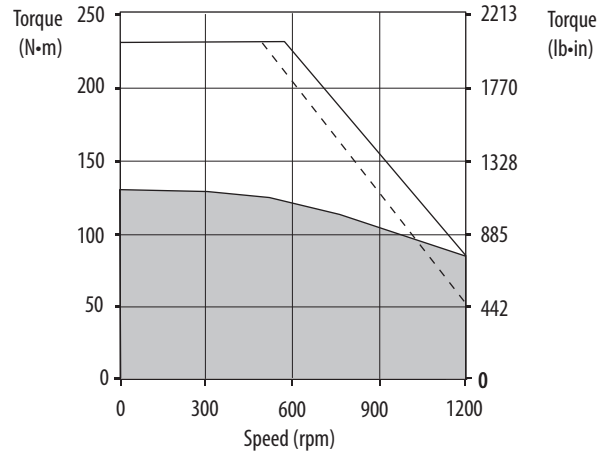

2198-S130-ERSx and MPL-B960C

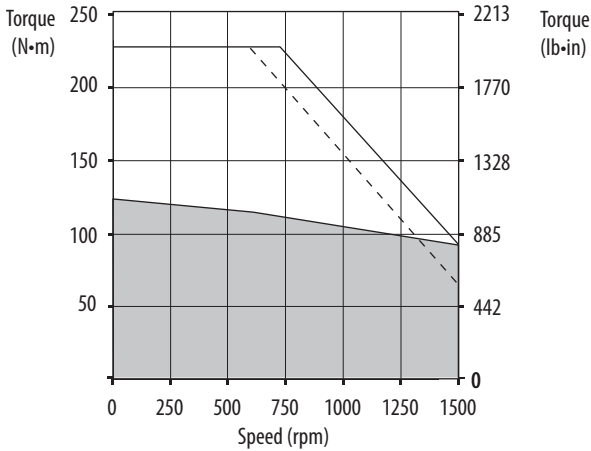

2198-S130-ERSx and MPL-B960D

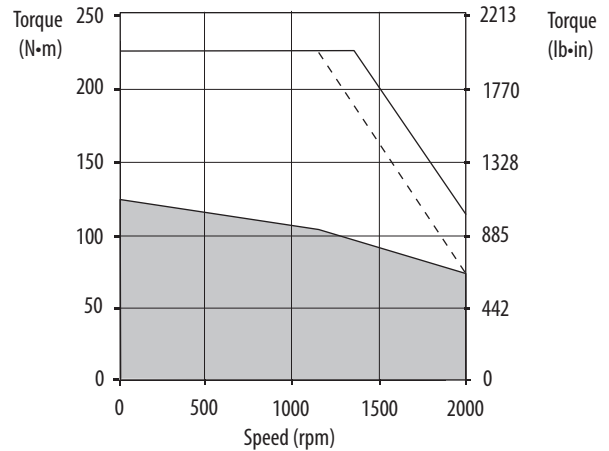

2198-S086-ERSx and MPL-B980B

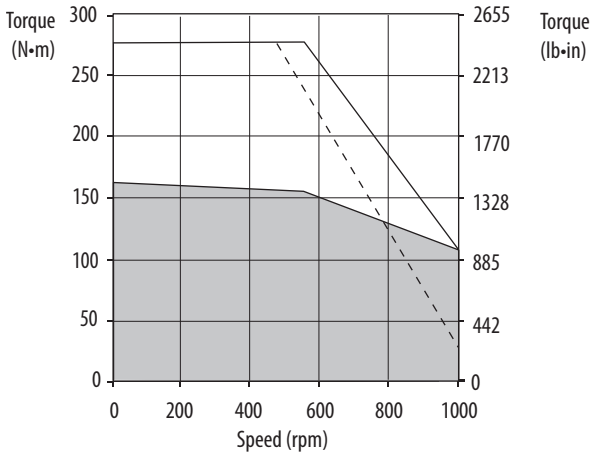

2198-S130-ERSx and MPL-B980C

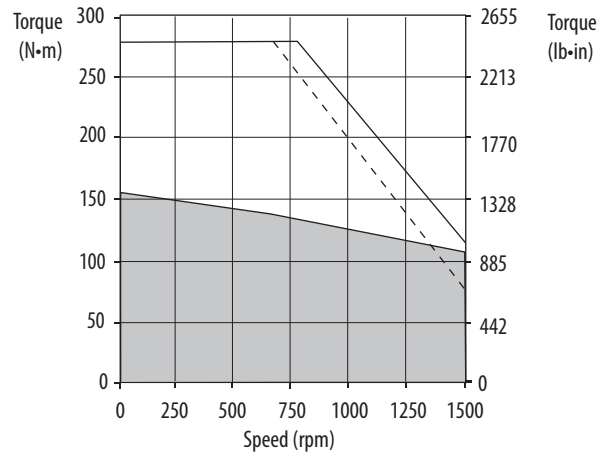

- = Intermittent operating region
- = Continuous operating region
- = Drive operation with 400V AC rms input voltage

Kinetix 5700 (400V-class) Drives/Kinetix MPL Servo Motor Curves (continued)

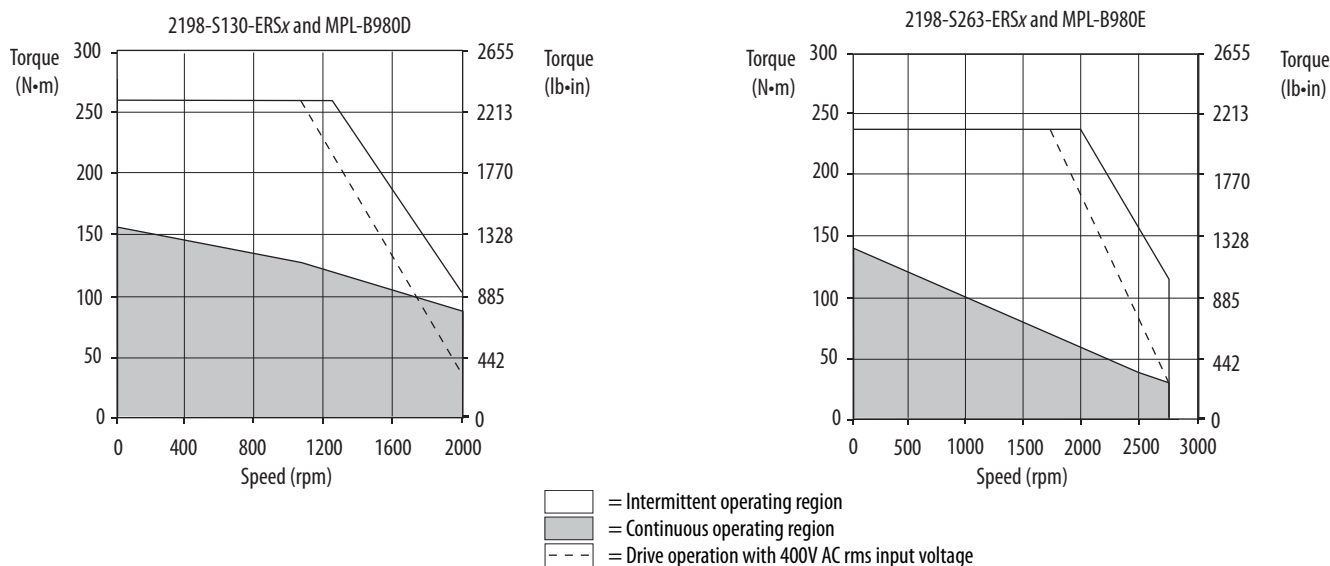

Kinetix 5700 (400V-class) Drives with Kinetix MPM Medium-inertia Motors

This section provides system combination information for the Kinetix 5700 drives (with 400 and 480V, nominal input) when matched with Kinetix MPM (400V-class) servo motors with absolute high-resolution encoders. Included are motor power/brake and feedback cable catalog numbers, system performance specifications, and the optimum torque/speed curves.

Kinetix MPM Motor Cable Combinations

Rotary Motor (400V-class) Cat. No.	Motor Power/Brake Cable	Motor Feedback Cable ⁽¹⁾
MPM-B1151x, MPM-B1152x, MPM-B1153E, MPM-B1153F	2090-CPxM7DF-16AAxx (standard, non-flex) 2090-CPxM7DF-16AFxx (continuous-flex)	2090-CFBM7DF-CEAAxx (standard, non-flex) ⁽²⁾ 2090-CFBM7DF-CEAFxx (continuous-flex) Absolute High-resolution Feedback
MPM-B1302F, MPM-B1302M, MPM-B1304C, MPM-B1304E		
MPM-B1651C, MPM-B1652C		
MPM-B1153T	2090-CPxM7DF-14AAxx (standard, non-flex) 2090-CPxM7DF-14AFxx (continuous-flex)	
MPM-B1302T, MPM-B1304M		
MPM-B1651F, MPM-B1653C		
MPM-B1651M, MPM-B1652E, MPM-B1652F, MPM-B1653E	2090-CPxM7DF-10AAxx (standard, non-flex) 2090-CPxM7DF-10AFxx (continuous-flex)	
MPM-B2152C, MPM-B2153B ⁽³⁾		
MPM-B1653F	2090-CPxM7DF-08AAxx (standard, non-flex) 2090-CPxM7DF-08AFxx (continuous-flex)	
MPM-B2152F, MPM-B2152M, MPM-B2153E, MPM-B2153F, ⁽³⁾		
MPM-B2154B, MPM-B2154E, MPM-B2154F ⁽³⁾		

(1) Use the 2198-K57CK-D15M feedback connector kit or 2198-H2DCK Hiperface-to-DSL converter kit with flying-lead cables on the drive end. Refer to Required Drive Accessories on [page 11](#).

(2) Applies to Kinetix 5700 drives and MPM-B1xxx-M/S through MPM-B2xxx-M/S motors with absolute high-resolution feedback.

(3) For applications that use these nine motors (catalog numbers MPM-B215x-xJ74AA with the brake option) where the power cable length exceeds 50 m (164 ft), 2090-CPBM7DF-06AAxx (6 AWG) cable is required. Motors without the brake option (catalog numbers MPM-B215x-xJ72AA can use the cable size as specified in the table regardless of cable length.

For cable configuration illustrations and feature descriptions, by catalog number, refer to 2090-Series Motor Power/Brake and Feedback Cables Overview beginning on [page 19](#).

Motor-end connector kits are available for motor power/brake and feedback cables. Refer to the Kinetix Motion Accessories Technical Data, publication [KNX-TD004](#), for connector kit catalog numbers and cable specifications. Cable length xx is in meters. For information on maximum cable lengths see Kinetix 5700 Servo Drives User Manual, publication [2198-UM002](#).

Kinetix MPM Motor Performance Specifications with Kinetix 5700 (400V-class) Drives

Rotary Motor Cat. No.	Base Speed rpm	Rated Speed rpm	Maximum Speed rpm	System Continuous Stall Current A 0-pk	System Continuous Stall Torque N·m (lb·in)	System Peak Stall Current A 0-pk	System Peak Stall Torque N·m (lb·in)	Motor Rated Output kW	Kinetix 5700 Drives (480V AC input)
MPM-B1151F	3000	4000	5000	2.71	2.3 (20.3)	8.8	6.0 (53.1)	0.75	2198-D006-ERSx
						9.9	6.6 (58.0)		2198-D012-ERSx
MPM-B1151T	6000	5000	7000	5.62	2.3 (20.3)	17.6	5.3 (46.9)	0.90	2198-D012-ERSx
						20.5	6.6 (58.0)		2198-D020-ERSx
MPM-B1152C	1500	2500	3000	3.61	5.0 (44.2)	12.4	13.5 (119)	1.20	2198-D012-ERSx
MPM-B1152F	3000	4000	5200	6.17	5.0 (44.2)	17.6	11.7 (103)	1.40	2198-D012-ERSx
						21.1	13.5 (119)		2198-D020-ERSx
MPM-B1152T	6000	4000	7000	11.02	5.0 (44.2)	28.2	10.7 (94.7)	1.40	2198-D020-ERSx
						37.9	13.5 (119)		2198-D032-ERSx
MPM-B1153E	2250	3000	3500	6.21	6.5 (57.5)	17.6	16.9 (149)	1.40	2198-D012-ERSx
						21.6	19.8 (175)		2198-D020-ERSx
MPM-B1153F	3000	4000	5500	9.20	6.5 (57.5)	28.2	17.9 (158)	1.40	2198-D020-ERSx
						32.0	19.8 (175)		2198-D032-ERSx
MPM-B1153T	6000	4000	7000	15.95	6.5 (57.5)	45.9	14.8 (131)	1.45	2198-D032-ERSx
						55.5	19.8 (175)		2198-D057-ERSx
MPM-B1302F	3000	4000	4500	8.57	6.6 (58.4)	22.1	13.5 (119)	1.65	2198-D020-ERSx
MPM-B1302M	4500	4000	6000	12.57	6.6 (58.4)	32.4	13.5 (119)	1.65	2198-D032-ERSx
MPM-B1302T	6000	4000	7000	16.83	6.7 (59.3)	43.4	13.5 (119)	1.65	2198-D032-ERSx
MPM-B1304C	1500	1870	2750	7.00	10.3 (91.1)	17.6	22.8 (202)	2.00	2198-D012-ERSx
						22.3	27.1 (240)		2198-D020-ERSx
MPM-B1304E	2250	3500	4000	10.75	10.2 (90.3)	28.2	23.4 (207)	2.20	2198-D020-ERSx
						34.2	27.1 (240)		2198-D032-ERSx
MPM-B1304M	4500	3500	6000	19.02	10.4 (92.0)	60.6	27.1 (240)	2.20	2198-D057-ERSx
MPM-B1651C	1500	3000	3500	10.21	11.4 (101)	28.2	22.7 (201)	2.50	2198-D020-ERSx
						29.2	23.2 (205)		2198-D032-ERSx
MPM-B1651F	3000	3000	5000	17.75	11.4 (101)	45.9	21.9 (194)	2.50	2198-D032-ERSx
						50.9	23.2 (205)		2198-D057-ERSx
MPM-B1651M	4500	3000	5000	22.46	11.4 (101)	56.8	23.2 (205)	2.50	2198-D057-ERSx
MPM-B1652C	1500	2500	2500	11.51	16.0 (142)	33.6	40.0 (354)	3.80	2198-D032-ERSx
MPM-B1652E	2250	3500	3500	20.94	21.1 (187)	60.5	48.0 (425)	4.30	2198-D057-ERSx
MPM-B1652F	3000	3500	4500	28.74	21.1 (187)	84.1	48.0 (425)	4.30	2198-D057-ERSx
MPM-B1653C	1500	2000	2500	20.05	26.7 (236)	59.2	67.8 (600)	4.60	2198-D057-ERSx
MPM-B1653E	2250	3000	3500	27.00	26.8 (237)	72.9	62.0 (549)	5.10	2198-D057-ERSx
MPM-B1653F	3000	3000	4000	34.94	31.0 (274)	94.3	56.1 (496)	5.10	2198-S086-ERSx
MPM-B2152C	1500	2000	2500	27.40	36.7 (325)	55.4	72.3 (640)	5.60	2198-D057-ERSx
MPM-B2152F	3000	2500	4500	43.54	34.1 (302)	98.0	72.2 (639)	5.90	2198-S086-ERSx
MPM-B2152M	4500	2500	5000	44.58	34.1 (302)	76.3	50.0 (442)	5.90	2198-S086-ERSx
MPM-B2153B	1250	1750	2000	24.06	48.0 (425)	60.0	101 (895)	6.80	2198-D057-ERSx
MPM-B2153E	2250	2000	3000	39.63	47.9 (424)	98.6	101 (895)	7.20	2198-S086-ERSx
MPM-B2153F	3000	2000	3800	43.86	45.6 (403)	98.4	98.9 (875)	7.20	2198-S086-ERSx

Kinetix MPM Motor Performance Specifications with Kinetix 5700 (400V-class) Drives (continued)

Rotary Motor Cat. No.	Base Speed rpm	Rated Speed rpm	Maximum Speed rpm	System Continuous Stall Current A 0-pk	System Continuous Stall Torque N·m (lb·in)	System Peak Stall Current A 0-pk	System Peak Stall Torque N·m (lb·in)	Motor Rated Output kW	Kinetix 5700 Drives (480V AC input)
MPM-B2154B	1250	1750	2000	35.46	62.7 (555)	98.0	154 (1363)	6.90	2198-S086-ERSx
MPM-B2154E	2250	2000	3000	43.68	55.9 (495)	98.3	112 (991)	7.50	2198-S086-ERSx
MPM-B2154F	3000	2000	3300	44.40	56.2 (497)	83.6	87.9 (778)	7.50	2198-S086-ERSx

Performance specification data and curves reflect nominal system performance of a typical system with the motor ambient at 40 °C (104 °F), drive ambient at 50 °C (122 °F), and rated line voltage. For additional information on ambient and line conditions, refer to Motion Analyzer software.

Kinetix 5700 (400V-class) Drives/Kinetix MPM Servo Motor Curves

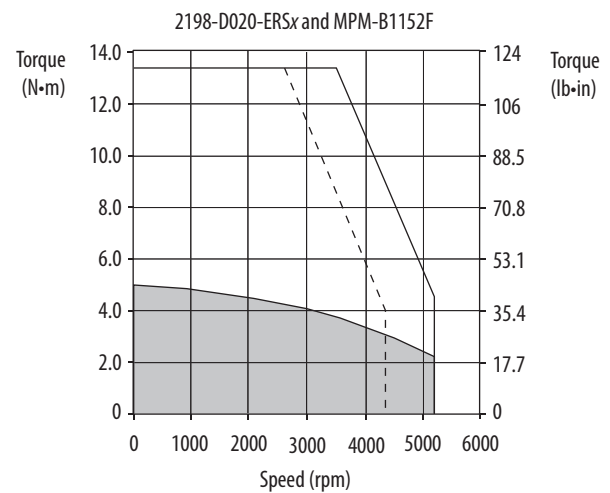
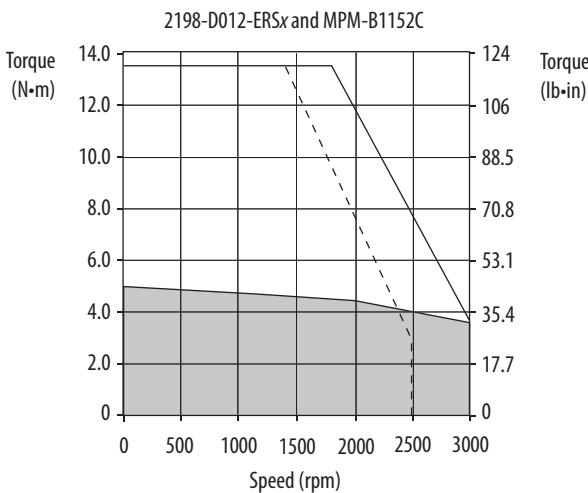
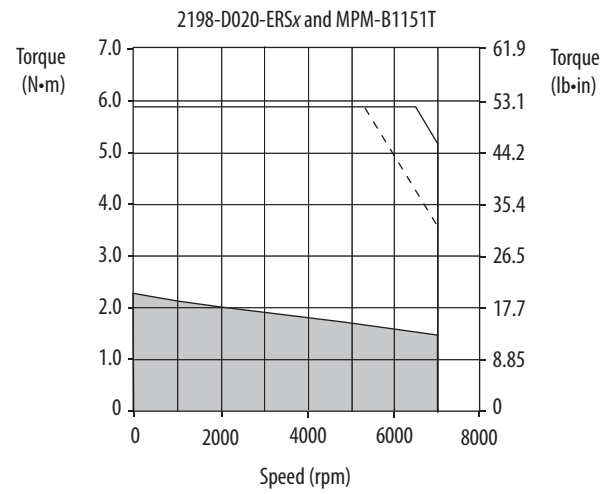
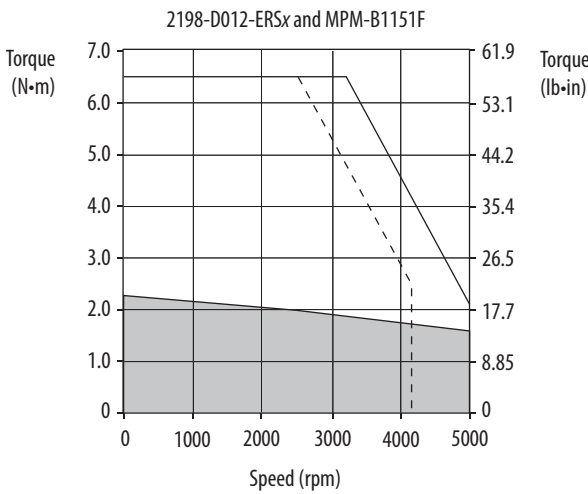

- = Intermittent operating region
- = Continuous operating region
- = Drive operation with 400V AC rms input voltage

Kinetix 5700 (400V-class) Drives/Kinetix MPM Servo Motor Curves (continued)

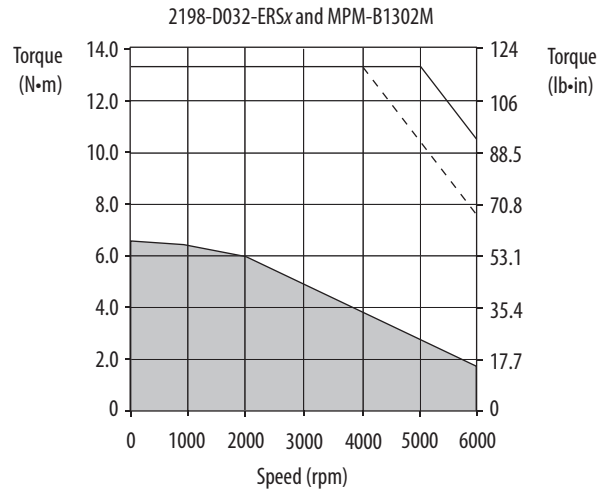
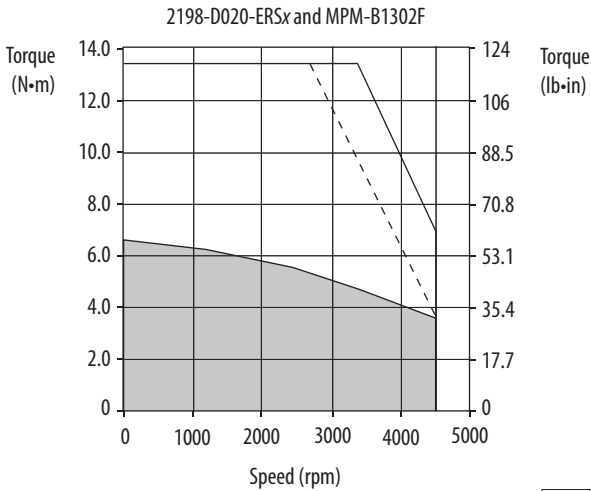
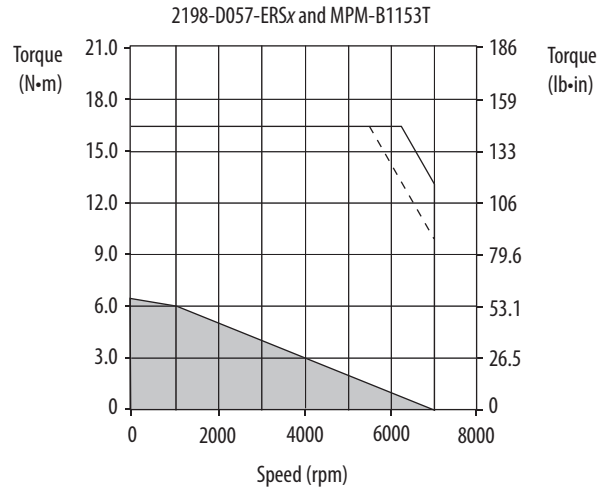
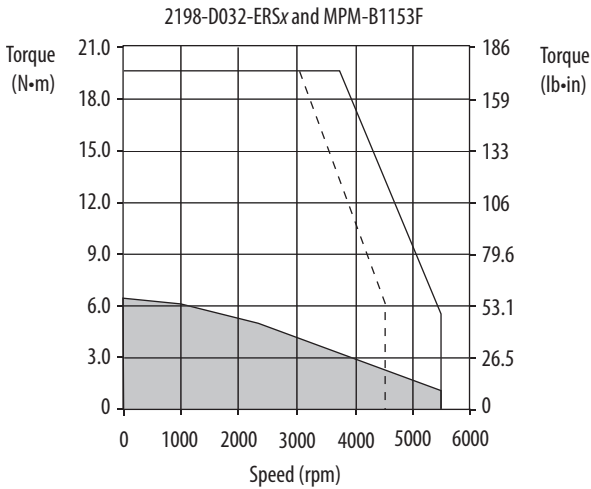
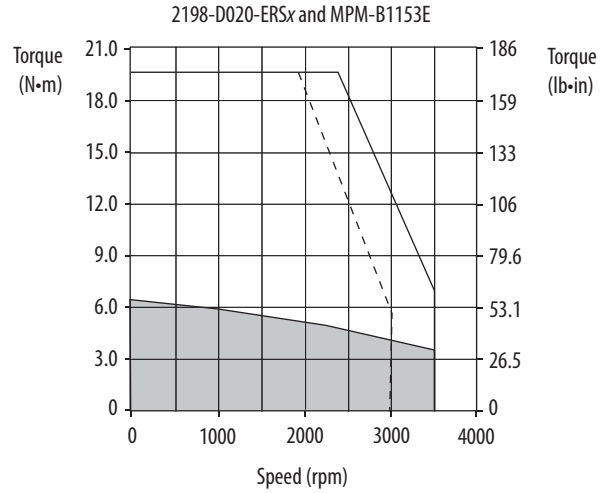
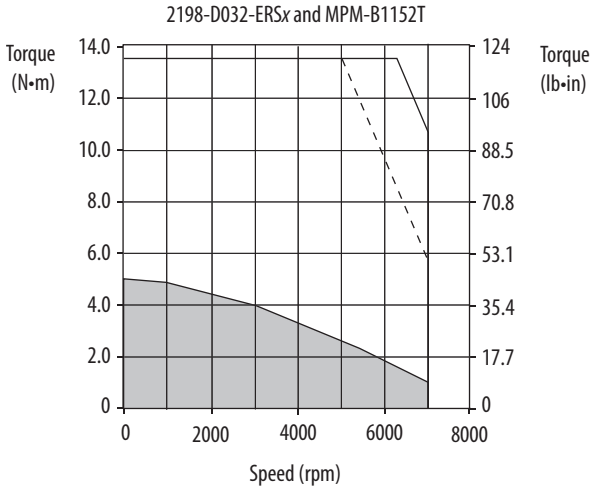

- = Intermittent operating region
- = Continuous operating region
- = Drive operation with 400V AC rms input voltage

Kinetix 5700 (400V-class) Drives/Kinetix MPM Servo Motor Curves (continued)

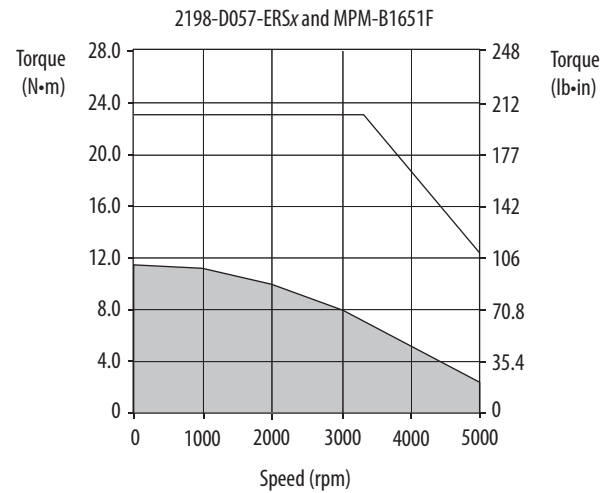
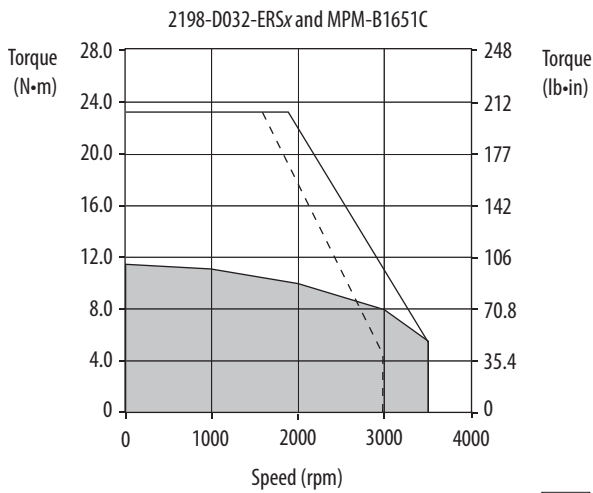
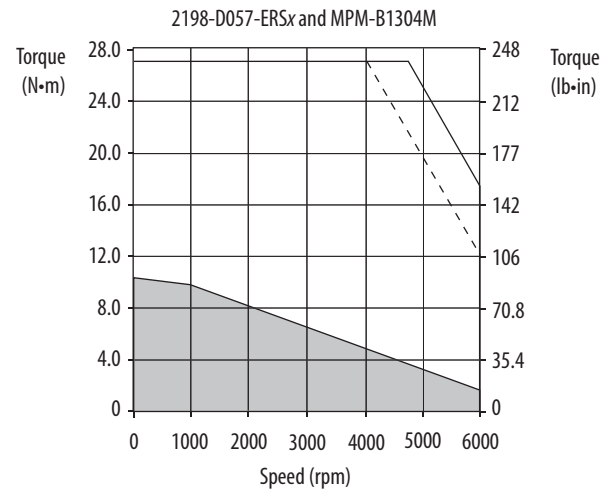
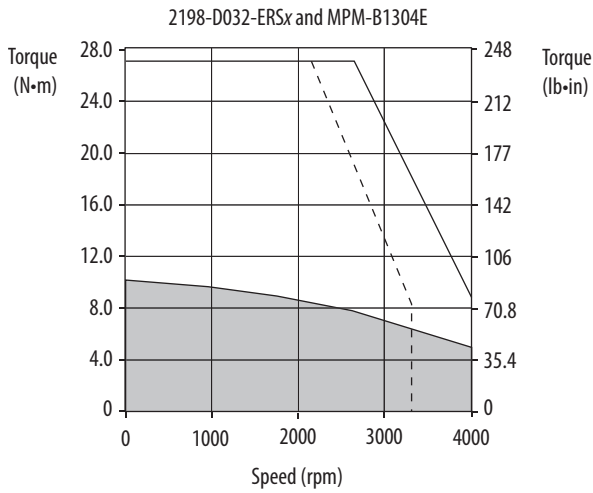
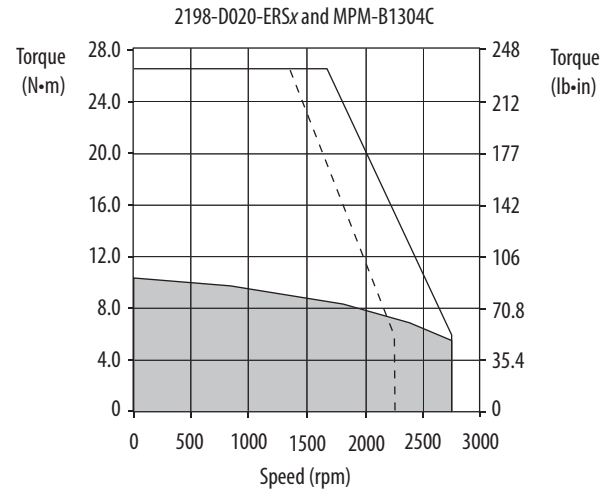
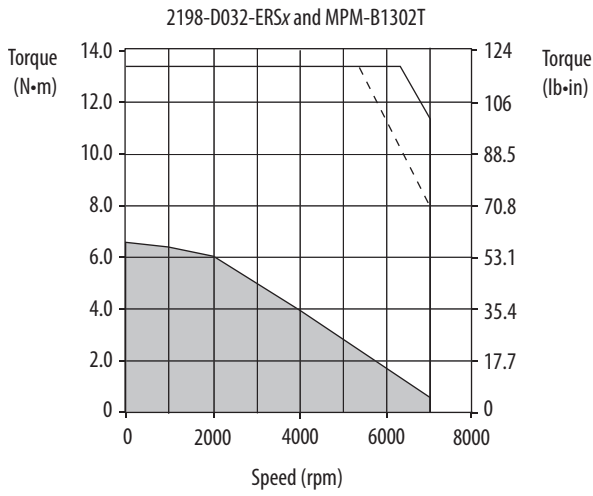

- = Intermittent operating region
- = Continuous operating region
- = Drive operation with 400V AC rms input voltage

Kinetix 5700 (400V-class) Drives/Kinetix MPM Servo Motor Curves (continued)

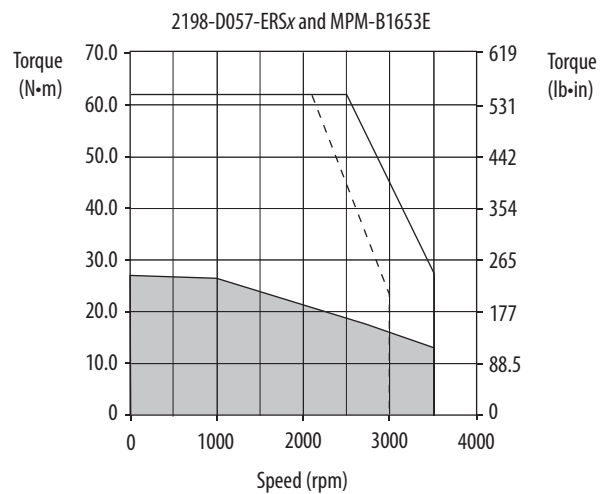
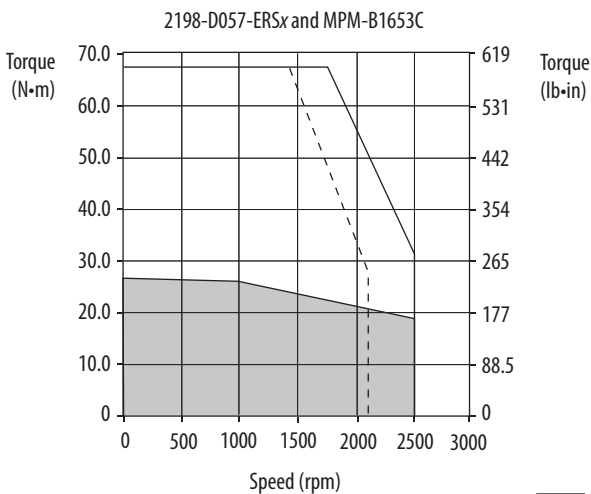
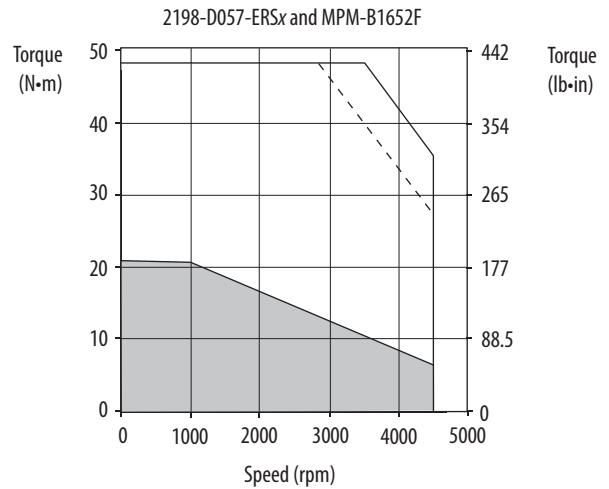
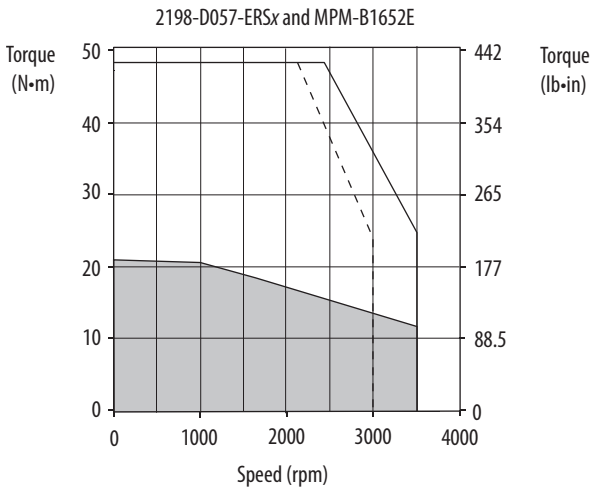
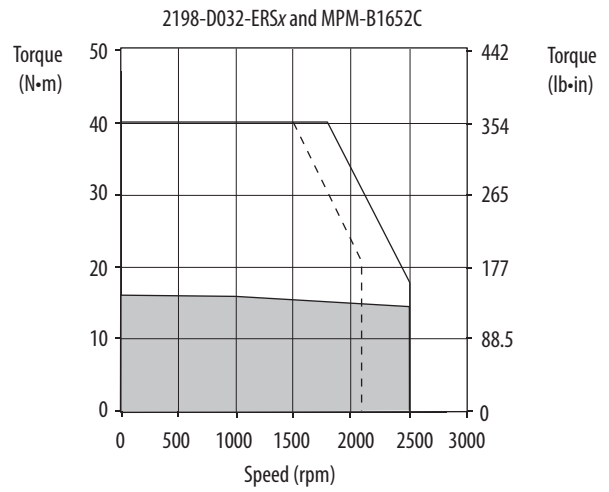
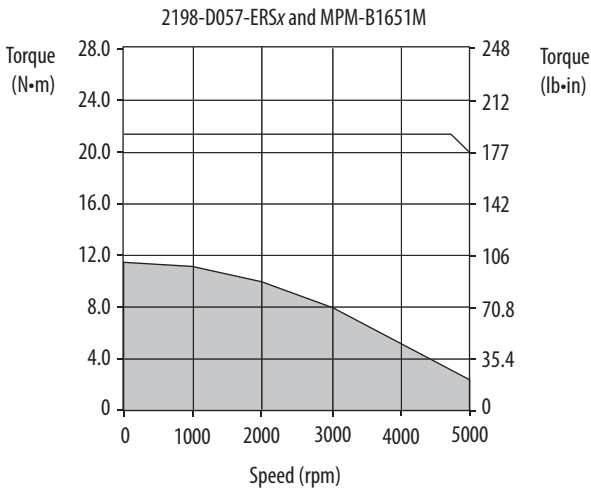

- = Intermittent operating region
- = Continuous operating region
- = Drive operation with 400V AC rms input voltage

Kinetix 5700 (400V-class) Drives/Kinetix MPM Servo Motor Curves (continued)

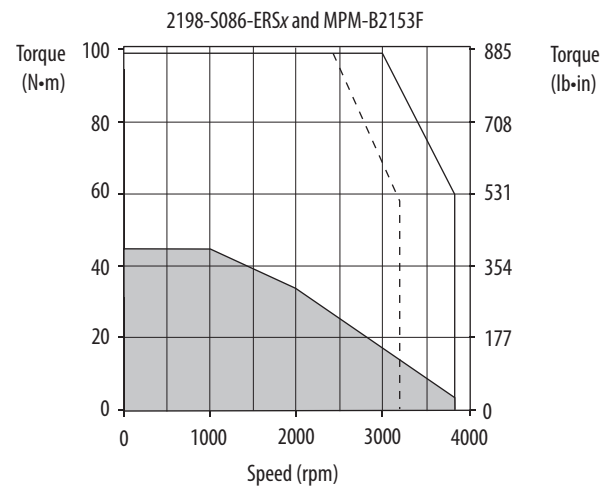
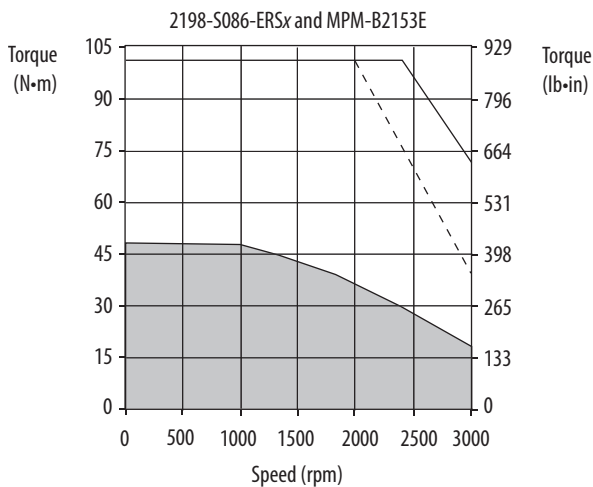
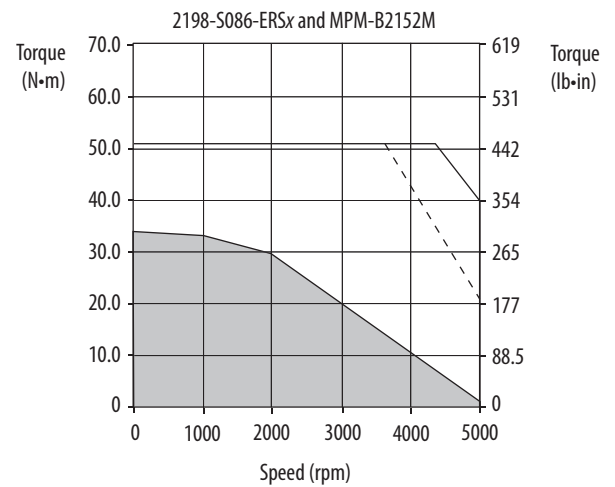
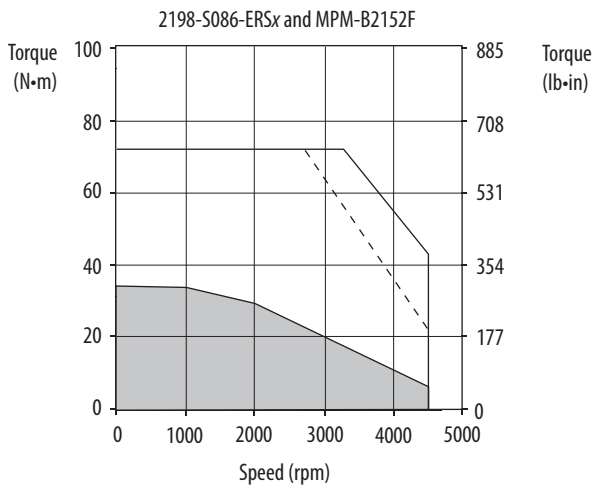
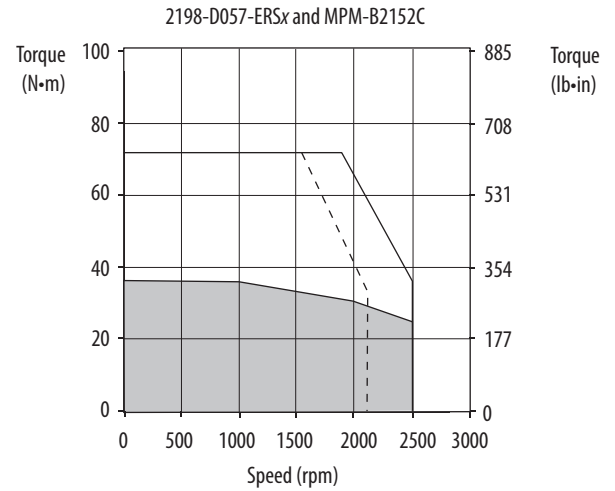
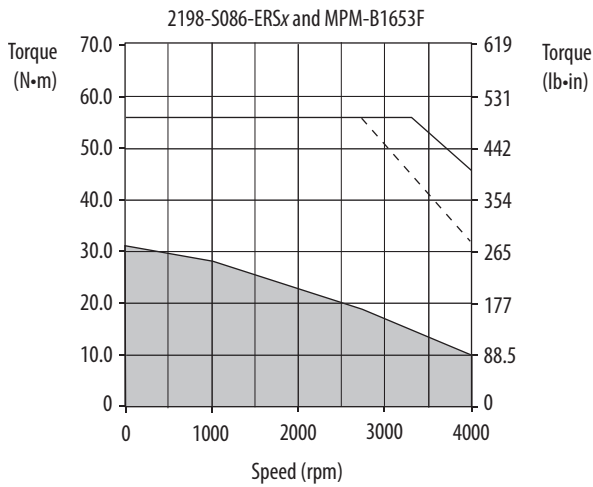

- = Intermittent operating region
- = Continuous operating region
- = Drive operation with 400V AC rms input voltage

Kinetix 5700 (400V-class) Drives/Kinetix MPM Servo Motor Curves (continued)

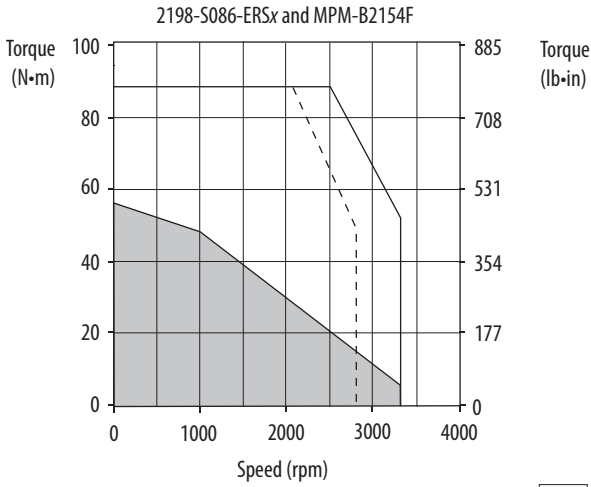
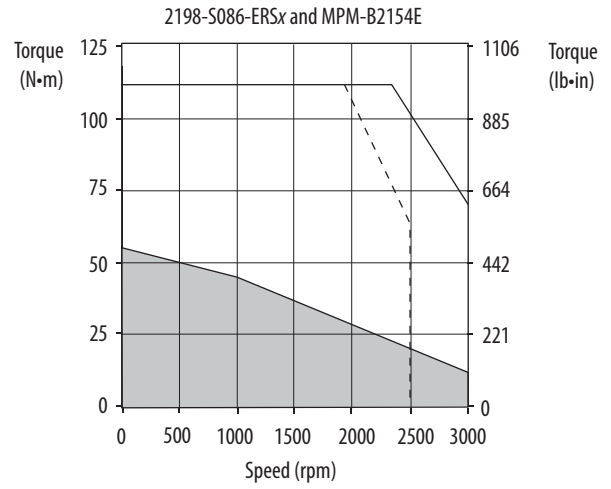
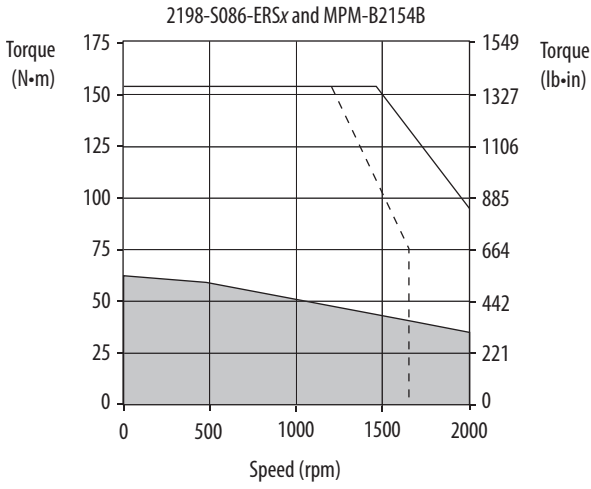

- = Intermittent operating region
- = Continuous operating region
- = Drive operation with 400V AC rms input voltage

Kinetix 5700 (400V-class) Drives with Kinetix MPF Food-grade Motors

This section provides system combination information for the Kinetix 5700 drives (with 400 and 480V, nominal input) when matched with Kinetix MPF (400V-class) servo motors. Included are motor power/brake and feedback cable catalog numbers, system performance specifications, and the optimum torque/speed curves.

Kinetix MPF Motor Cable Combinations

Rotary Motor (400V-class) Cat. No.	Motor Power/Brake Cable	Motor Feedback Cable ⁽¹⁾
MPF-B310P, MPF-B320P, MPF-B330P	2090-CPxM7DF-16AAxx (standard, non-flex) 2090-CPxM7DF-16AFxx (continuous-flex)	2090-CFBM7DF-CEAAxx (standard, non-flex) 2090-CFBM7DF-CEAFxx (continuous-flex) Absolute High-resolution Feedback
MPF-B430P		
MPF-B4530K, MPF-B4540F		
MPF-B540K	2090-CPxM7DF-10AAxx (standard, non-flex) 2090-CPxM7DF-10AFxx (continuous-flex)	

(1) Use the 2198-K57CK-D15M feedback connector kit or 2198-H2DCK Hiperface-to-DSL converter kit with flying-lead cables on the drive end. Refer to Required Drive Accessories on [page 11](#).

For cable configuration illustrations and feature descriptions, by catalog number, refer to 2090-Series Motor Power/Brake and Feedback Cables Overview beginning on [page 19](#).

Motor-end connector kits are available for motor power/brake and feedback cables. Refer to the Kinetix Motion Accessories Technical Data, publication [KNX-TD004](#), for connector kit catalog numbers and cable specifications. Cable length xx is in meters. For information on maximum cable lengths see Kinetix 5700 Servo Drives User Manual, publication [2198-UM002](#).

Kinetix MPF Motor Performance Specifications with Kinetix 5700 (400V-class) Drives

Rotary Motor Cat. No.	Rated Speed rpm	Maximum Speed rpm	System Continuous Stall Current A 0-pk	System Continuous Stall Torque N·m (lb·in)	System Peak Stall Current A 0-pk	System Peak Stall Torque N·m (lb·in)	Motor Rated Output kW	Kinetix 5700 Drives (480V AC operation)
MPF-B310P	5000	5000	2.30	1.60 (14)	7.10	3.6 (32)	0.77	2198-D006-ERSx
MPF-B320P	5000	5000	4.24	3.10 (27)	14.0	7.8 (69)	1.5	2198-D012-ERSx
MPF-B330P	5000	5000	5.70	4.18 (37)	17.6	10.4 (92.0)	1.6	2198-D012-ERSx
					19.0	11.1 (98)		2198-D020-ERSx
MPF-B430P	5000	5000	9.20	6.55 (58)	28.2	17.6 (156)	2.0	2198-D020-ERSx
					32.0	19.8 (175)		2198-D032-ERSx
MPF-B4530K	4000	4000	9.90	8.25 (73)	28.2	18.7 (165)	2.4	2198-D020-ERSx
					31.0	20.3 (179)		2198-D032-ERSx
MPF-B4540F	3000	3000	9.10	10.20 (90)	28.2	26.2 (232)	2.5	2198-D020-ERSx
					29.0	27.1 (240)		2198-D032-ERSx
MPF-B540K	4000	4000	20.5	19.4 (171)	60.0	48.6 (430)	4.1	2198-D057-ERSx

Performance specification data and curves reflect nominal system performance of a typical system with the motor ambient at 40 °C (104 °F), drive ambient at 50 °C (122 °F), and rated line voltage. For additional information on ambient and line conditions, refer to Motion Analyzer software.

Kinetix 5700 (400V-class) Drives/Kinetix MPF Servo Motor Curves

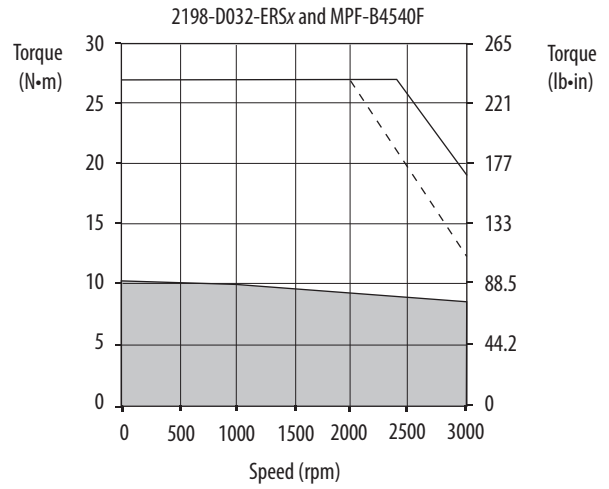
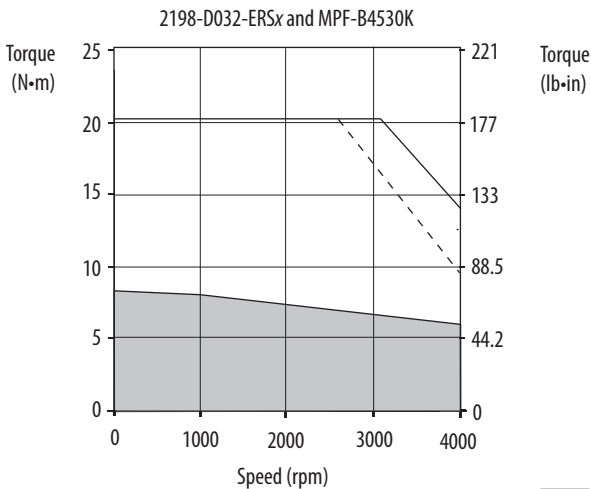
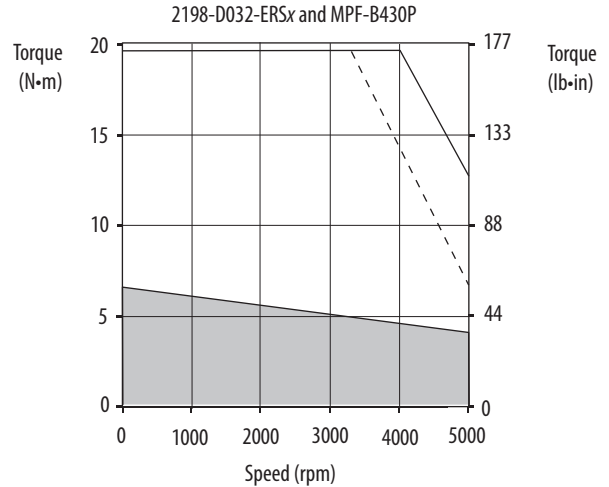
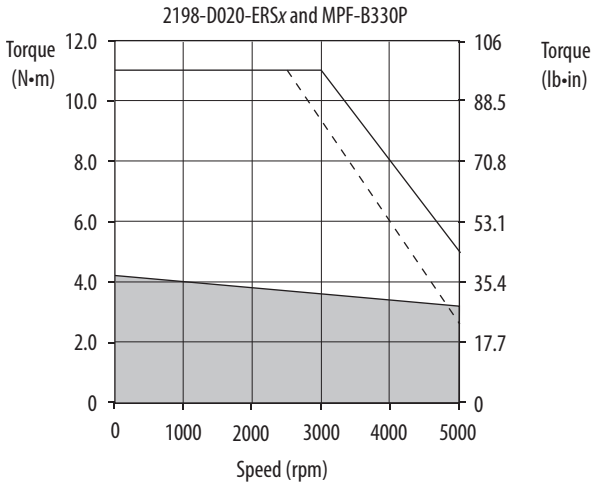
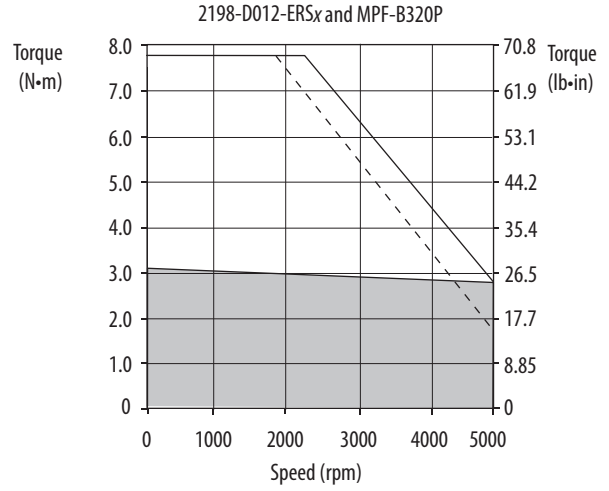
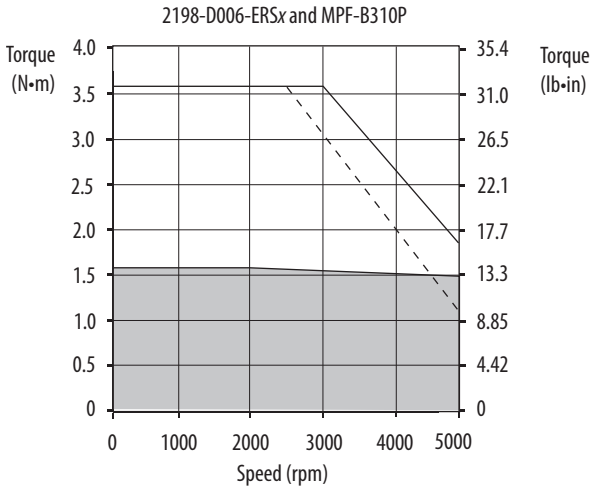

- = Intermittent operating region
- = Continuous operating region
- = Drive operation with 400V AC rms input voltage

Kinetix 5700 (400V-class) Drives/Kinetix MPF Servo Motor Curves (continued)

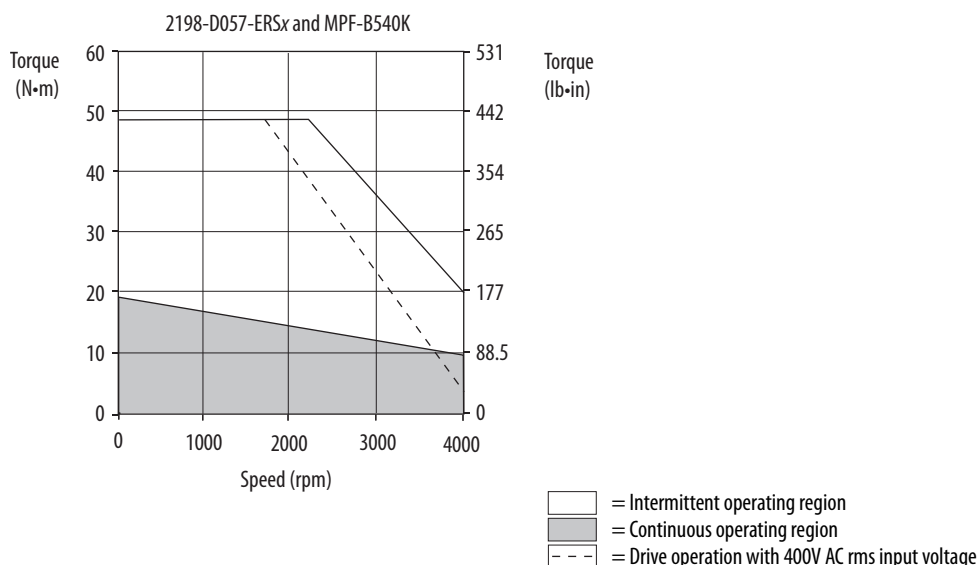

Kinetix 5700 (400V-class) Drives with Kinetix MPS Stainless-steel Motors

This section provides system combination information for the Kinetix 5700 drives (with 400 and 480V, nominal input) when matched with Kinetix MPS (400V-class) servo motors. Included are motor power/brake and feedback cable catalog numbers, system performance specifications, and the optimum torque/speed curves.

Kinetix MPS Motor Cable Combinations

Rotary Motor (400V-class) Cat. No.	Motor Power/Brake Cable	Motor Feedback Cable ⁽¹⁾
MPS-B330P	2090-CPxM7DF-16AAxx (standard, non-flex) 2090-CPxM7DF-16AFxx (continuous-flex)	2090-CFBM7DF-CEAAxx (standard, non-flex) 2090-CFBM7DF-CEAFxx (continuous-flex)
MPS-B4540F		Absolute High-resolution Feedback
MPS-B560F	2090-CPxM7DF-14AAxx (standard, non-flex) 2090-CPxM7DF-14AFxx (continuous-flex)	

(1) Use the 2198-K57CK-D15M feedback connector kit or 2198-H2DCK Hiperface-to-DSL converter kit with flying-lead cables on the drive end. Refer to Required Drive Accessories on [page 11](#).

For cable configuration illustrations and feature descriptions, by catalog number, refer to 2090-Series Motor Power/Brake and Feedback Cables Overview beginning on [page 19](#). Motor-end connector kits are available for motor power/brake and feedback cables. Refer to the Kinetix Motion Accessories Technical Data, publication [KNX-TD004](#), for connector kit catalog numbers and cable specifications. Cable length xx is in meters. For information on maximum cable lengths see Kinetix 5700 Servo Drives User Manual, publication [2198-UM002](#).

Kinetix MPS Motor Performance Specifications with Kinetix 5700 (400V-class) Drives

Rotary Motor Cat. No.	Rated Speed rpm	Maximum Speed rpm	System Continuous Stall Current A 0-pk	System Continuous Stall Torque N·m (lb·in)	System Peak Stall Current A 0-pk	System Peak Stall Torque N·m (lb·in)	Motor Rated Output kW	Kinetix 5700 Drives (480V AC input)
MPS-B330P	5000	5000	4.9	3.60 (32)	17.6	10.5 (92.9)	1.3	2198-D012-ERSx
					19.0	11.0 (97.2)		2198-D020-ERSx
MPS-B4540F	3000	3000	7.1	8.1 (72)	17.6	19.2 (170)	1.4	2198-D012-ERSx
					26.0	27.1 (240)		2198-D020-ERSx
MPS-B560F	3000	3000	17.0	21.5 (190)	45.9	49.7 (440)	3.5	2198-D032-ERSx
					68.0	67.8 (600)		2198-D057-ERSx

Performance specification data and curves reflect nominal system performance of a typical system with the motor ambient at 40 °C (104 °F), drive ambient at 50 °C (122 °F), and rated line voltage. For additional information on ambient and line conditions, refer to Motion Analyzer software.

Kinetix 5700 (400V-class) Drives/Kinetix MPS Servo Motor Curves

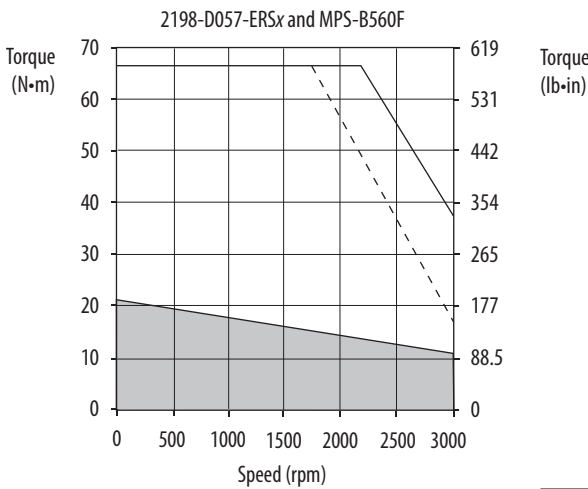
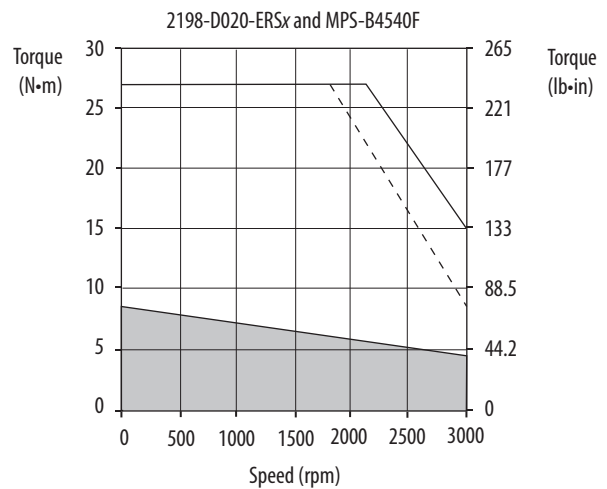
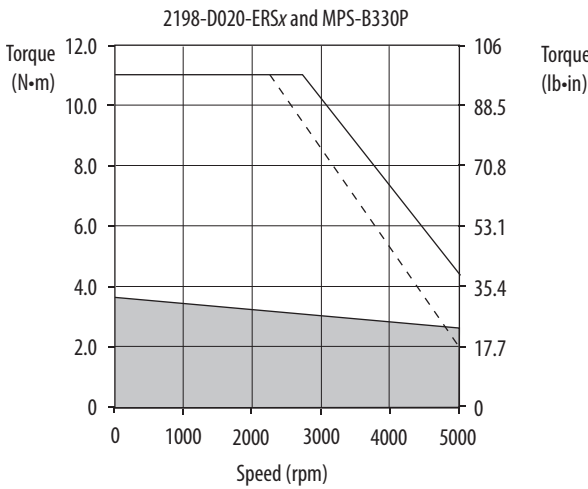

- = Intermittent operating region
- = Continuous operating region
- = Drive operation with 400V AC rms input voltage

Kinetix 5700 (400V-class) Drives with Kinetix HPK Asynchronous Servo Motors

This section provides system combination information for the Kinetix 5700 drives (with 480V, nominal input) when matched with HPK-Series motors. These motors are available with 460V and 400V windings. Included are motor feedback cable catalog numbers, system performance specifications, and the optimum torque/speed curves.

Kinetix HPK Motor Cable Combinations (460V motors)

Rotary Motor Cat. No.	Motor Power/Brake Cable	Motor Feedback Cable ⁽¹⁾
HPK-B1307C, HPK-B1308C, HPK-B1310C, HPK-B1613C	Customer Supplied	2090-CFBM7DF-CEAAxx (standard, non-flex) 2090-CFBM7DF-CEAFxx (continuous-flex) Absolute High-resolution Feedback
HPK-B1307E, HPK-B1308E, HPK-B1609E		
HPK-B1611E, HPK-B1815C, HPK-B1613E, HPK-B2010C		

(1) Use the 2198-K57CK-D15M feedback connector kit or 2198-H2DCK Hiperface-to-DSL converter kit with flying-lead cables on the drive end. Refer to Required Drive Accessories on [page 11](#).

For cable configuration illustrations and feature descriptions, by catalog number, refer to 2090-Series Motor Power/Brake and Feedback Cables Overview beginning on [page 19](#).

Motor-end connector kits are available for motor power/brake and feedback cables. Refer to the Kinetix Motion Accessories Technical Data, publication [KNX-TD004](#), for connector kit catalog numbers and cable specifications. Cable length xx is in meters. For information on maximum cable lengths see Kinetix 5700 Servo Drives User Manual, publication [2198-UM002](#).

Kinetix HPK (460V) Motor Performance Specifications with Kinetix 5700 (400V-class) Drives

Rotary Motor Cat. No.	Base Speed rpm	Maximum Speed rpm	System Continuous Stall Current A 0-pk	System Continuous Stall Torque N·m (lb·in)	System Peak Stall Current A 0-pk	System Peak Stall Torque N·m (lb·in)	Motor Rated Output kW (Hp)	Kinetix 5700 (480V AC input)
HPK-B1307C	1500	3000	48.2	112 (991)	113.0	260 (2301)	17.1 (22.9)	2198-S086-ERSx
HPK-B1308C			59.6	141 (1248)	119.3	262 (2319)	21.6 (28.9)	2198-S086-ERSx
HPK-B1310C			64.9	155 (1372)	144.0	325 (2876)	23.8 (31.9)	2198-S130-ERSx
HPK-B1613C			109.8	271 (2398)	217.0	542 (4797)	41.7 (55.9)	2198-S160-ERSx
HPK-B1307E	3000	5000	81.0	96.0 (849)	146.6	165 (1460)	29.8 (39.9)	2198-S130-ERSx
HPK-B1308E			91.4	115 (1018)	190.3	230 (2036)	35.7 (47.8)	2198-S160-ERSx
HPK-B1609E			120.2	150 (1327)	217.0	270 (2390)	46.5 (62.3)	2198-S160-ERSx
HPK-B1611E	3000	5000	149.0	183 (1619)	338.4	400 (3540)	57.0 (76.4)	2198-S263-ERSx
HPK-B1815C	1500	3000	153.7	360 (3186)	402.0	850 (7523)	55.9 (74.9)	2198-S312-ERSx
HPK-B1613E	3000	5000	191.0	237 (2097)	440.0	520 (4602)	73.7 (98.8)	2198-S312-ERSx
HPK-B2010C	1500	3000	196.4	482 (4266)	440.0	970 (8585)	75.0 (100.5)	2198-S312-ERSx

Performance specification data and curves reflect nominal system performance of a typical system with the motor ambient at 40 °C (104 °F), drive ambient at 50 °C (122 °F), and rated line voltage. For additional information on ambient and line conditions, refer to Motion Analyzer software.

Kinetix 5700 (400V-class) Drives/Kinetix HPK (460V) Motor Curves

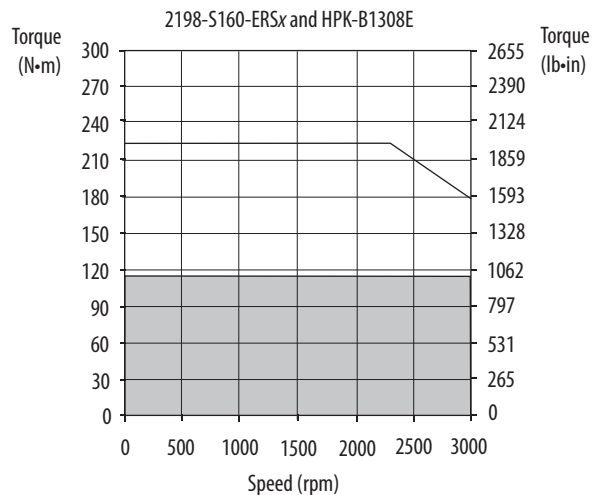
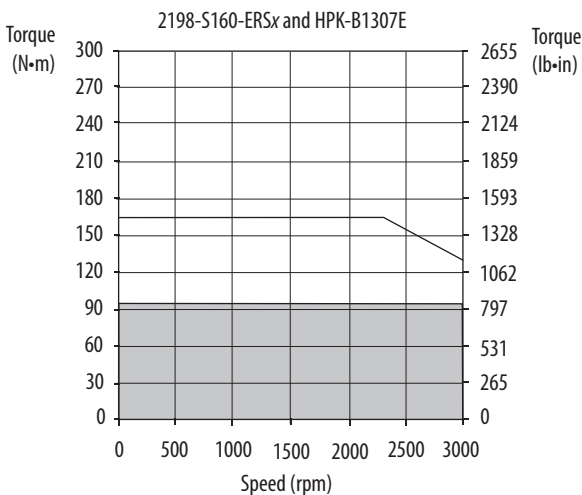
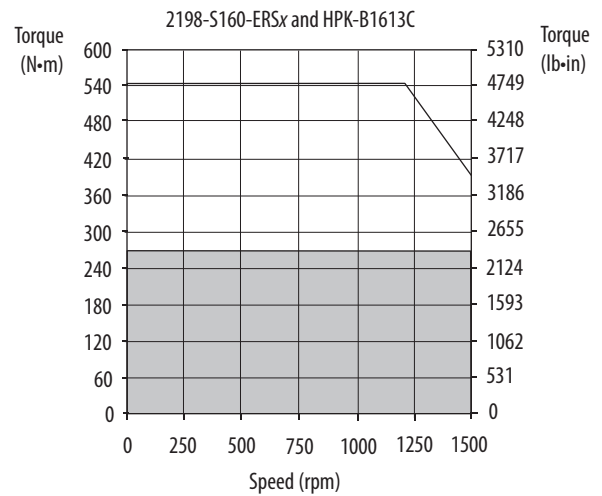
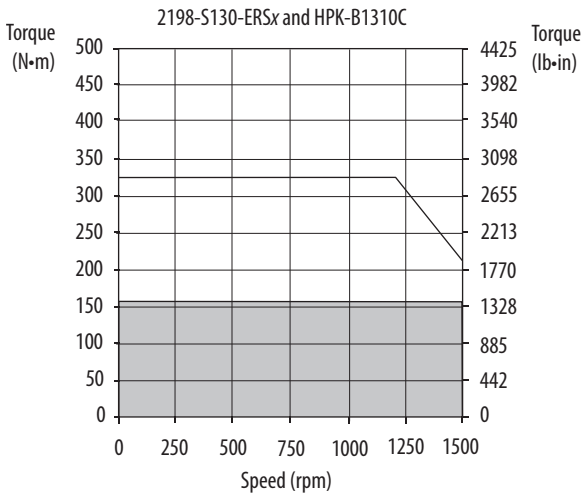
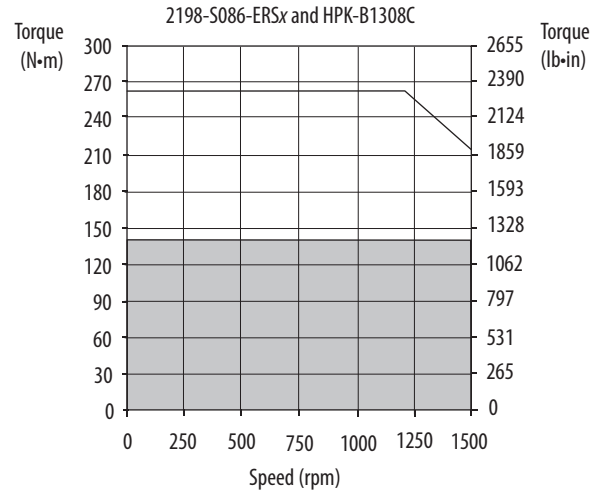
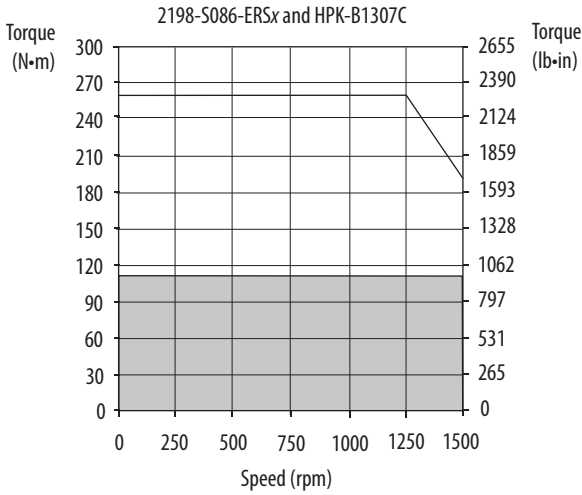

= Intermittent operating region
 = Continuous operating region

Kinetix 5700 (400V-class) Drives/Kinetix HPK (460V) Motor Curves (continued)

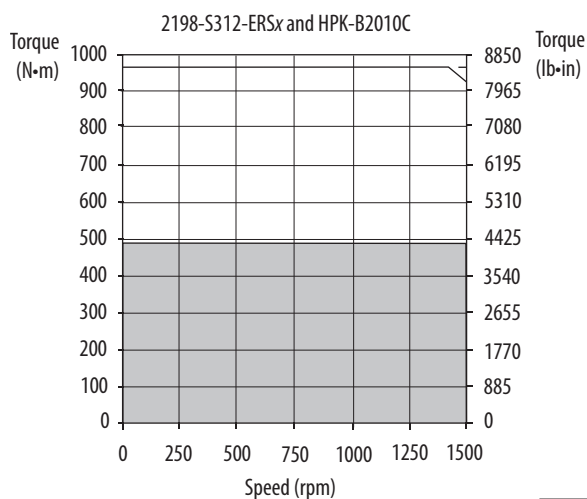
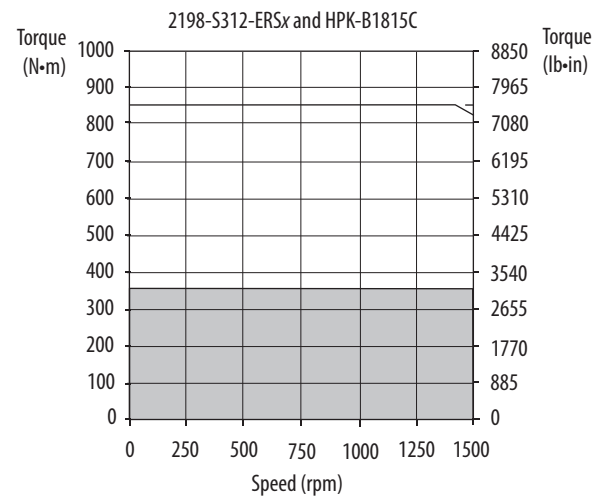
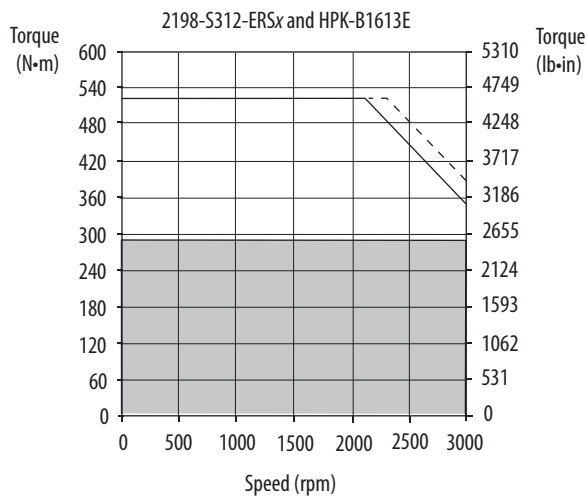
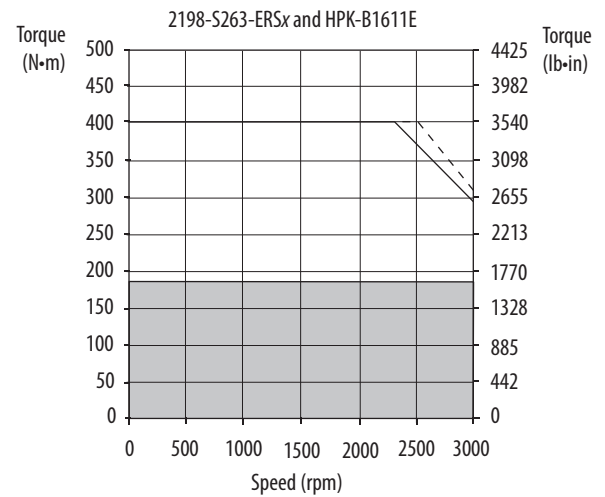
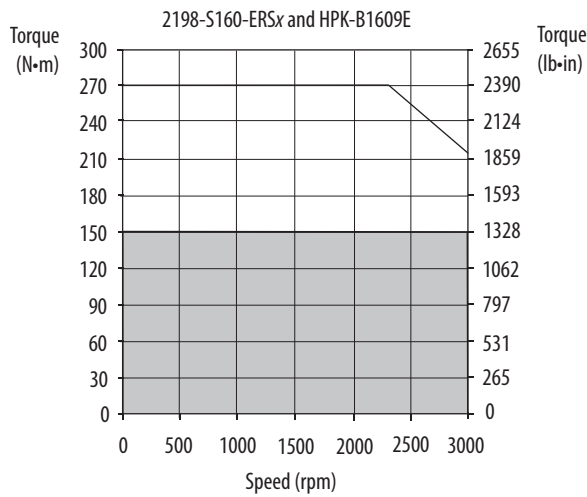

- = Intermittent operating region
- = Continuous operating region
- = Drive operation with 750V DC (rms) input voltage

Kinetix HPK Motor Cable Combinations (400V motors)

Rotary Motor Cat. No.	Motor Power/Brake Cable	Motor Feedback Cable ⁽¹⁾
HPK-E1307C, HPK-E1310C	Customer Supplied	2090-CFBM7DF-CEAAxx (standard, non-flex)
HPK-E1307E, HPK-E1308E		2090-CFBM7DF-CEAFxx (continuous-flex) Absolute High-resolution Feedback

(1) Use the 2198-K57CK-D15M feedback connector kit or 2198-H2DCK Hiperface-to-DSL converter kit with flying-lead cables on the drive end. Refer to Required Drive Accessories on [page 11](#). For cable configuration illustrations and feature descriptions, by catalog number, refer to 2090-Series Motor Power/Brake and Feedback Cables Overview beginning on [page 19](#). Motor-end connector kits are available for motor power/brake and feedback cables. Refer to the Kinetix Motion Accessories Technical Data, publication [KNX-TD004](#), for more information. Cable length xx is in meters. Refer to the Kinetix Motion Accessories Technical Data, publication [KNX-TD004](#), for standard cable lengths.

Kinetix HPK (400V) Motor Performance Specifications with Kinetix 5700 (400V-class) Drives

Rotary Motor Cat. No.	Base Speed rpm	Maximum Speed rpm	System Continuous Stall Current A 0-pk	System Continuous Stall Torque N·m (lb·in)	System Peak Stall Current A 0-pk	System Peak Stall Torque N·m (lb·in)	Motor Rated Output kW (Hp)	Kinetix 5700 (480V AC input)
HPK-E1307C	1500	3000	58.5	112 (991)	146.6	263 (2327)	17.1 (22.9)	2198-S130-ERSx
HPK-E1310C			80.0	155 (1372)	200.0	380 (3363)	23.8 (32.4)	2198-S160-ERSx
HPK-E1307E	3000	5000	102.0	96.0 (849)	217.0	202 (1788)	29.8 (39.9)	2198-S160-ERSx
HPK-E1308E			112.8	107 (947)	217.7	200 (1770)	33.2 (45.0)	2198-S160-ERSx

Performance specification data and curves reflect nominal system performance of a typical system with the motor ambient at 40 °C (104 °F), drive ambient at 50 °C (122 °F), and rated line voltage. For additional information on ambient and line conditions, refer to Motion Analyzer software.

Kinetix 5700 (400V-class) Drives/Kinetix HPK (400V) Motor Curves

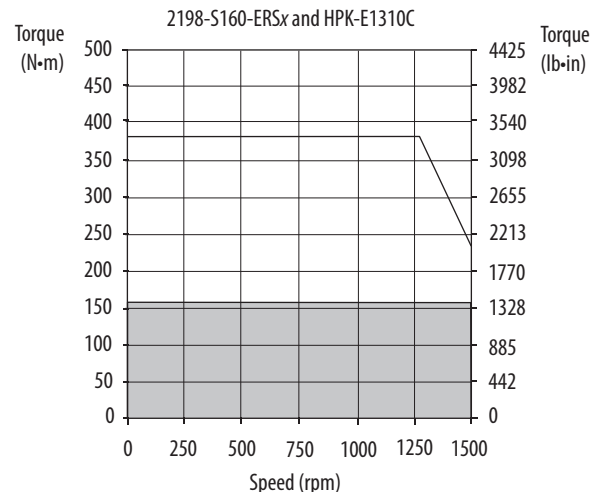
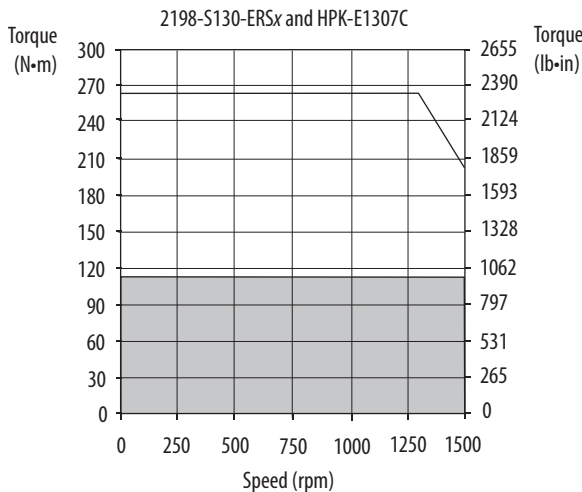

= Intermittent operating region
 = Continuous operating region

Kinetix 5700 (400V-class) Drives/Kinetix HPK (400V) Motor Curves (continued)

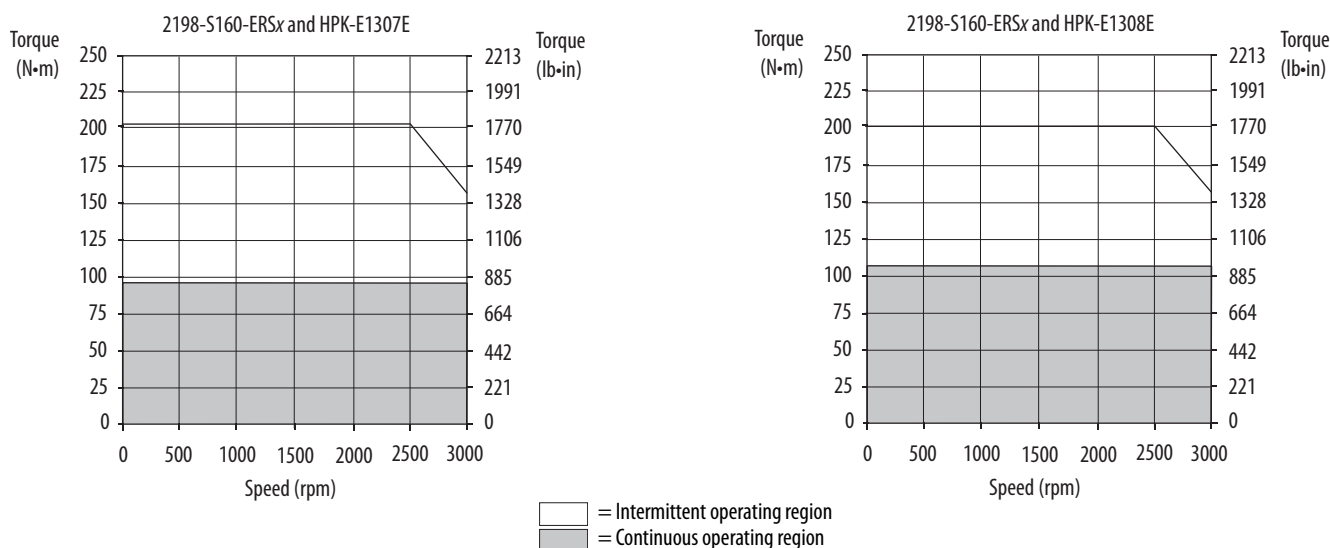

Kinetix 5700 (400V-class) Drives with Kinetix RDB Direct-drive Motors

This section provides system combination information for the Kinetix 5700 drives (with 400 and 480V, nominal input) when matched with Kinetix RDB direct-drive motors. Included are motor power and feedback cable catalog numbers, system performance specifications, and the optimum torque/speed curves.

Kinetix RDB Motor Cable Combinations

Rotary Motor (400V-class) Cat. No.	Motor Power Cable	Motor Feedback Cable ⁽¹⁾
RDB-B21519, RDB-B21529	2090-CPWM7DF-16AAxx (standard, non-flex)	2090-XXNFMF-Sxx (standard, non-flex) 2090-CFBM7DF-CDAFxx (continuous-flex) Absolute High-resolution Feedback
RDB-B29014, RDB-B29016, RDB-B29024	2090-CPWM7DF-16AFxx (continuous-flex)	
RDB-B2151C, RDB-B21539	2090-CPWM7DF-14AAxx (standard, non-flex)	
RDB-B29019, RDB-B29034	2090-CPWM7DF-14AFxx (continuous-flex)	
RDB-B2152C	2090-CPWM7DF-12AAxx (standard, non-flex)	
RDB-B29026		
RDB-B2153C	2090-CPWM7DF-10AAxx (standard, non-flex) 2090-CPWM7DF-10AFxx (continuous-flex)	
RDB-B29036, RDB-B41014		
RDB-B29029, RDB-B41016, RDB-B41024	2090-CPWM7DF-08AAxx (standard, non-flex) 2090-CPWM7DF-08AFxx (continuous-flex)	
RDB-B29039, RDB-B41018, RDB-B41026, RDB-B41035	2090-CPBM7DF-06AAxx (standard, non-flex)	

(1) Use the 2198-K57CK-D15M feedback connector kit with flying-lead cables on the drive end. Refer to Required Drive Accessories on [page 11](#).

For cable configuration illustrations and feature descriptions, by catalog number, refer to 2090-Series Motor Power/Brake and Feedback Cables Overview beginning on [page 19](#).

Motor-end connector kits are available for motor power/brake and feedback cables. Refer to the Kinetix Motion Accessories Technical Data, publication [KNX-TD004](#), for connector kit catalog numbers and cable specifications. Cable length xx is in meters. For information on maximum cable lengths see Kinetix 5700 Servo Drives User Manual, publication [2198-UM002](#).

Kinetix RDB Motor Performance Specifications with Kinetix 5700 (400V-class) Drives

Rotary Motor Cat. No.	Base Speed rpm	Maximum Speed rpm	System Continuous Stall Current A 0-pk	System Continuous Stall Torque N·m (lb·in)	System Peak Stall Current A 0-pk	System Peak Stall Torque N·m (lb·in)	Motor Rated Output kW	Kinetix 5700 Drives (480V AC input)
RDB-B21519	750	1235	9.9	32.7 (289)	27.3	86.5 (766)	3.64	2198-D020-ERSx
RDB-B2151C	1500	2125	17.3	32.7 (289)	46.4	86.5 (766)	5.23	2198-D032-ERSx
RDB-B21529	750	1035	12.2	45.4 (402)	32.8	116 (1027)	4.33	2198-D032-ERSx
RDB-B2152C	1500	2125	23.5	45.4 (402)	63.2	116 (1027)	6.41	2198-D057-ERSx
RDB-B21539	750	1250	15.8	53.7 (475)	45.9	137 (1213)	5.34	2198-D032-ERSx
					47.9	143(1266)		2198-D057-ERSx
RDB-B2153C	1500	2250	29.4	53.7 (475)	82.6	143(1266)	5.87	2198-D057-ERSx
RDB-B29014	200	450	5.9	49.2 (435)	17.6	110 (973)	1.97	2198-D012-ERSx
RDB-B29016	375	785	10.0	49.2 (435)	28.2	100 (885)	3.18	2198-D020-ERSx
					31.0	110 (973)		2198-D032-ERSx
RDB-B29019	750	1500	19.1	49.2 (435)	58.7	110 (973)	3.63	2198-D057-ERSx
RDB-B29024	200	435	10.7	98.0 (867)	28.2	183 (1620)	3.33	2198-D020-ERSx
					33.0	214 (1894)		2198-D032-ERSx
RDB-B29026	375	885	21.9	98.0 (867)	67.2	214 (1894)	4.05	2198-D057-ERSx
RDB-B29029	750	1200	36.2	98.0 (867)	111	214 (1894)	4.05	2198-S086-ERSx
RDB-B29034	200	500	17.4	140 (1239)	56.6	318 (2815)	5.16	2198-D057-ERSx
RDB-B29036	375	750	26.0	140 (1239)	32.5	122 (1080)	5.49	2198-D057-ERSx
					84.9	318 (2814)		2198-S086-ERSx
RDB-B29039	750	1000	50.9	122 (1080)	121.6	204 (1806)	4.41	2198-S086-ERSx
					183.8	308 (2726)		2198-S130-ERSx
RDB-B41014	200	385	17.8	183 (1619)	45.9	305 (2699)	5.20	2198-D032-ERSx
					51.2	340 (3009)		2198-D057-ERSx
RDB-B41016	375	700	33.2	183 (1619)	95.5	340 (3009)	4.83	2198-S086-ERSx
RDB-B41018	625	700	48.8	183 (1619)	121.6	295 (2611)	4.83	2198-S086-ERSx
					140	340 (3009)		2198-S130-ERSx
RDB-B41024	200	365	31.5	332 (2938)	95.5	690 (6107)	7.29	2198-S086-ERSx
RDB-B41026	375	600	50.9	308 (2726)	121.6	478 (4231)	7.29	2198-S086-ERSx
					175	690 (6107)		2198-S130-ERSx
RDB-B41035	250	490	50.9	426 (3770)	121.6	669 (5921)	8.69	2198-S086-ERSx
					183.8	1010 (8939)		2198-S130-ERSx

Performance specification data and curves reflect nominal system performance of a typical system with the motor ambient at 40 °C (104 °F), drive ambient at 50 °C (122 °F), and rated line voltage. For additional information on ambient and line conditions, refer to Motion Analyzer software.

Kinetix 5700 (400V-class) Drives with Kinetix RDB Motor Curves

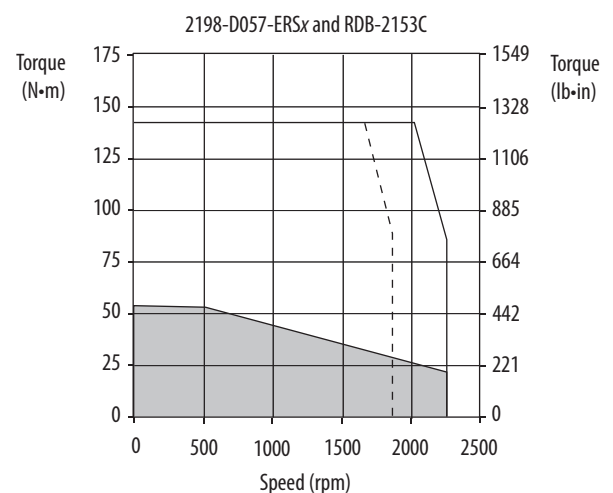
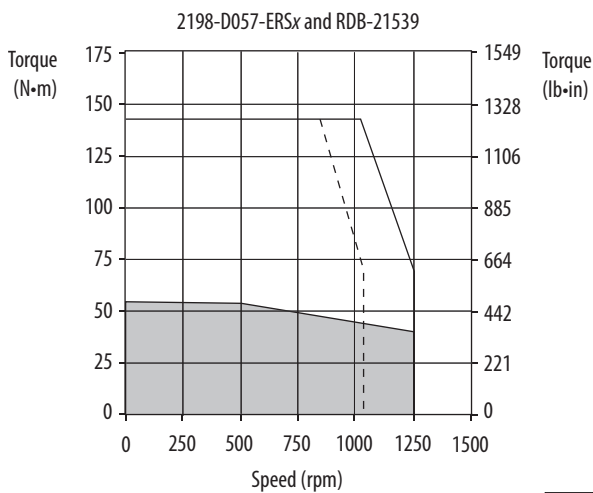
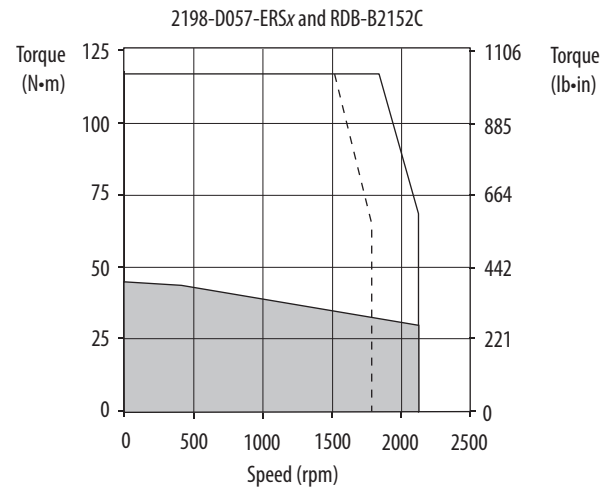
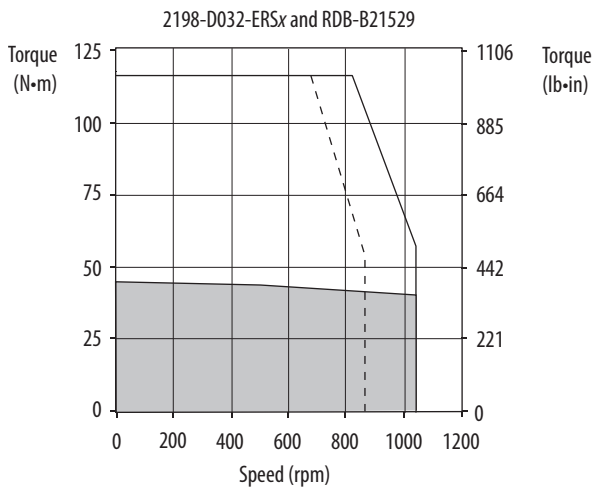
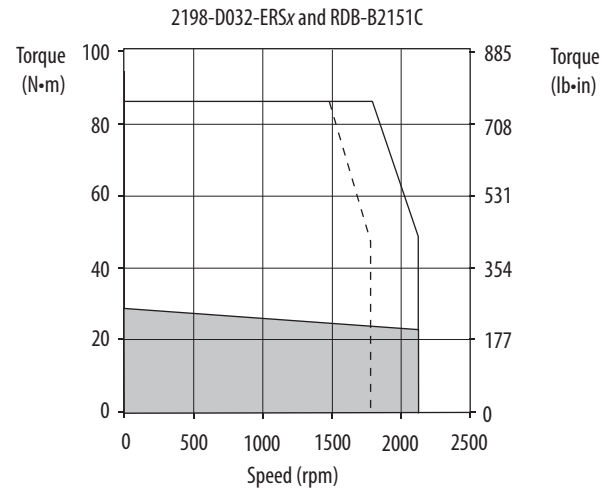
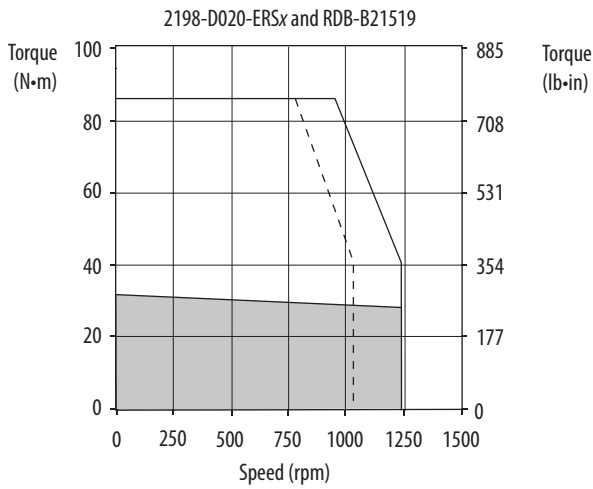

- = Intermittent operating region
- = Continuous operating region
- = Drive operation with 400V AC rms input voltage

Kinetix 5700 (400V-class) Drives with Kinetix RDB Motor Curves (continued)

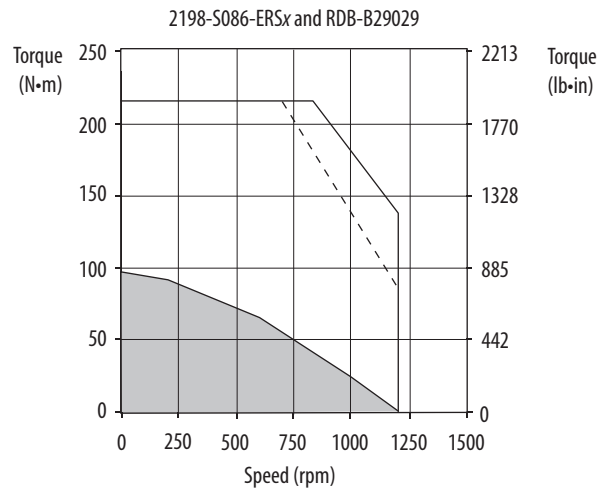
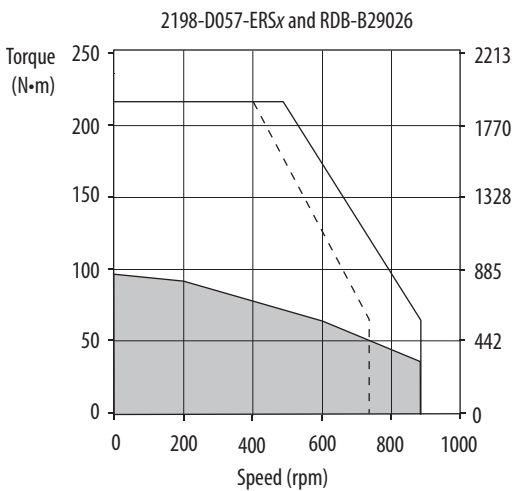
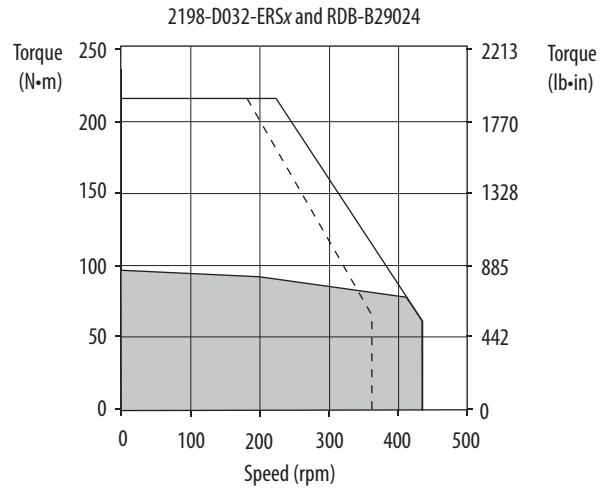
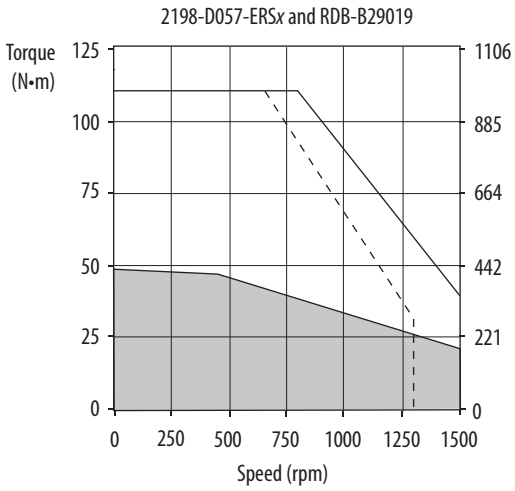
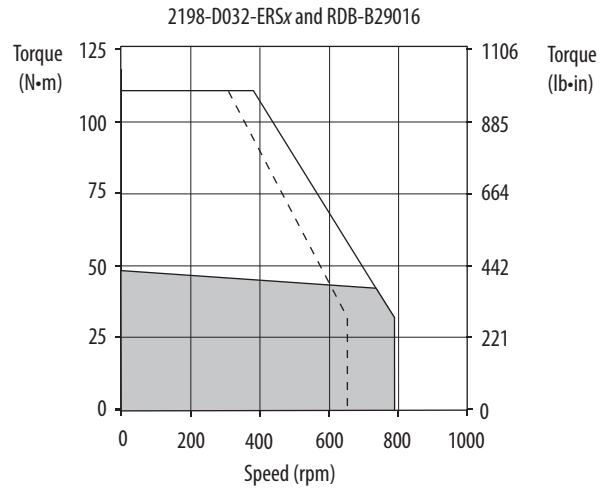
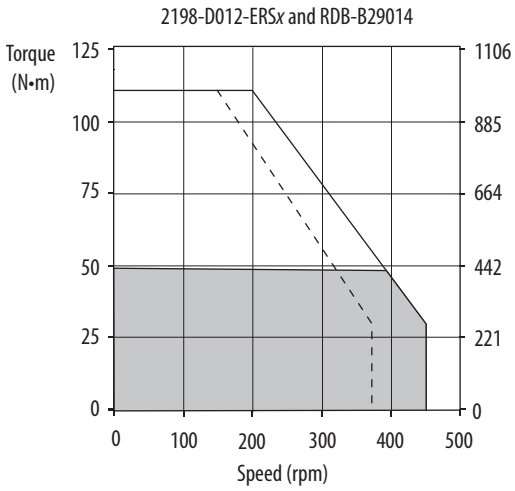

- = Intermittent operating region
- = Continuous operating region
- = Drive operation with 400V AC rms input voltage

Kinetix 5700 (400V-class) Drives with Kinetix RDB Motor Curves (continued)

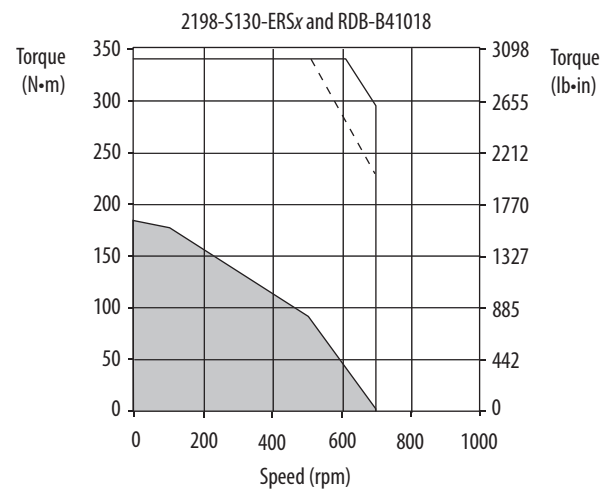
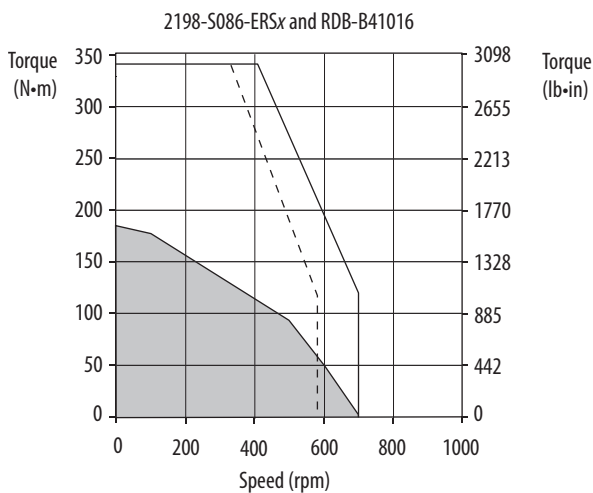
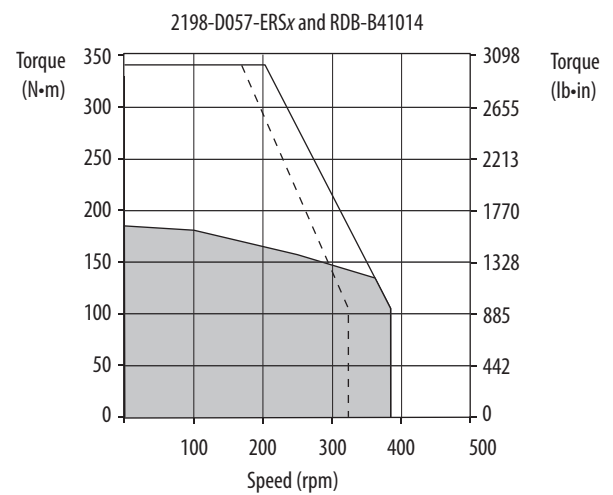
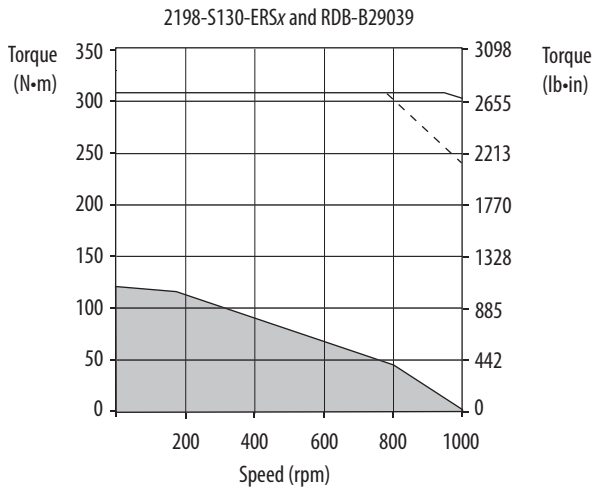
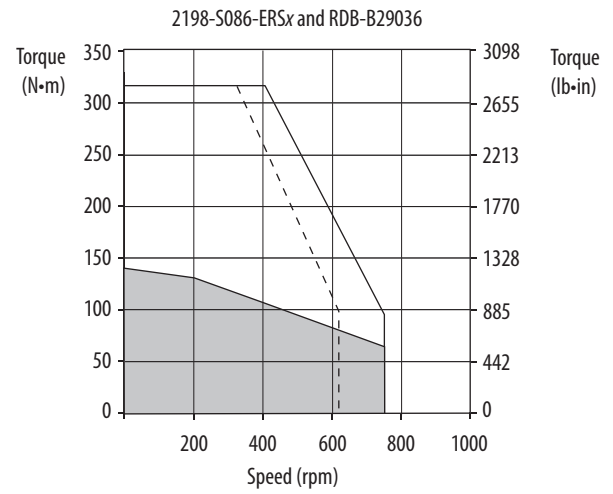
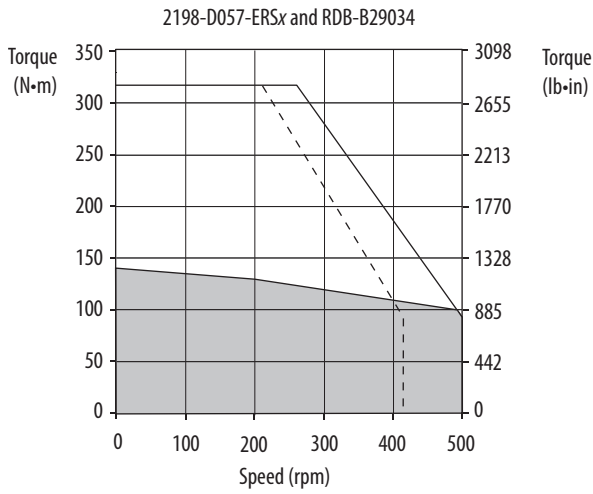

- = Intermittent operating region
- = Continuous operating region
- = Drive operation with 400V AC rms input voltage

Kinetix 5700 (400V-class) Drives with Kinetix RDB Motor Curves (continued)

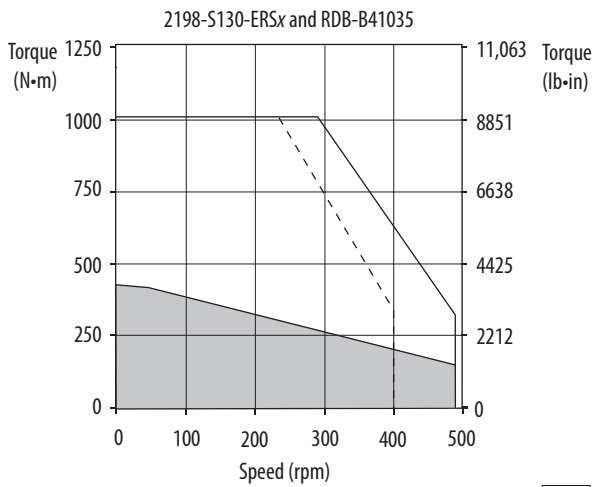
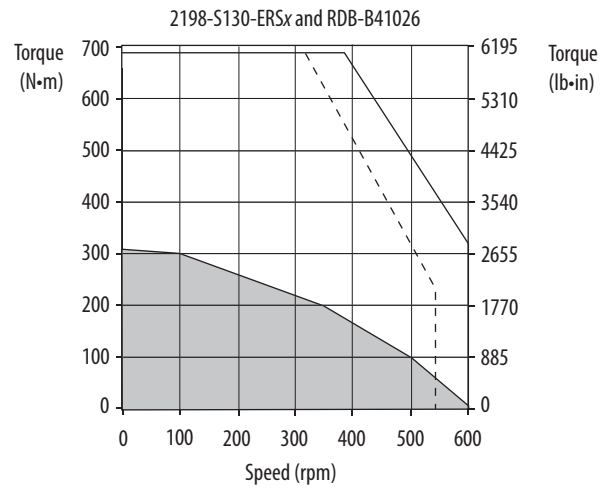
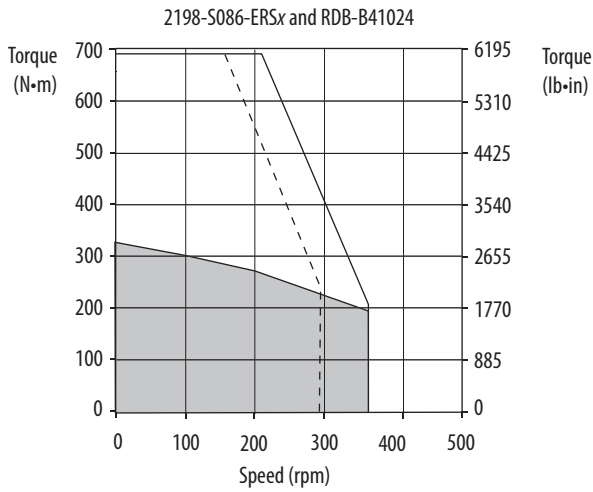

- = Intermittent operating region
- = Continuous operating region
- = Drive operation with 400V AC rms input voltage

Kinetix 5700 Servo Drives with LDAT-Series Integrated Linear Thrusters

This section provides system combination information for the Kinetix 5700 drives (with 400 and 480V, nominal input) when matched with LDAT-Series integrated linear thrusters. Included are motor power/brake and feedback cable catalog numbers, system performance specifications, and the optimum force/velocity curves.

LDAT-Series Cable Combinations

Linear Thruster Cat. No.	Motor Power Cable	Motor Feedback Cable ⁽¹⁾
LDAT-S031xxx-xxx, LDAT-S032xxx-xxx, LDAT-S033xxx-xxx	2090-CPWM7DF-16AAxx (standard, non-flex) 2090-CPWM7DF-16AFxx (continuous-flex)	2090-CFBM7DF-CEAAxx (standard, non-flex) ⁽²⁾ 2090-CFBM7DF-CEAFxx (continuous-flex) Absolute High-resolution Feedback
LDAT-S051xxx-xxx, LDAT-S052xxx-xxx, LDAT-S053xxx-xxx, LDAT-S054xxx-xxx		
LDAT-S072xxx-xxx, LDAT-S073xxx-xxx, LDAT-S074xxx-xxx, LDAT-S076xxx-Exx		
LDAT-S102xxx-xxx, LDAT-S103xxx-xxx, LDAT-S104xxx-xxx, LDAT-S106xxx-Exx		
LDAT-S152xxx-xxx, LDAT-S153xxx-xxx, LDAT-S154xxx-xxx, LDAT-S156xxx-Exx		
LDAT-S076xxx-Dxx	2090-CPWM7DF-14AAxx (standard, non-flex) 2090-CPWM7DF-14AFxx (continuous-flex)	2090-XXNFMF-Sxx (standard, non-flex) ⁽³⁾ 2090-CFBM7DF-CDAFxx (continuous-flex) Incremental Feedback
LDAT-S106xxx-Dxx		
LDAT-S156xxx-Dxx		

(1) Use the 2198-K57CK-D15M feedback connector kit or 2198-H2DCK (series B or later) Hiperface-to-DSL converter kit with flying-lead cables on the drive end. Refer to Required Drive Accessories on [page 11](#).

(2) Applies to Kinetix 5700 drives and LDAT-Sxxxxxx-xDx linear thrusters with absolute high-resolution feedback.

(3) Applies to Kinetix 5700 drives and LDAT-Sxxxxxx-xBx linear thrusters with incremental feedback.

For cable configuration illustrations and feature descriptions, by catalog number, refer to 2090-Series Motor Power/Brake and Feedback Cables Overview beginning on [page 19](#).

Motor-end connector kits are available for motor power/brake and feedback cables. Refer to the Kinetix Motion Accessories Technical Data, publication [KNX-TD004](#), for connector kit catalog numbers and cable specifications. Cable length xx is in meters. For information on maximum cable lengths see Kinetix 5700 Servo Drives User Manual, publication [2198-UM002](#).

LDAT-Series Performance Specifications with Kinetix 5700 (400V-class) Drives

Performance Specifications with Frame 30 Linear Thrusters

Linear Thruster Cat. No.	Velocity, max 460V AC m/s	System Continuous Stall Current Amps 0-pk	System Continuous Stall Force N (lb)	System Peak Stall Current Amps 0-pk	System Peak Stall Force N (lb)	Rated Output 460V AC kW	Kinetix 5700 Drives (480V AC input)
LDAT-S031010-Dxx	2.4	4.8	81 (18)	12.2	168 (38)	0.20	2198-D012-ERSx
LDAT-S031020-Dxx	3.1					0.25	
LDAT-S031030-Dxx	3.5					0.29	
LDAT-S031040-Dxx	3.8					0.31	
LDAT-S032010-Dxx	3.1	7.4	126 (28)	24.3	336 (76)	0.40	2198-D020-ERSx
LDAT-S032020-Dxx	4.1					0.52	
LDAT-S032030-Dxx	4.7					0.59	
LDAT-S032040-Dxx	5.0					0.63	
LDAT-S032010-Exx	3.1	3.7	126 (28)	12.2	336 (76)	0.40	2198-D012-ERSx
LDAT-S032020-Exx	4.1					0.52	
LDAT-S032030-Exx	4.7					0.59	
LDAT-S032040-Exx	5.0					0.63	
LDAT-S033010-Dxx	3.5	11.1	190 (43)	36.5	504 (113)	0.67	2198-D032-ERSx
LDAT-S033020-Dxx	4.7					0.88	
LDAT-S033030-Dxx	5.0					0.95	
LDAT-S033040-Dxx						0.95	
LDAT-S033010-Exx	3.5	3.7	190 (43)	12.2	504 (113)	0.67	2198-D012-ERSx
LDAT-S033020-Exx	4.7					0.87	
LDAT-S033030-Exx	5.0					0.91	
LDAT-S033040-Exx						0.91	

Performance specification data and curves reflect nominal system performance of a typical system with the motor ambient at 40 °C (104 °F), drive ambient at 50 °C (122 °F), and rated line voltage. For additional information on ambient and line conditions, refer to Motion Analyzer software.

Performance Specifications with Frame 50 Linear Thrusters

Linear Thruster Cat. No.	Velocity, max 460V AC m/s	System Continuous Stall Current Amps 0-pk	System Continuous Stall Force N (lb)	System Peak Stall Current Amps 0-pk	System Peak Stall Force N (lb)	Rated Output 460V AC kW	Kinetix 5700 Drives (480V AC input)
LDAT-S051010-Dxx	2.8	3.1	119 (27)	11.4	363 (82)	0.34	2198-D012-ERSx
LDAT-S051020-Dxx	3.7					0.43	
LDAT-S051030-Dxx	4.1					0.49	
LDAT-S051040-Dxx	4.4					0.53	
LDAT-S051050-Dxx	4.7					0.55	
LDAT-S052010-Dxx	3.7	6.2	251 (56)	22.7	727 (163)	0.92	2198-D020-ERSx
LDAT-S052020-Dxx	4.8					1.20	
LDAT-S052030-Dxx	5.0					1.24	
LDAT-S052040-Dxx							
LDAT-S052050-Dxx							
LDAT-S052010-Exx	3.7	3.1	11.4	11.4	1093 (246)	0.80	2198-D012-ERSx
LDAT-S052020-Exx	4.6					0.98	
LDAT-S052030-Exx	4.6					1.02	
LDAT-S052040-Exx							
LDAT-S052050-Exx							
LDAT-S053010-Dxx	4.1	9.4	378 (85)	34.2	1093 (246)	1.56	2198-D032-ERSx
LDAT-S053020-Dxx	5.0					1.87	
LDAT-S053030-Dxx ... LDAT-S053050-Dxx							
LDAT-S053010-Exx ... LDAT-S053050-Exx	3.5	3.1		11.4		1.04	2198-D012-ERSx
LDAT-S054010-Dxx	4.4	12.4	509 (114)	45.5	1453 (327)	2.26	2198-D032-ERSx
LDAT-S054020-Dxx ... LDAT-S054050-Dxx	5.00					2.53	
LDAT-S054010-Exx	4.4					6.2	
LDAT-S054020-Exx ... LDAT-S054050-Exx	5.0	2.05					

Performance specification data and curves reflect nominal system performance of a typical system with the motor ambient at 40 °C (104 °F), drive ambient at 50 °C (122 °F), and rated line voltage. For additional information on ambient and line conditions, refer to Motion Analyzer software.

Performance Specifications with Frame 70 Linear Thrusters

Linear Thruster Cat. No.	Velocity, max 460V AC m/s	System Continuous Stall Current Amps 0-pk	System Continuous Stall Force N (lb)	System Peak Stall Current Amps 0-pk	System Peak Stall Force N (lb)	Rated Output 460V AC kW	Kinetix 5700 Drives (480V AC input)
LDAT-S072010-Dxx	3.9	6.0	364 (82)	22.0	1055 (237)	1.37	2198-D020-ERSx
LDAT-S072020-Dxx	5.0					1.64	
LDAT-S072030-Dxx ... LDAT-S072070-Dxx							
LDAT-S072010-Exx	3.5	3.0		11.0		1.03	2198-D012-ERSx
LDAT-S072020-Exx							
LDAT-S072070-Exx							
LDAT-S073010-Dxx	4.4	9.0	554 (125)	32.8	1576 (354)	2.27	2198-D032-ERSx
LDAT-S073020-Dxx	5.0					2.50	
LDAT-S073070-Dxx							
LDAT-S073010-Exx	2.4	3.0		10.9		1.01	2198-D012-ERSx
LDAT-S073070-Exx							
LDAT-S074010-Dxx	4.7	11.9	730 (164)	43.5	2088 (469)	3.15	2198-D032-ERSx
LDAT-S074020-Dxx	5.0					3.30	
LDAT-S074070-Dxx							
LDAT-S074010-Exx	3.5	6.0		21.7		2.08	2198-D020-ERSx
LDAT-S074070-Exx							
LDAT-S076010-Dxx	5.0	18.2	1122 (252)	66.4	3189 (717)	5.02	2198-D057-ERSx
LDAT-S076020-Dxx							
LDAT-S076070-Dxx							
LDAT-S076010-Exx	3.5	9.1		33.2		3.18	2198-D032-ERSx
LDAT-S076070-Exx							

Performance specification data and curves reflect nominal system performance of a typical system with the motor ambient at 40 °C (104 °F), drive ambient at 50 °C (122 °F), and rated line voltage. For additional information on ambient and line conditions, refer to Motion Analyzer software.

Performance Specifications with Frame 100 Linear Thrusters

Linear Thruster Cat. No.	Velocity, max 460V AC m/s	System Continuous Stall Current Amps 0-pk	System Continuous Stall Force N (lb)	System Peak Stall Current Amps 0-pk	System Peak Stall Force N (lb)	Rated Output 460V AC kW	Kinetix 5700 Drives (480V AC input)
LDAT-S102010-Dxx	3.4	5.7	456 (103)	21.0	1289 (290)	1.44	2198-D020-ERSx
LDAT-S102020-Dxx	4.4					1.74	
LDAT-S102030-Dxx	5.0					1.91	
LDAT-S102040-Dxx							
LDAT-S102050-Dxx ... LDAT-S102090-Dxx							
LDAT-S102010-Exx ... LDAT-S102090-Exx	2.6	2.9	10.5	0.96	2198-D012-ERSx		
LDAT-S103010-Dxx	3.8	8.6	702 (158)	31.5	1935 (435)	2.41	2198-D032-ERSx
LDAT-S103020-Dxx	5.0					2.93	
LDAT-S103030-Dxx ... LDAT-S103090-Dxx							
LDAT-S103010-Exx ... LDAT-S103090-Exx	1.8	2.9	10.5	0.92	2198-D012-ERSx		
LDAT-S104010-Dxx	4.1	11.5	929 (209)	42.0	2578 (580)	3.76	2198-D032-ERSx
LDAT-S104020-Dxx	5.0					4.29	
LDAT-S104030-Dxx ... LDAT-S104090-Dxx							
LDAT-S104010-Exx ... LDAT-S104090-Exx	2.7	5.7	21.0	2.07	2198-D020-ERSx		
LDAT-S106010-Dxx	4.5	17.3	1403 (315)	63.0	3871 (870)	5.41	2198-D057-ERSx
LDAT-S106020-Dxx ... LDAT-S106090-Dxx	5.0					5.87	
LDAT-S106010-Exx ... LDAT-S106090-Exx	2.7					8.6	

Performance specification data and curves reflect nominal system performance of a typical system with the motor ambient at 40 °C (104 °F), drive ambient at 50 °C (122 °F), and rated line voltage. For additional information on ambient and line conditions, refer to Motion Analyzer software.

Performance Specifications with Frame 150 Linear Thrusters

Linear Thruster Cat. No.	Velocity, max 460V AC m/s	System Continuous Stall Current Amps 0-pk	System Continuous Stall Force N (lb)	System Peak Stall Current Amps 0-pk	System Peak Stall Force N (lb)	Rated Output 460V AC kW	Kinetix 5700 Drives (480V AC input)
LDAT-S152010-Dxx	3.2	5.3	643 (145)	19.5	1799 (404)	1.76	2198-D020-ERSx
LDAT-S152020-Dxx ... LDAT-S152090-Dxx	3.5					1.89	
LDAT-S152010-Exx ... LDAT-S152090-Exx	1.8	2.7	978 (220)	9.8	2680 (602)	0.87	2198-D012-ERSx
LDAT-S153010-Dxx ... LDAT-S153090-Dxx	3.6	8.0		29.1		2.87	2198-D032-ERSx
LDAT-S153010-Exx ... LDAT-S153090-Exx	1.2	2.7	1306 (294)	9.1	3597 (809)	0.80	2198-D012-ERSx
LDAT-S154010-Dxx ... LDAT-S154090-Dxx	3.5	10.7		39.1		3.83	2198-D032-ERSx
LDAT-S154010-Exx ... LDAT-S154090-Exx	1.8	5.3	1997 (449)	19.5	5469 (1229)	1.78	2198-D020-ERSx
LDAT-S156010-Dxx ... LDAT-S156090-Dxx	3.6	16.3		59.4		5.85	2198-D057-ERSx
LDAT-S156010-Exx ... LDAT-S156090-Exx	1.8	8.1	1997 (449)	19.8	5469 (1229)	2.71	2198-D020-ERSx

Performance specification data and curves reflect nominal system performance of a typical system with the motor ambient at 40 °C (104 °F), drive ambient at 50 °C (122 °F), and rated line voltage. For additional information on ambient and line conditions, refer to Motion Analyzer software.

Kinetix 5700 (400V-class) Drives/LDAT-Series Integrated Linear Thruster Curves

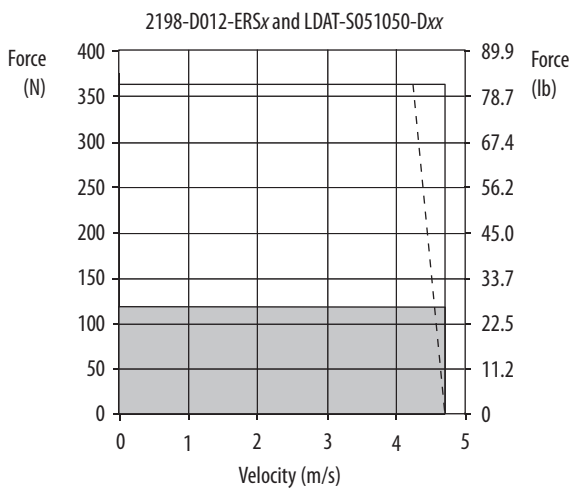
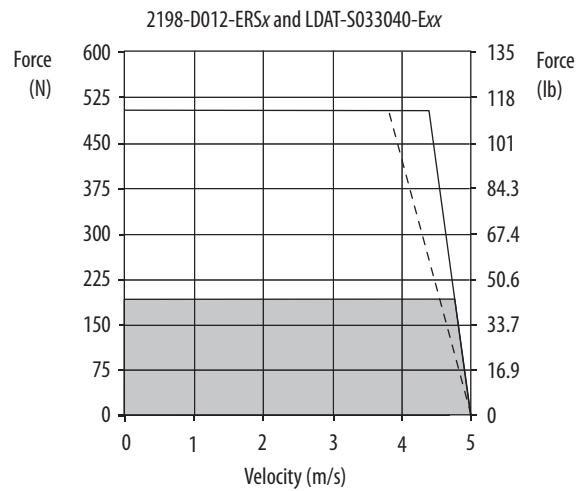
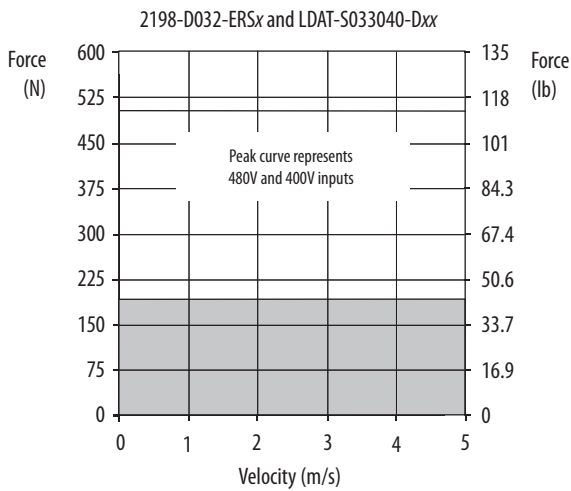
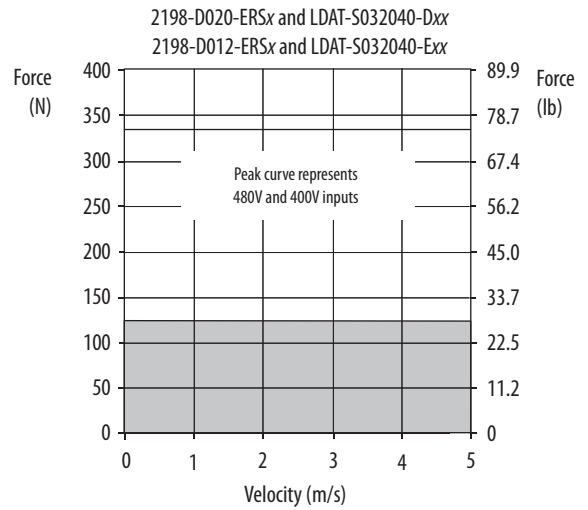
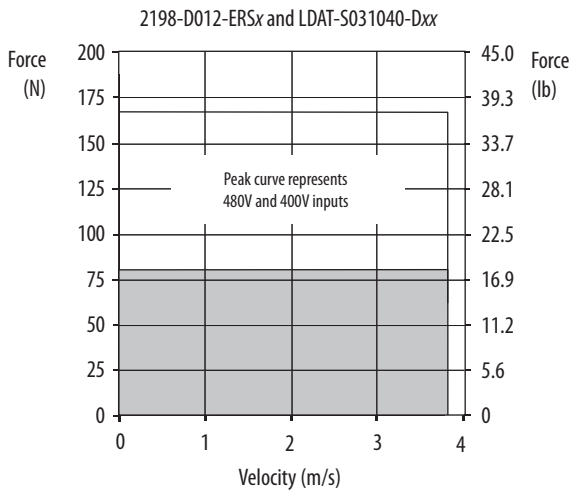

- = Intermittent operating region
- = Continuous operating region
- = Drive operation with 400V AC input voltage

Kinetix 5700 (400V-class) Drives/LDAT-Series Linear Thruster Curves (continued)

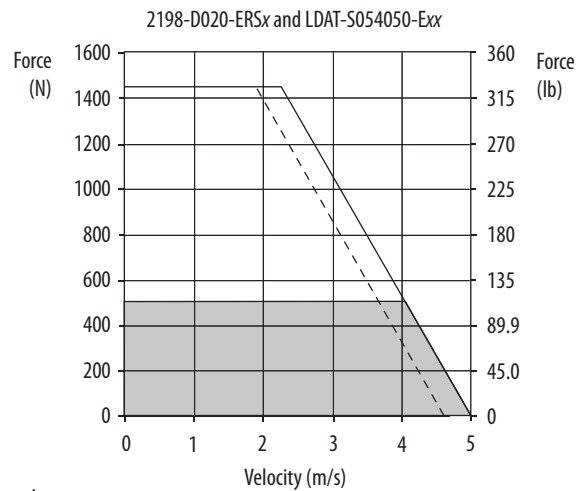
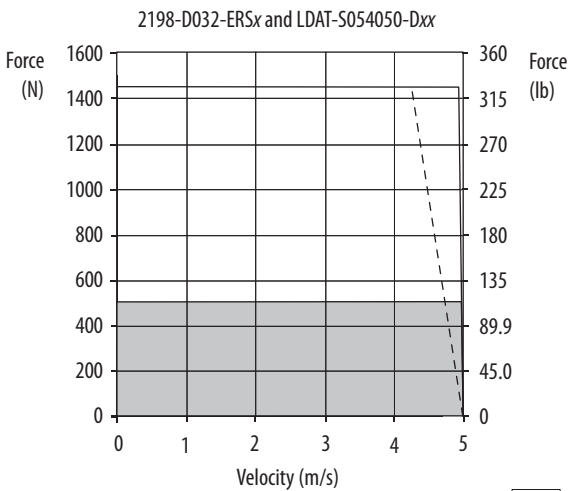
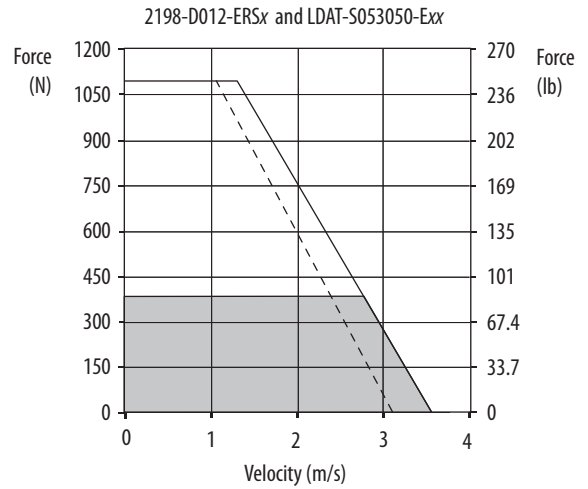
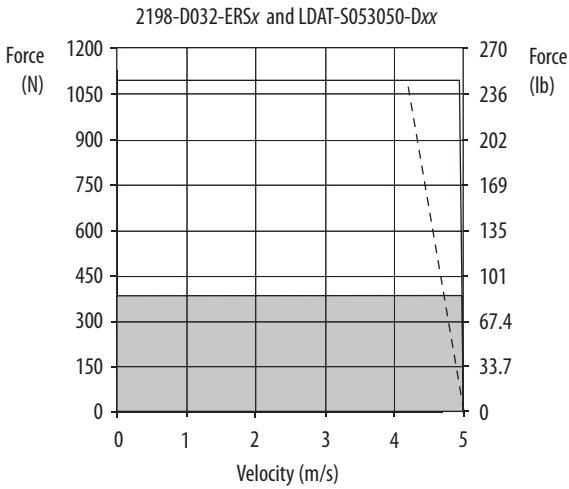
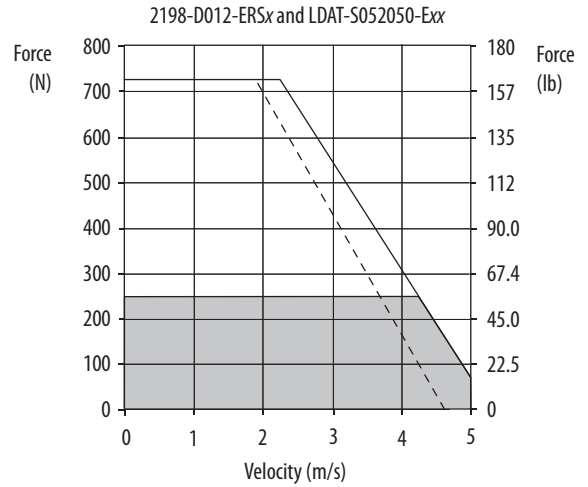
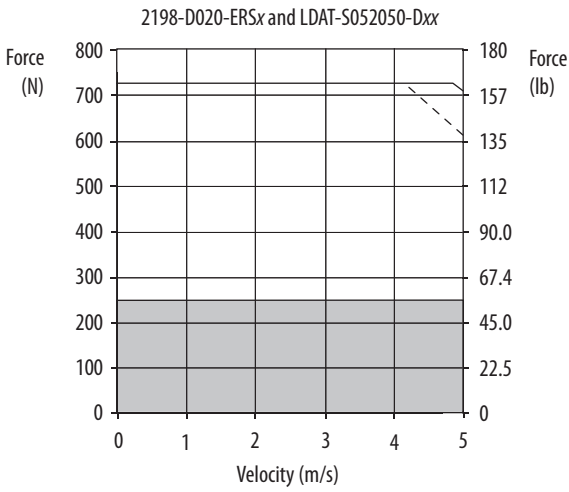

= Intermittent operating region
 = Continuous operating region
 = Drive operation with 400V AC input voltage

Kinetix 5700 (400V-class) Drives/LDAT-Series Linear Thruster Curves (continued)

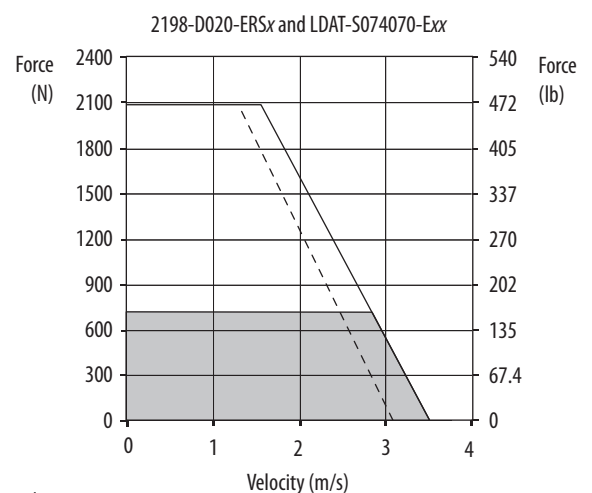
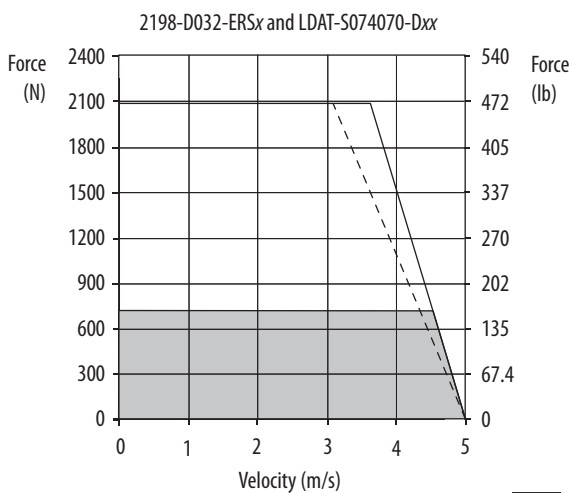
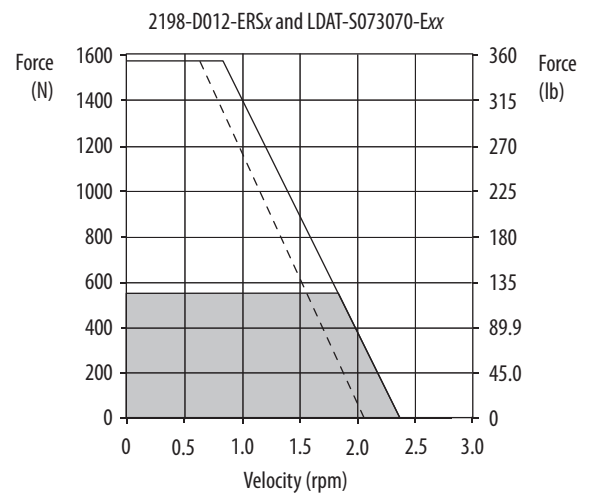
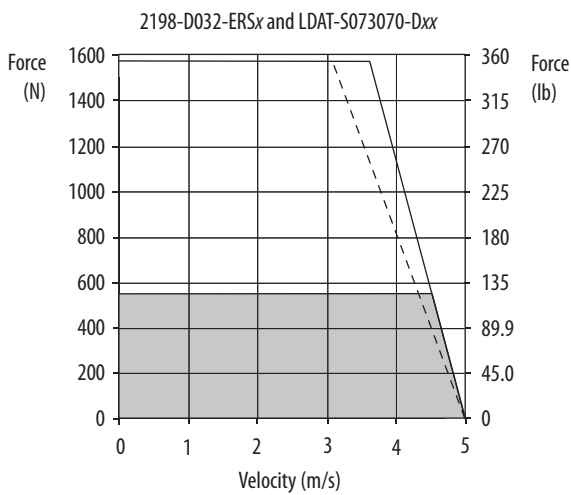
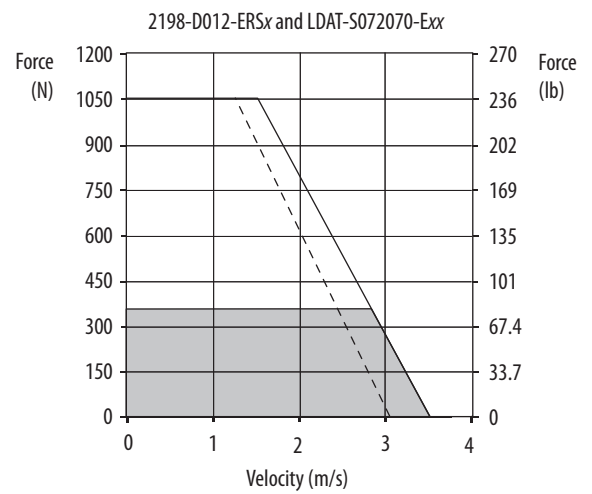
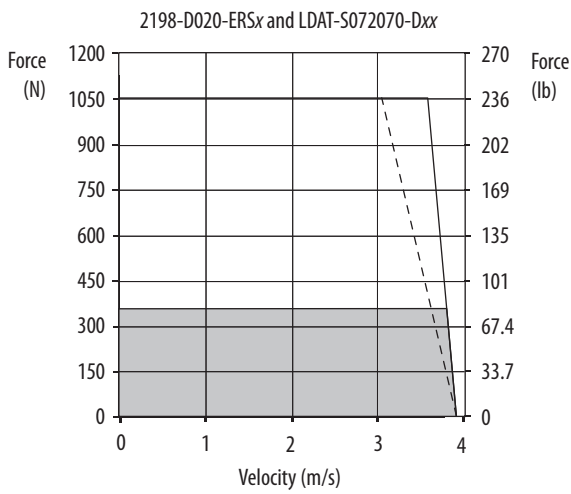

- = Intermittent operating region
- = Continuous operating region
- = Drive operation with 400V AC input voltage

Kinetix 5700 (400V-class) Drives/LDAT-Series Linear Thruster Curves (continued)

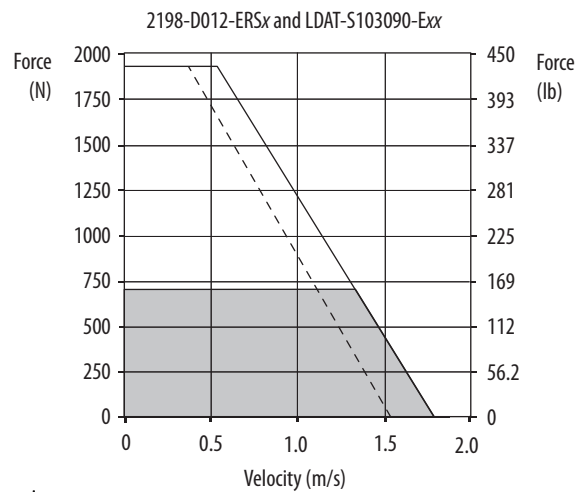
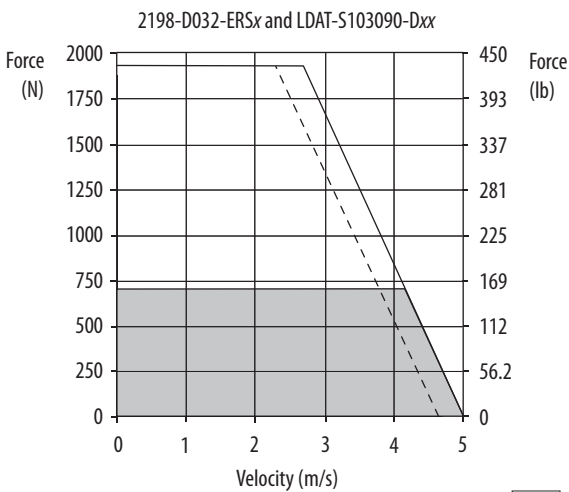
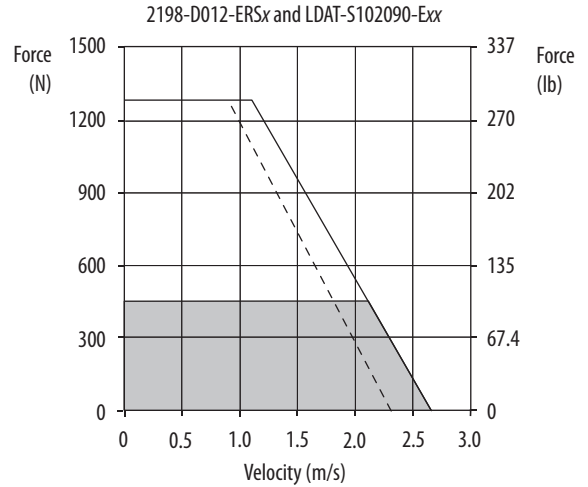
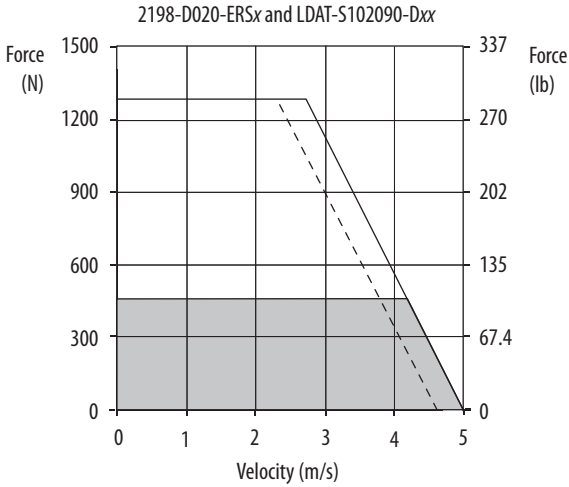
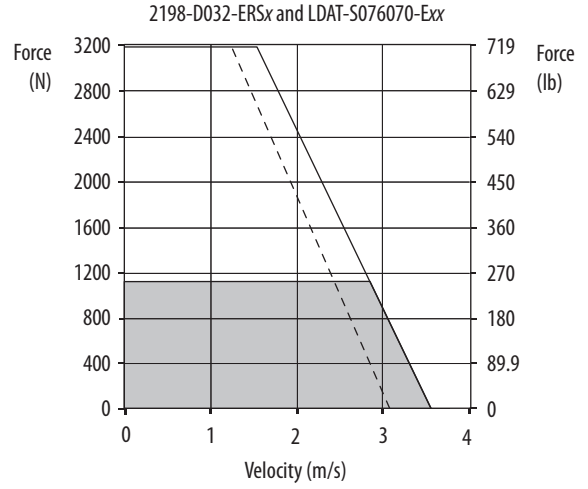
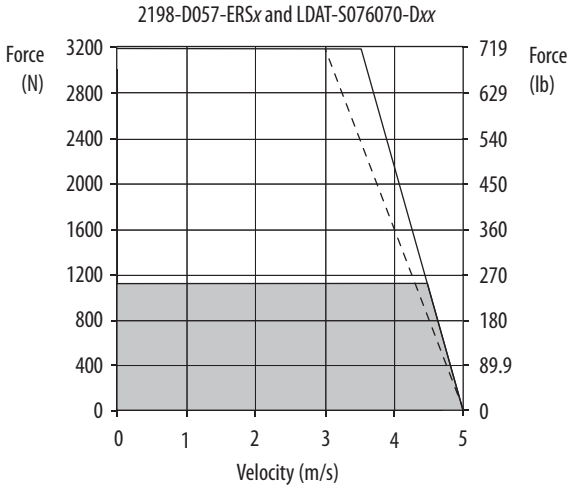

= Intermittent operating region
 = Continuous operating region
 = Drive operation with 400V AC input voltage

Kinetix 5700 (400V-class) Drives/LDAT-Series Linear Thruster Curves (continued)

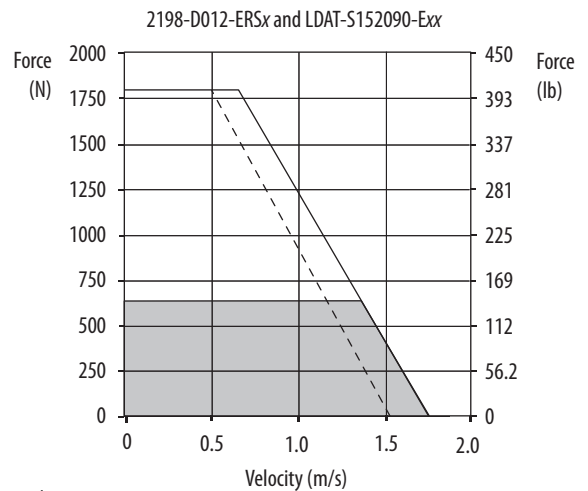
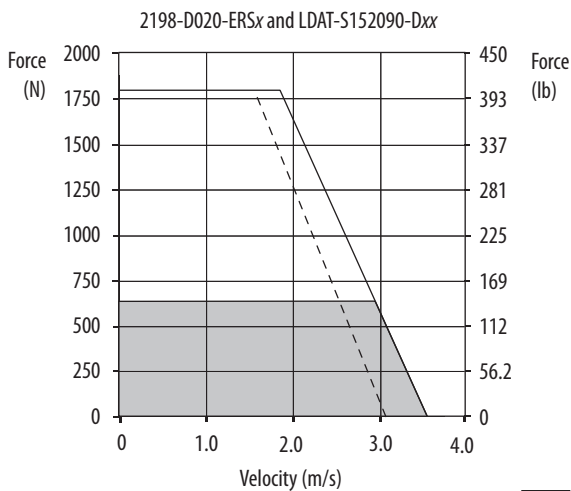
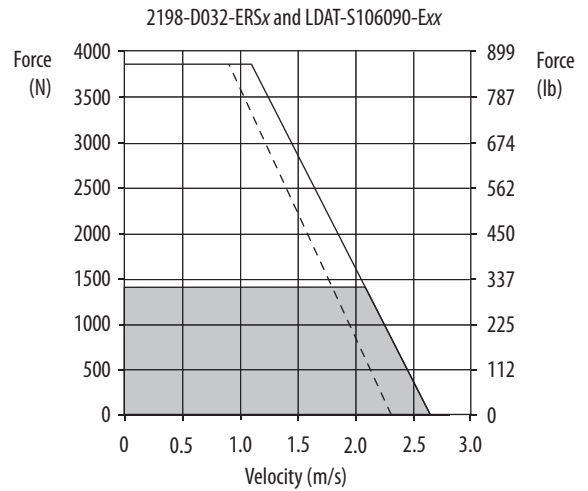
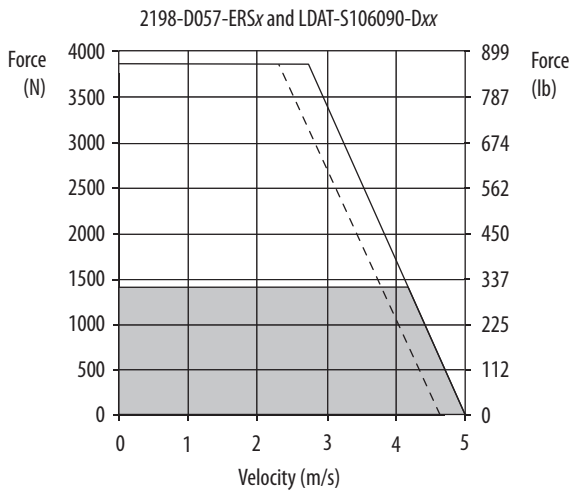
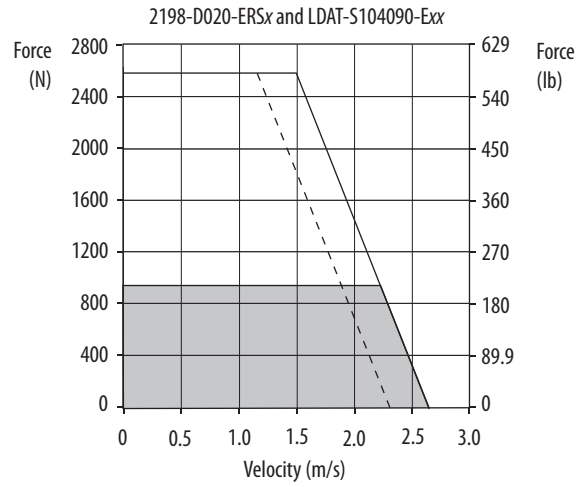
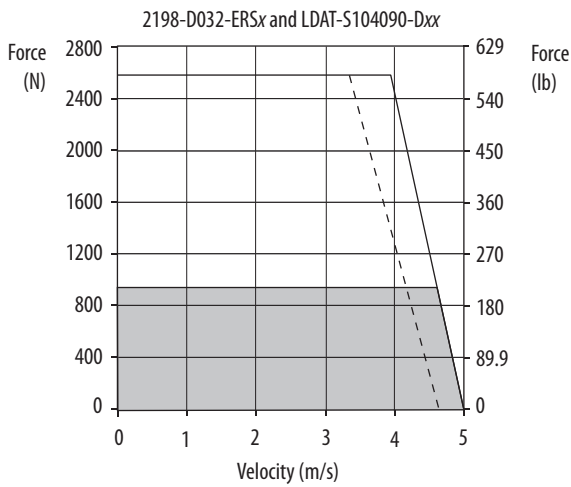

= Intermittent operating region
 = Continuous operating region
 = Drive operation with 400V AC input voltage

Kinetix 5700 (400V-class) Drives/LDAT-Series Linear Thruster Curves (continued)

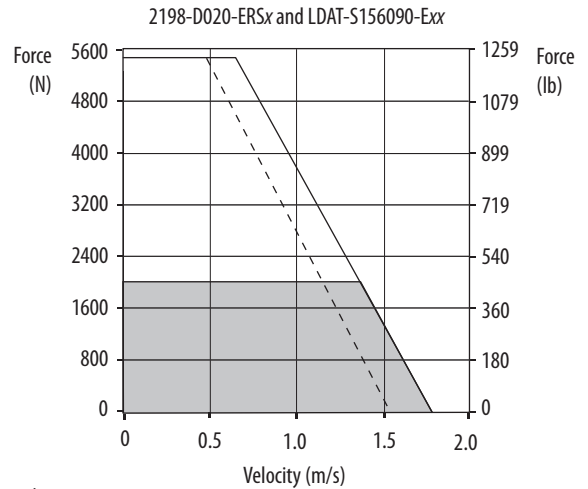
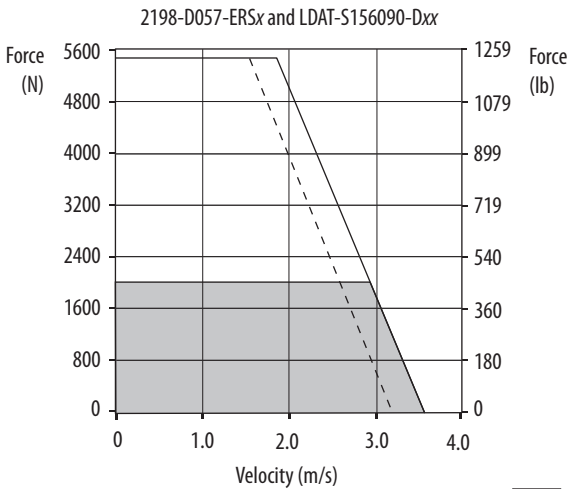
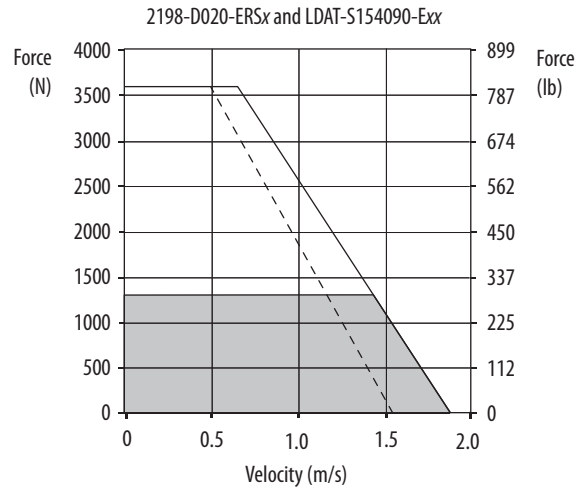
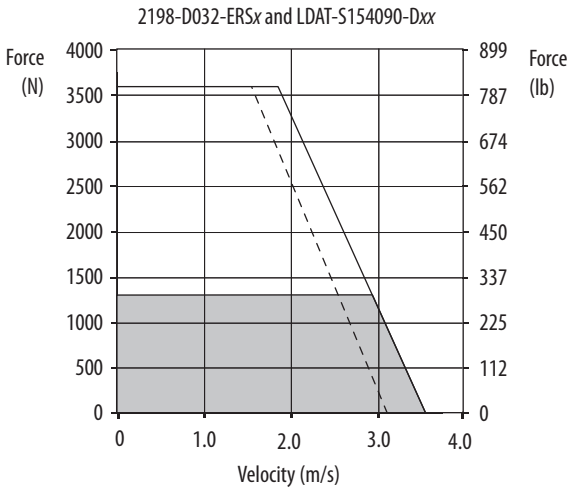
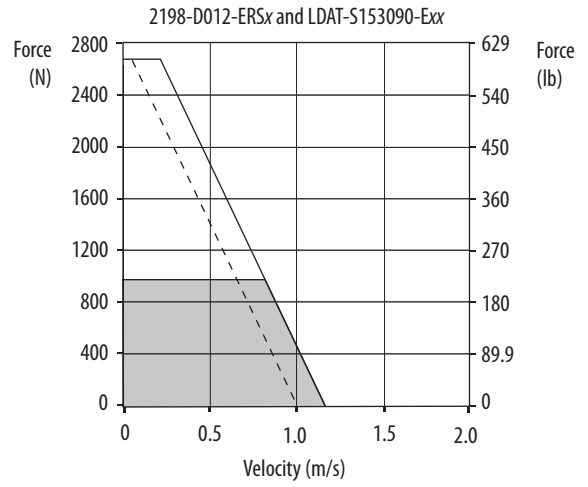
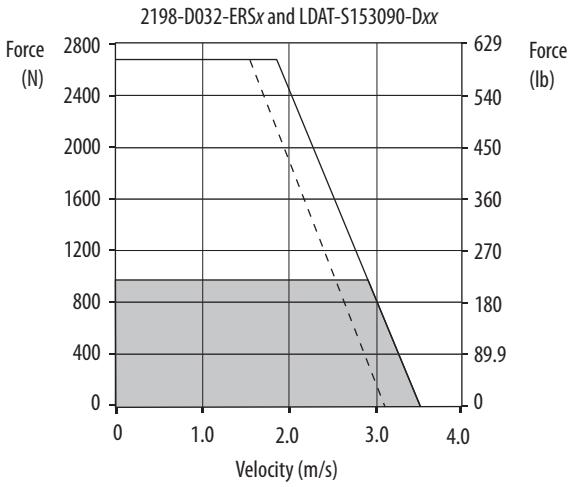

= Intermittent operating region
 = Continuous operating region
 = Drive operation with 400V AC input voltage

Kinetix 5700 (400V-class) Drives with Kinetix MPAS Integrated Linear Stages

This section provides system combination information for the Kinetix 5700 drives (with 400 and 480V, nominal input) when matched with Kinetix MPAS (400V-class) linear stages. Included are motor power/brake and feedback cable catalog numbers, system performance specifications, and the optimum force/velocity curves.

Kinetix MPAS Cable Combinations

Linear Stage Cat. No. (400V-class)	Motor Power/Brake Cable	Motor Feedback Cable ⁽¹⁾
MPAS-Bxxxx1-V05SxA ⁽²⁾ MPAS-Bxxxx2-V20SxA	2090-CPxM7DF-16AAxx (standard, non-flex) 2090-CPxM7DF-16AFxx (continuous-flex)	2090-CFBM7DF-CEAAxx (standard, non-flex) 2090-CFBM7DF-CEAFxx (continuous-flex) Absolute High-resolution Feedback
MPAS-B8xxxx-ALMx2C ⁽³⁾ MPAS-B9xxxx-ALMx2C		2090-XXNFMF-Sxx (standard, non-flex) 2090-CFBM7DF-CDAFxx (continuous-flex) Incremental Feedback

(1) Use the 2198-K57CK-D15M feedback connector kit or 2198-H2DCK Hiperface-to-DSL converter kit with flying-lead cables on the drive end. Refer to Required Drive Accessories on [page 11](#).

(2) Use either (2198-K57CK-D15M or 2198-H2DCK) kit with MPAS-Bxxxx1-V05SxA (ballscrew) linear stages.

(3) Use only the 2198-K57CK-D15M kit with MPAS-B8xxxx-ALMx2C (direct-drive) linear stages.

For cable configuration illustrations and feature descriptions, by catalog number, refer to 2090-Series Motor Power/Brake and Feedback Cables Overview beginning on [page 19](#).

Motor-end connector kits are available for motor power/brake and feedback cables. Refer to the Kinetix Motion Accessories Technical Data, publication [KNX-TD004](#), for connector kit catalog numbers and cable specifications. Cable length xx is in meters. For information on maximum cable lengths see Kinetix 5700 Servo Drives User Manual, publication [2198-UM002](#).

Kinetix MPAS Performance Specifications with Kinetix 5700 (400V-class) Drives

Linear Stage Cat. No.	Maximum Speed mm/s (in/s)	System Continuous Stall Current Amps 0-pk	System Continuous Stall Force N (lb)	System Peak Stall Current Amps 0-pk	System Peak Stall Force N (lb)	Motor Output Power Rating kW	Kinetix 5700 Drives (480V AC operation)
MPAS-Bxxxx1-V05SxA	200 (7.9) ⁽¹⁾	1.75	521 (117)	3.50	1212 (272)	0.37	2198-D006-ERSx
MPAS-Bxxxx2-V20SxA	1124 (44.3) ⁽²⁾	3.30	462 (104)	6.60	968 (218)	0.62	2198-D006-ERSx
MPAS-B8xxxF-ALM02C	5000 (200)	3.50	189 (42.5)	9.30	456 (103)	0.527	2198-D012-ERSx
MPAS-B8xxxL-ALMS2C	5000 (200)	3.15	159 (35.7)	8.37	399 (89.7)	0.475	2198-D006-ERSx
MPAS-B9xxxL-ALM02C	5000 (200)	3.40	285 (64.1)	9.10	680 (153)	0.768	2198-D012-ERSx
MPAS-B9xxxL-ALMS2C	5000 (200)	3.03	245 (55.1)	8.19	601 (135)	0.69	2198-D006-ERSx

(1) For 900 mm stroke length, maximum speed is 176 mm/s (6.9 in/s). For 1020 mm stroke length, maximum speed is 143 mm/s (5.6 in/s).

(2) For 780 mm stroke length, maximum speed is 889 mm/s (35.0 in/s). For 900 mm stroke length, maximum speed is 715 mm/s (28.2 in/s). For 1020 mm stroke length, maximum speed is 582 mm/s (22.9 in/s).

Performance specification data and curves reflect nominal system performance of a typical system with the motor ambient at 40 °C (104 °F), drive ambient at 50 °C (122 °F), and rated line voltage. For additional information on ambient and line conditions, refer to Motion Analyzer software.

Kinetix 5700 (400V-class) Drives/Kinetix MPAS Linear Stage Curves

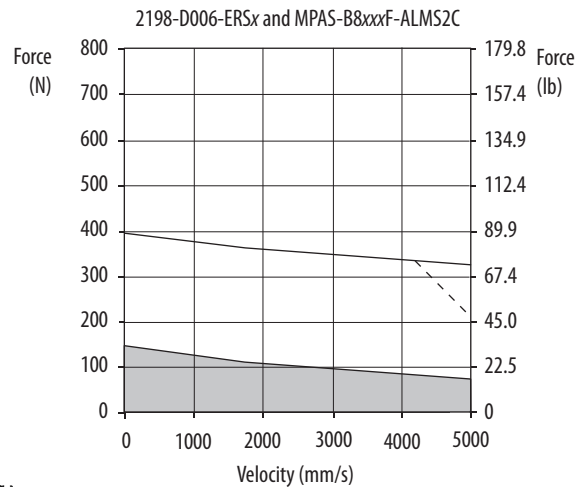
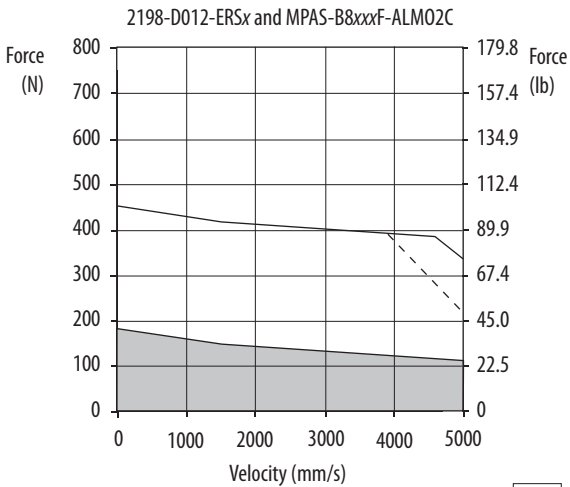
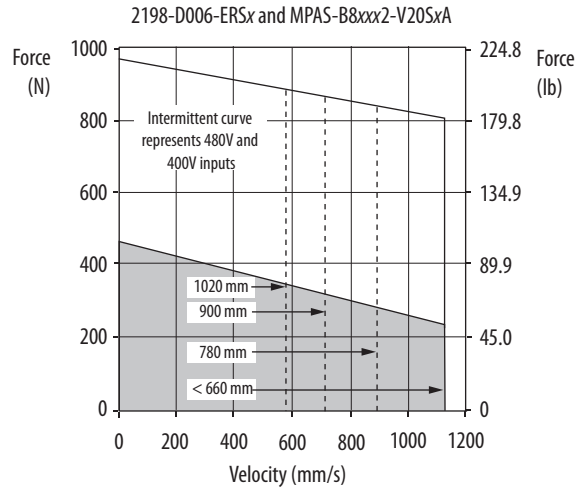
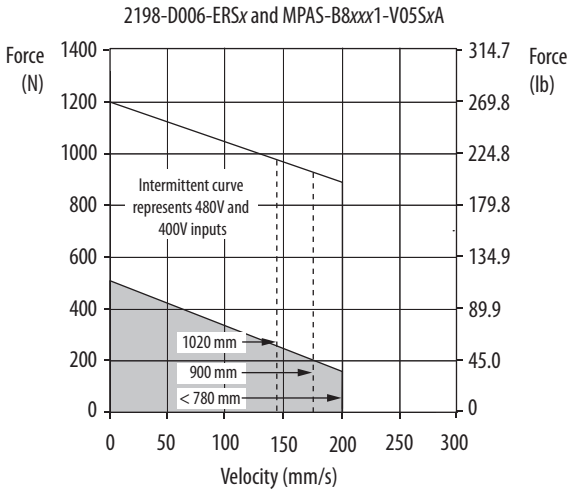
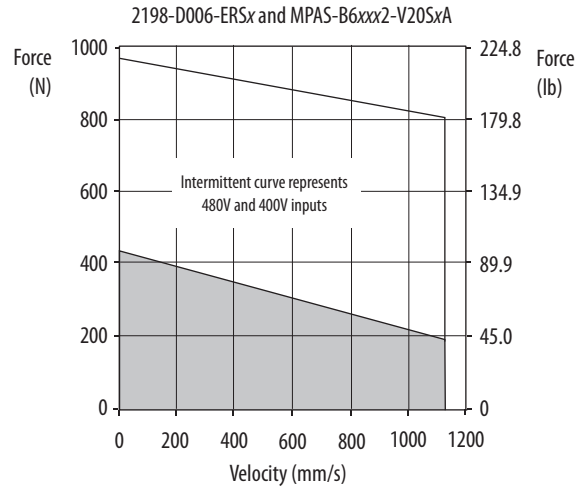
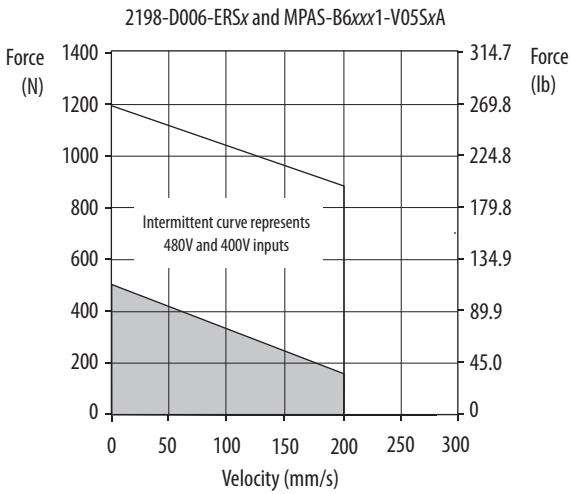

- = Intermittent operating region
- = Continuous operating region
- = System operation with 400V AC rms input voltage
- = System operation for specified stroke length

Kinetix 5700 (400V-class) Drives/Kinetix MPAS Linear Stage Curves (continued)

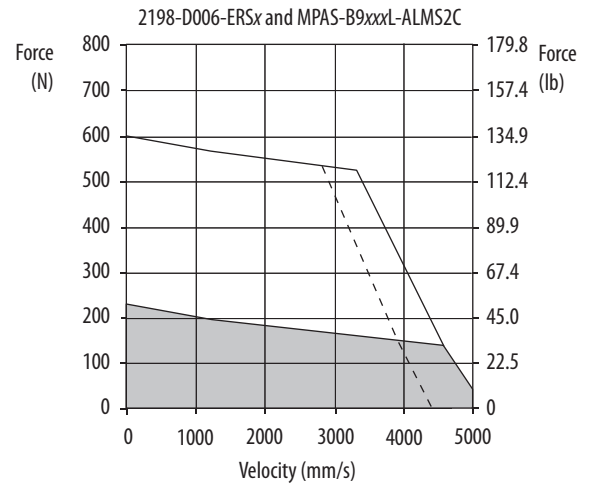
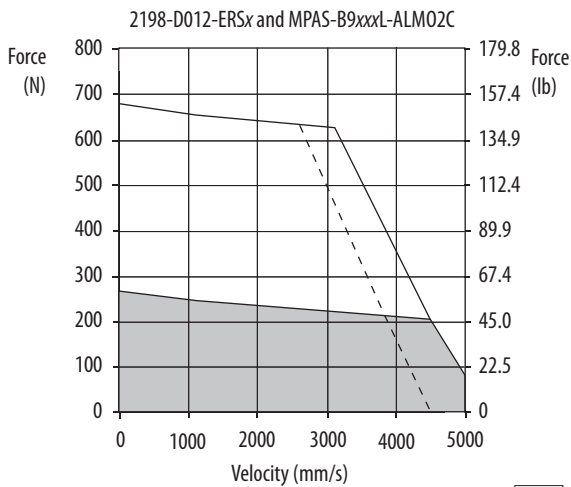
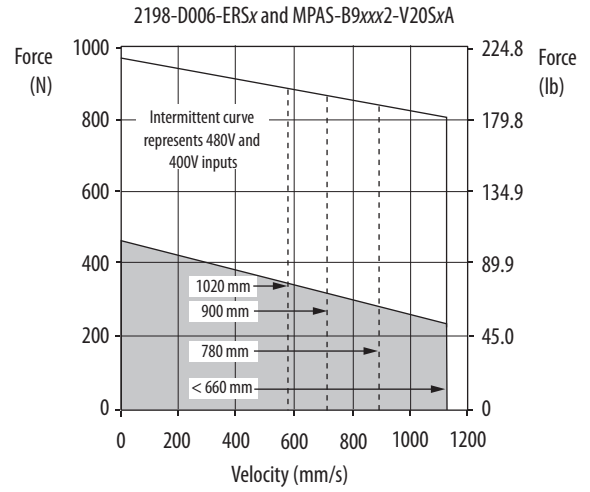
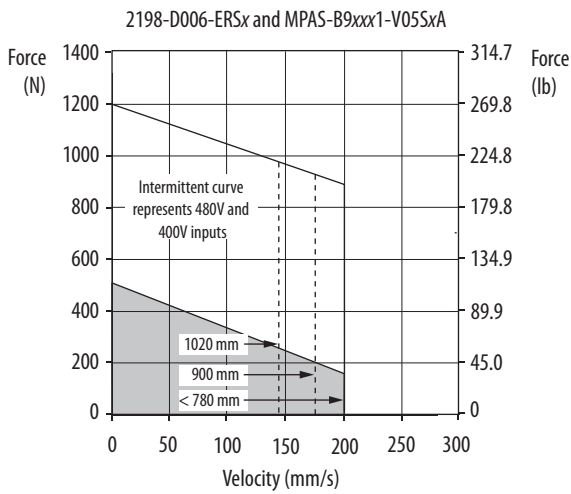

- = Intermittent operating region
- = Continuous operating region
- = System operation with 400V AC rms input voltage
- = System operation for specified stroke length

Kinetix 5700 Drives with Kinetix VPAR Electric Cylinders

This section provides system combination information for the Kinetix 5700 drives (with 480V, nominal input) when matched with Kinetix VPAR electric cylinders. Included are motor power/brake and feedback cable catalog numbers, system performance specifications, and the optimum force/velocity curves.

Kinetix VPAR Cable Combinations

Electric Cylinder Cat. No. (400V-class) ⁽¹⁾	Single Motor Cable ⁽²⁾	Feedback Type
VPAR-B1xxxB-x VPAR-B1xxxE-x VPAR-B2xxxC-x VPAR-B2xxxF-x	2090-CSBM1Dx-18xAxx or 2090-CSWM1Dx-18xAxx (standard, non-flex) 2090-CSBM1Dx-18xFxx (continuous-flex)	Absolute, Multi-turn Digital Encoder • SIL 2/PLd Rated • Hiperface DSL Protocol
VPAR-B3xxxE-x VPAR-B3xxxH-x	2090-CSBM1Dx-14xAxx or 2090-CSWM1Dx-14xAxx (standard, non-flex) 2090-CSBM1Dx-14xFxx (continuous-flex)	

(1) Encoder options for VPAR-Bxxxx electric cylinders are -Q and -W (absolute multi-turn digital encoder, Hiperface DSL protocol) SIL 2 (PLd) rated, and -P (absolute multi-turn digital encoder, Hiperface DSL protocol).

(2) Use 2090-CSM1DE or 2090-CSM1DG cables. Cable length xx is in meters, 01 (3.3) ... 90 (265) in 1.0 m (3.3 ft) increments. For information on maximum cable lengths see Kinetix 5700 Servo Drives User Manual, publication [2198-UM002](#). Refer to the Kinetix Motion Accessories Technical Data, publication [KNX-TD004](#), for cable specifications. For cable configuration illustrations and feature descriptions, by catalog number, refer to 2090-Series Single Motor Cable Overview beginning on [page 18](#).

Kinetix VPAR Performance Specifications with Kinetix 5700 Drives

Performance Specifications with Kinetix 5700 (400V-class) Drives

Electric Cylinder Cat. No.	Maximum Speed mm/s (in/s)	System Continuous Stall Current Amps 0-pk	System Continuous Stall Force N (lb)	System Peak Stall Current Amps 0-pk	System Peak Stall Force N (lb)	Motor Output Power Rating kW	Kinetix 5700 Drives (480V AC input)
VPAR-B1xxxB	150	0.41	240 (53.9)	1.34	300 (67.4)	0.11	2198-D006-ERSx
VPAR-B1xxxE	500	1.20	280 (62.9)	2.10	350 (78.7)	0.24	2198-D006-ERSx
VPAR-B2xxxC	250	1.25	420 (94.4)	2.67	525 (118)	0.25	2198-D006-ERSx
VPAR-B2xxxF	640	3.10	640 (144)	5.80	800 (180)	0.56	2198-D012-ERSx
VPAR-B3xxxE	500	5.10	2000 (450)	13.0	2500 (562)	1.30	2198-D012-ERSx
VPAR-B3xxxH	1000	8.60	1284 (289)	17.0	1625 (365)	1.68	2198-D020-ERSx

Performance specification data and curves reflect nominal system performance of a typical system with the motor ambient at 40 °C (104 °F), drive ambient at 50 °C (122 °F), and rated line voltage. For additional information on ambient and line conditions, refer to Motion Analyzer software.

Kinetix 5700 Drives/Kinetix VPAR Electric Cylinder Curves

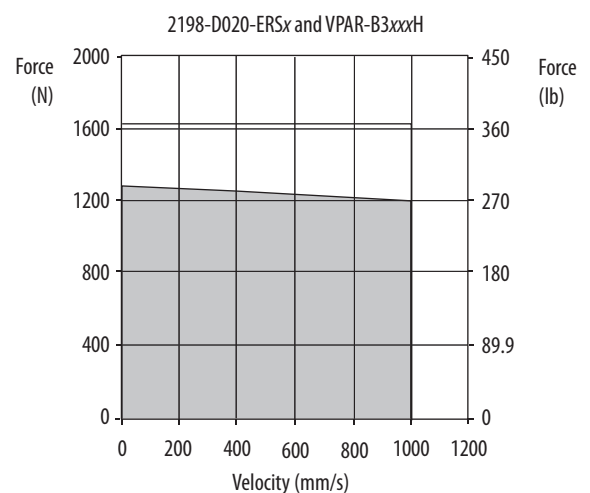
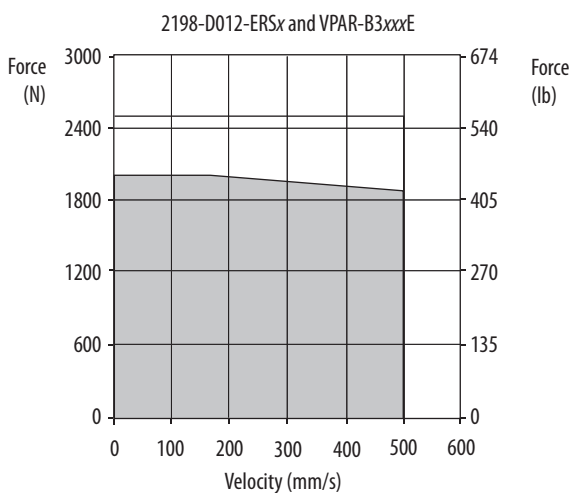
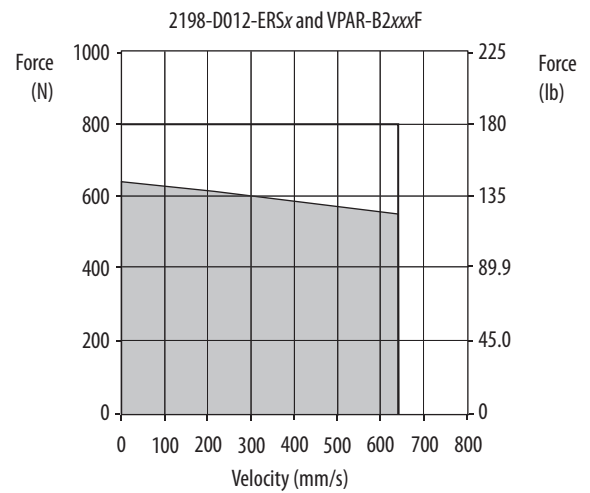
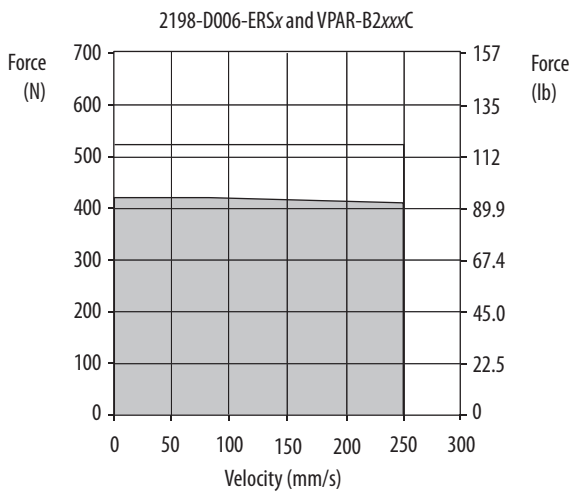
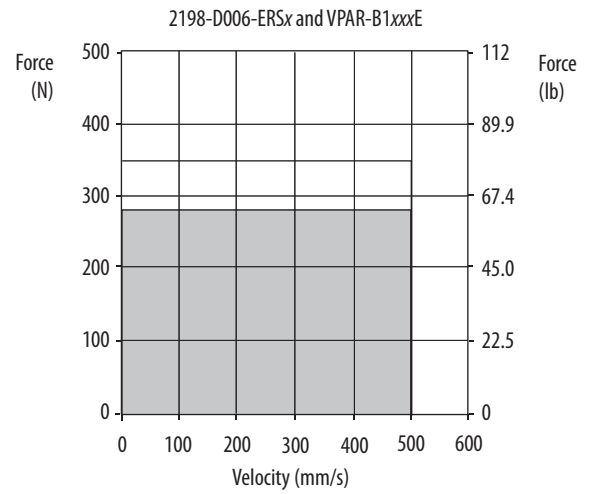
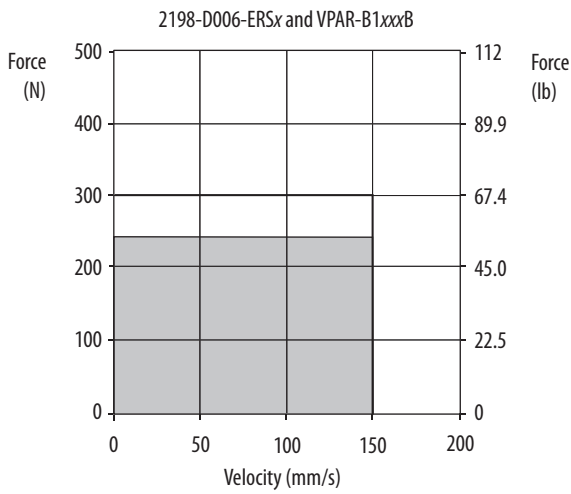

= Intermittent operating region
 = Continuous operating region

Kinetix 5700 Drives with Kinetix MPAR Electric Cylinders

This section provides system combination information for the Kinetix 5700 drives (with 480V, nominal input) when matched with Kinetix MPAR electric cylinders. Included are motor power/brake and feedback cable catalog numbers, system performance specifications, and the optimum force/velocity curves.

Kinetix MPAR Cable Combinations

Electric Cylinder Cat. No. (400V-class)	Motor Power/Brake Cable	Motor Feedback Cable ⁽¹⁾
MPAR-B1xxxB, MPAR-B1xxxE MPAR-B2xxxC, MPAR-B2xxxF MPAR-B3xxxE, MPAR-B3xxxH	2090-CPxM7DF-16AAxx (standard, non-flex) 2090-CPxM7DF-16AFxx (continuous-flex)	2090-CFBM7DF-CEAAxx (standard, non-flex) 2090-CFBM7DF-CEAFxx (continuous-flex) Absolute High-resolution Feedback

(1) Use the 2198-K57CK-D15M feedback connector kit or 2198-H2DCK Hiperface-to-DSL converter kit with flying-lead cables on the drive end. Refer to Required Drive Accessories on [page 11](#).

For cable configuration illustrations and feature descriptions, by catalog number, refer to 2090-Series Motor Power/Brake and Feedback Cables Overview beginning on [page 19](#).

Motor-end connector kits are available for motor power/brake and feedback cables. Refer to the Kinetix Motion Accessories Technical Data, publication [KNX-TD004](#), for connector kit catalog numbers and cable specifications. Cable length xx is in meters. For information on maximum cable lengths see Kinetix 5700 Servo Drives User Manual, publication [2198-UM002](#).

Kinetix MPAR Performance Specifications with Kinetix 5700 Drives

Performance Specifications with Kinetix 5700 (400V-class) Drives

Electric Cylinder Cat. No.	Maximum Speed mm/s (in/s)	System Continuous Stall Current Amps 0-pk	System Continuous Stall Force N (lb)	System Peak Stall Current Amps 0-pk	System Peak Stall Force N (lb)	Motor Output Power Rating kW	Kinetix 5700 Drives (480V AC input)
MPAR-B1xxxB	150	1.15	240 (53.9)	1.35	300 (67.4)	0.036	2198-D006-ERSx
MPAR-B1xxxE	500	1.49	280 (62.9)	1.71	350 (78.7)	0.140	2198-D006-ERSx
MPAR-B2xxxC	250	1.67	420 (94.4)	1.90	525 (118)	0.105	2198-D006-ERSx
MPAR-B2xxxF	640	3.29	640 (144)	3.93	800 (180)	0.410	2198-D006-ERSx
MPAR-B3xxxE	500	5.16	2000 (450)	6.17	2500 (562)	1.00	2198-D012-ERSx
MPAR-B3xxxH	1000	6.13	1300 (292)	6.79	1625 (365)	1.30	2198-D012-ERSx

Performance specification data and curves reflect nominal system performance of a typical system with the motor ambient at 40 °C (104 °F), drive ambient at 50 °C (122 °F), and rated line voltage. For additional information on ambient and line conditions, refer to Motion Analyzer software.

Kinetix 5700 Drives/Kinetix MPAR Electric Cylinder Curves

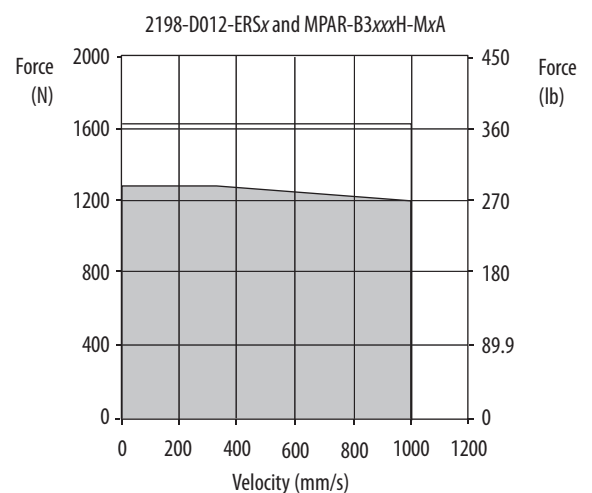
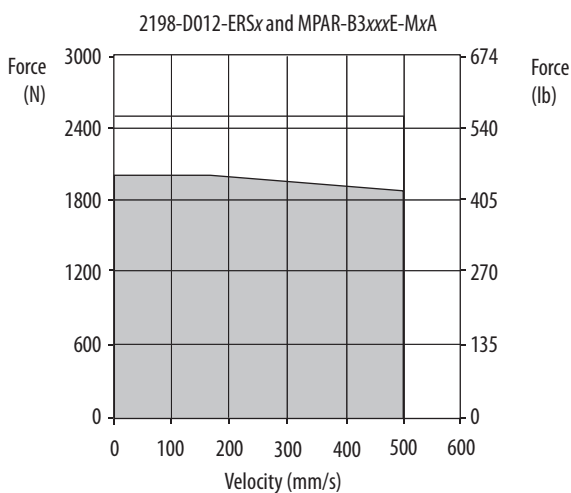
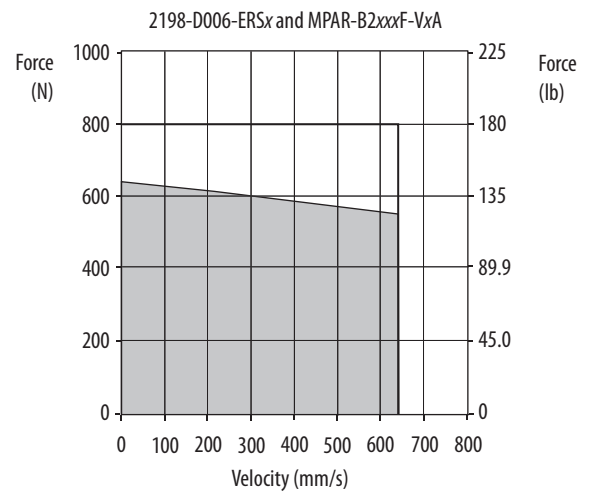
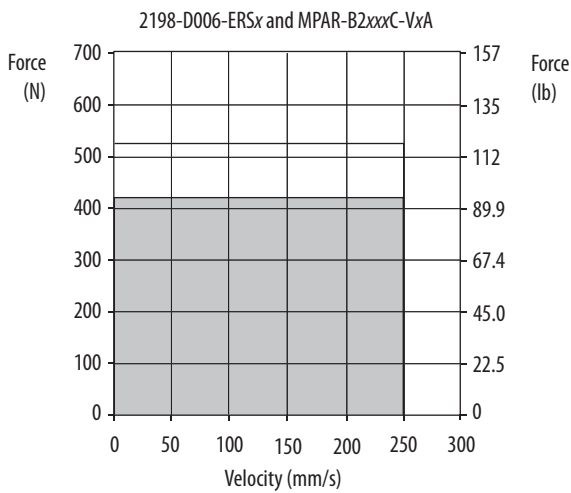
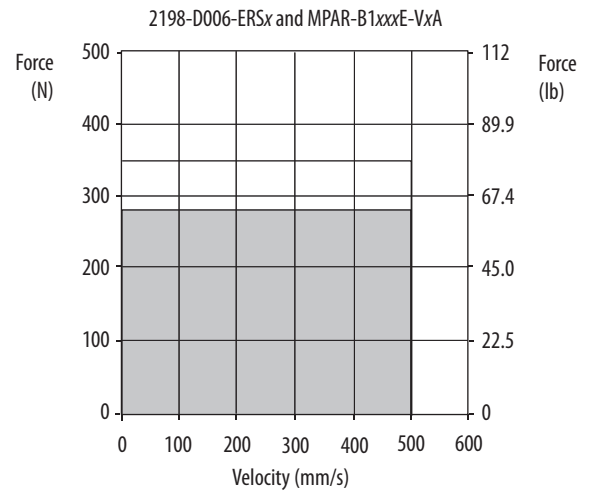
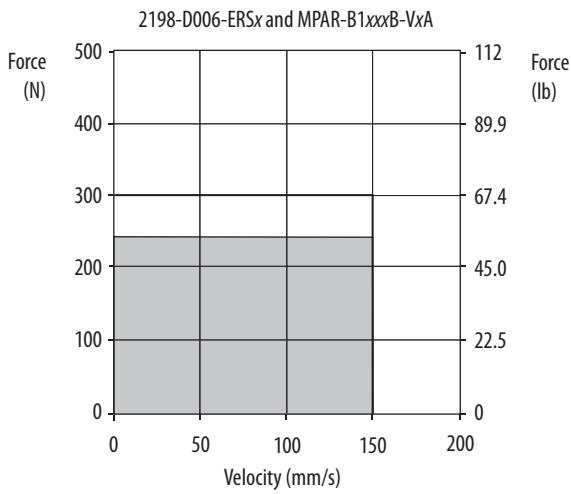

= Intermittent operating region
 = Continuous operating region

Kinetix 5700 Drives with Kinetix MPAI Heavy-duty Electric Cylinders

This section provides system combination information for the Kinetix 5700 drives (with 480V, nominal input) when matched with Kinetix MPAI electric cylinders. Included are motor power/brake and feedback cable catalog numbers, system performance specifications, and the optimum force/velocity curves.

Kinetix MPAI Cable Combinations

Electric Cylinder Cat. No. (400V-class)	Motor Power/Brake Cable	Motor Feedback Cable ⁽¹⁾
MPAI-B2xxxC	2090-CPxM7DF-16AAxx (standard, non-flex) 2090-CPxM7DF-16AFxx (continuous-flex)	2090-CFBM7DF-CEAAxx (standard, non-flex) 2090-CFBM7DF-CEAFxx (continuous-flex) Absolute High-resolution Feedback
MPAI-B3xxxC, MPAI-B3xxxE MPAI-B3xxxR, MPAI-B3xxxS		
MPAI-B4xxxC, MPAI-B4xxxE MPAI-B4xxxR, MPAI-B4xxxS		
MPAI-B5xxxC, MPAI-B5xxxE		

(1) Use the 2198-K57CK-D15M feedback connector kit or 2198-H2DCK Hiperface-to-DSL converter kit with flying-lead cables on the drive end. Refer to Required Drive Accessories on [page 11](#).

For cable configuration illustrations and feature descriptions, by catalog number, refer to 2090-Series Motor Power/Brake and Feedback Cables Overview beginning on [page 19](#).

Motor-end connector kits are available for motor power/brake and feedback cables. Refer to the Kinetix Motion Accessories Technical Data, publication [KNX-TD004](#), for connector kit catalog numbers and cable specifications. Cable length xx is in meters. For information on maximum cable lengths see Kinetix 5700 Servo Drives User Manual, publication [2198-UM002](#).

Kinetix MPAI Performance Specifications with Kinetix 5700 (400V-class) Drives

Performance Specifications with Ball Screw Electric Cylinders

Electric Cylinder Cat. No.	Maximum Speed mm/s (in/s)	System Continuous Stall Current Amps 0-pk	System Continuous Stall Force N (lb)		System Peak Stall Current Amps 0-pk	System Peak Stall Force N (lb)	Motor Output Power Rating kW	Kinetix 5700 Drives (480V AC input)
			25 °C (77 °F)	40 °C (104 °F)				
MPAI-B2076CV1	305 (12)	0.90	890 (200)	706 (159)	2.30	1446 (325)	0.22	2198-D006-ERSx
MPAI-B2150CV3		1.29	1446 (325)	1147 (258)	3.25			
MPAI-B2300CV3								
MPAI-B3076CM1	305 (12)	1.35	1624 (365)	1290 (290)	4.57	4448 (1000)	0.27	2198-D006-ERSx
MPAI-B3076EM1	610 (24)		814 (183)	645 (145)		2570 (578)		
MPAI-B3150CM3	279 (11)	2.81	4003 (900)	3176 (714)	4.30	4448 (1000)	0.39	2198-D006-ERSx
MPAI-B3300CM3								
MPAI-B3450CM3	188 (7.3)							
MPAI-B3150EM3	559 (22)		2002 (450)	1588 (357)	7.07	4003 (900)		
MPAI-B3300EM3								
MPAI-B3450EM3	376 (15)							
MPAI-B4150CM3	279 (11)	5.61	7784 (1750)	6179 (1389)	8.68	8896 (2000)	0.43	2198-D012-ERSx
MPAI-B4300CM3								
MPAI-B4450CM3	245 (9.5)							
MPAI-B4150EM3	559 (22)		3892 (875)	3092 (695)	14.14	7784 (1750)		
MPAI-B4300EM3								
MPAI-B4450EM3	491 (19)							
MPAI-B5xxxCM3	200 (7.8)	6.62	13,123 (2950)	10,415 (2341)	8.48	13,345 (3000)	0.55	2198-D012-ERSx
MPAI-B5xxxEM3	400 (15.6)		6562 (1475)	5208 (1171)	16.70	13,122 (2950)		

Performance specification data and curves reflect nominal system performance of a typical system with the motor ambient at 40 °C (104 °F), drive ambient at 50 °C (122 °F), and rated line voltage. For additional information on ambient and line conditions, refer to Motion Analyzer software.

Performance Specifications with Roller Screw Electric Cylinders

Electric Cylinder Cat. No.	Maximum Speed mm/s (in/s)	System Continuous Stall Current Amps 0-pk	System Continuous Stall Force N (lb)		System Peak Stall Current Amps 0-pk	System Peak Stall Force N (lb)	Motor Output Power Rating kW	Kinetix 5700 Drives (480V AC input)
			25 °C (77 °F)	40 °C (104 °F)				
MPAI-B3076RM1	305 (12)	1.45	1557 (350)	1237 (278)	4.57	4862 (1093)	0.27	2198-D006-ERSx
MPAI-B3076SM1	610 (24)		778 (175)	618 (139)		2431 (547)		
MPAI-B3150RM3	279 (11)	2.81	3781 (850)	3003 (675)	7.07	7562 (1700)	0.39	2198-D006-ERSx
MPAI-B3300RM3								
MPAI-B3450RM3	176 (6.9)							
MPAI-B3150SM3	559 (22)		1891 (425)	1499 (337)		3781 (850)		
MPAI-B3300SM3								
MPAI-B3450SM3	353 (14)							
MPAI-B4150RM3	279 (11)	5.61	7340 (1650)	5827 (1310)	14.14	14,679 (3300)	0.43	2198-D012-ERSx
MPAI-B4300RM3								
MPAI-B4450RM3	196 (7.6)							
MPAI-B4150SM3	559 (22)		3670 (825)	2914 (655)		7340 (1650)		
MPAI-B4300SM3								
MPAI-B4450SM3	393 (15)							

Performance specification data and curves reflect nominal system performance of a typical system with the motor ambient at 40 °C (104 °F), drive ambient at 50 °C (122 °F), and rated line voltage. For additional information on ambient and line conditions, refer to Motion Analyzer software.

Kinetix 5700 Drives/Kinetix MPAI (ball screw) Electric Cylinder Curves

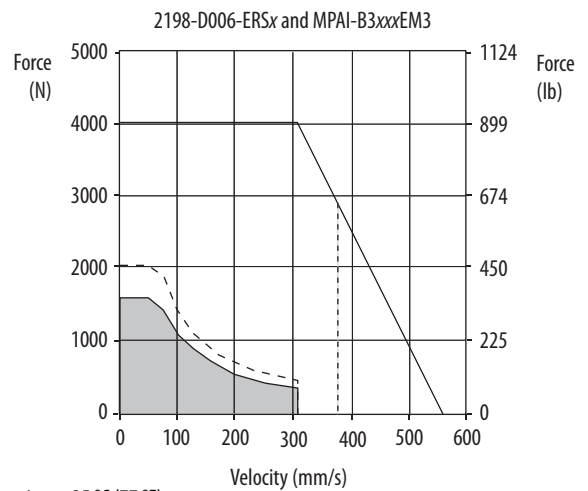
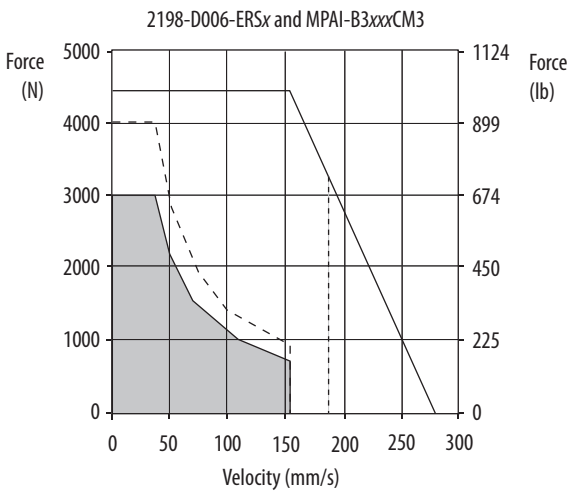
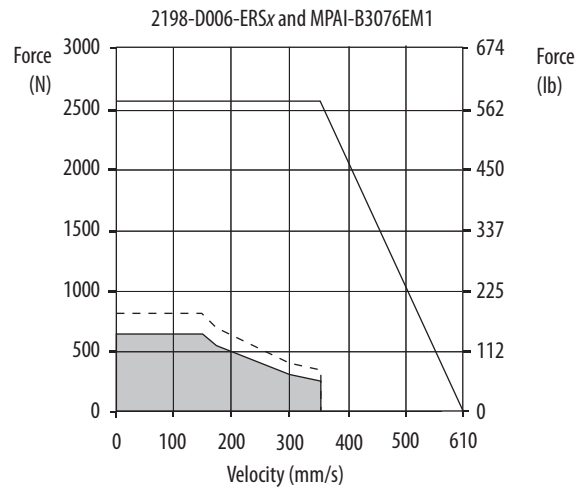
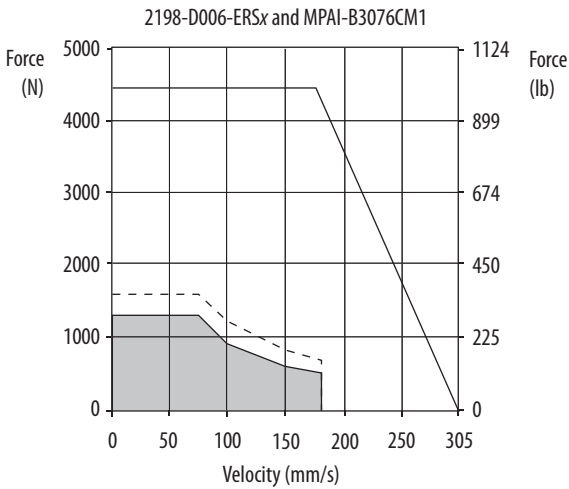
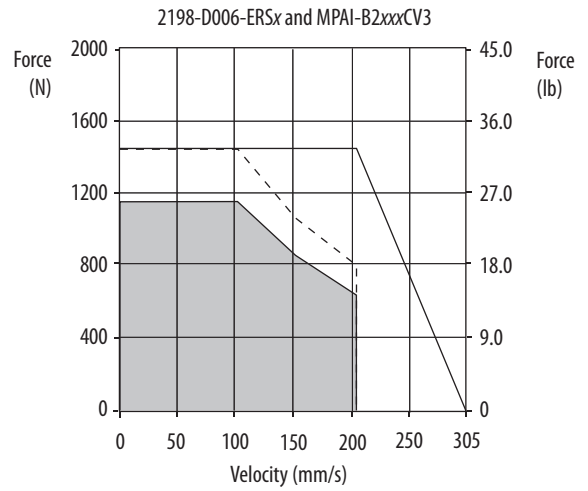
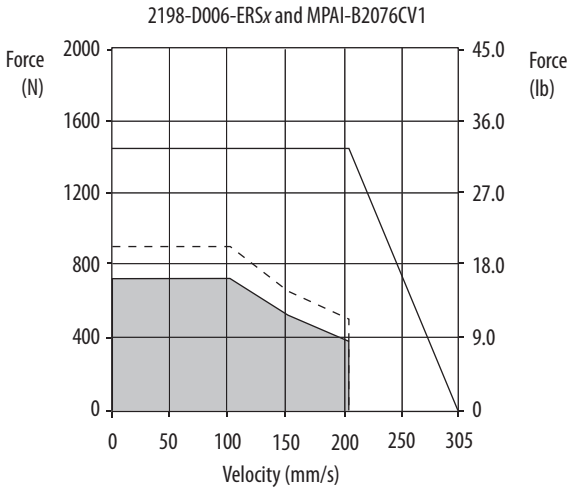

- = Continuous operating region @ 25 °C (77 °F)
- = Continuous operating region @ 40 °C (104 °F)
- - - = Intermittent operating region, 450 mm (18 in.) stroke length only
- = Intermittent operating region, 076...300 mm (3...12 in.) stroke lengths

Kinetix 5700 Drives/Kinetix MPAI (ball screw) Electric Cylinder Curves (continued)

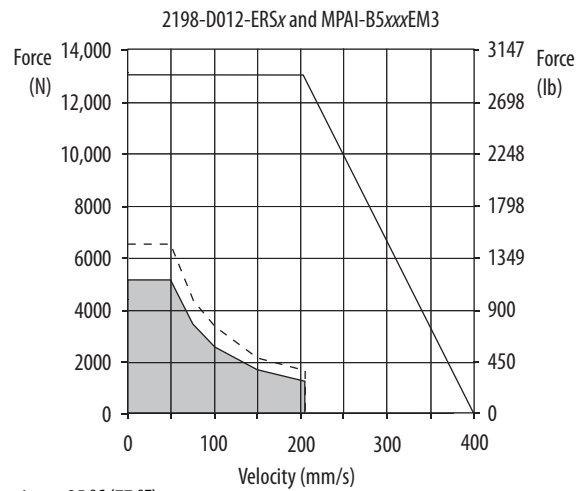
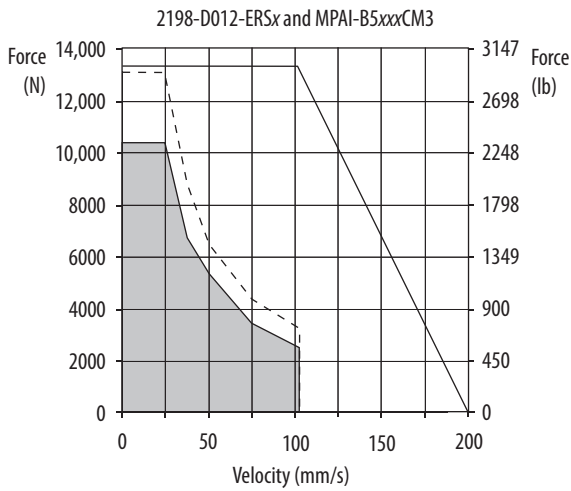
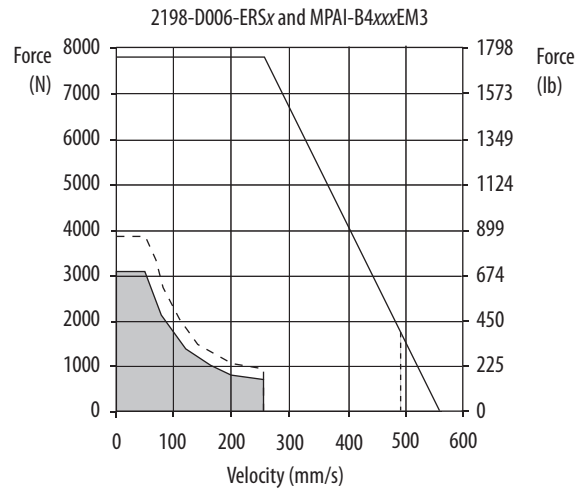
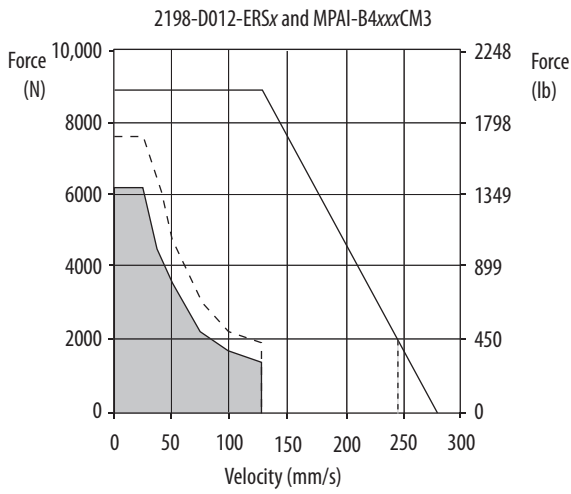

- = Continuous operating region @ 25 °C (77 °F)
- = Continuous operating region @ 40 °C (104 °F)
- = Intermittent operating region, 450 mm (18 in.) stroke length only
- = Intermittent operating region, 076...300 mm (3...12 in.) stroke lengths

Kinetix 5700 Drives/Kinetix MPAI (roller screw) Electric Cylinder Curves

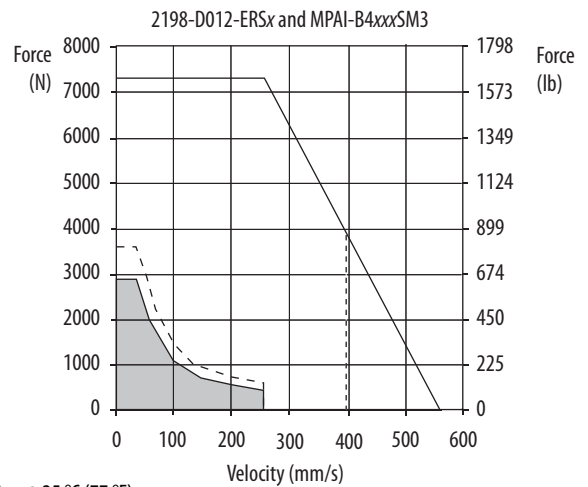
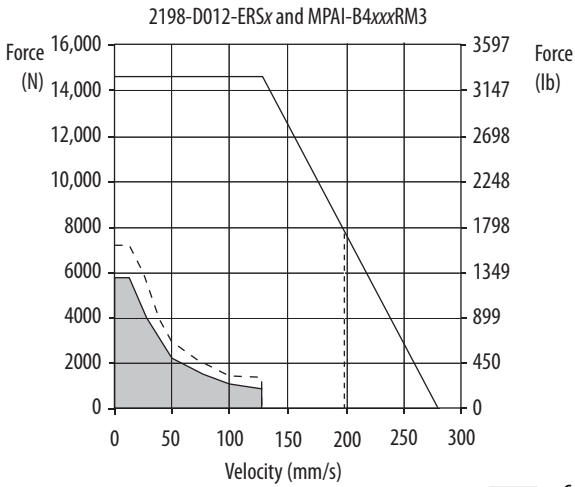
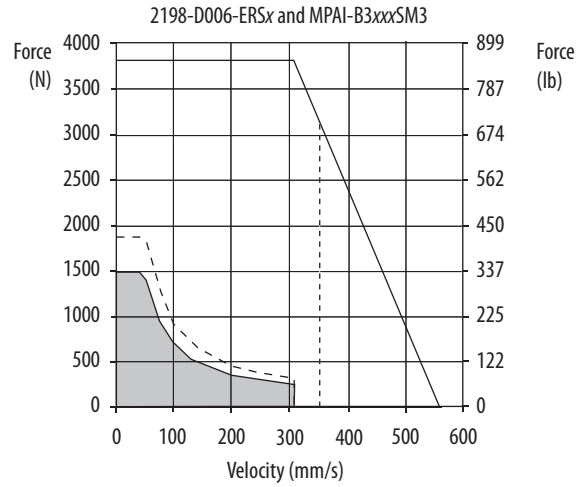
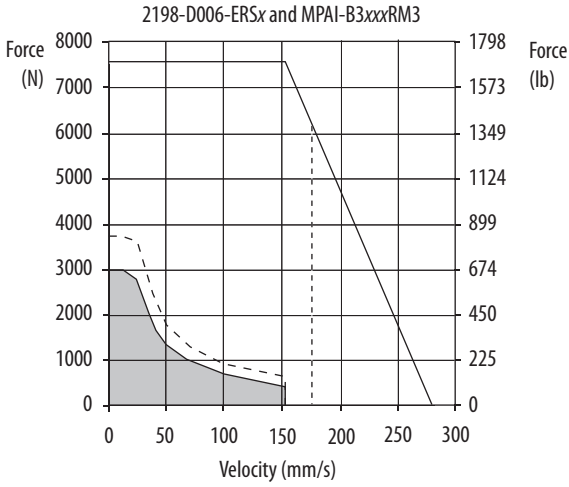
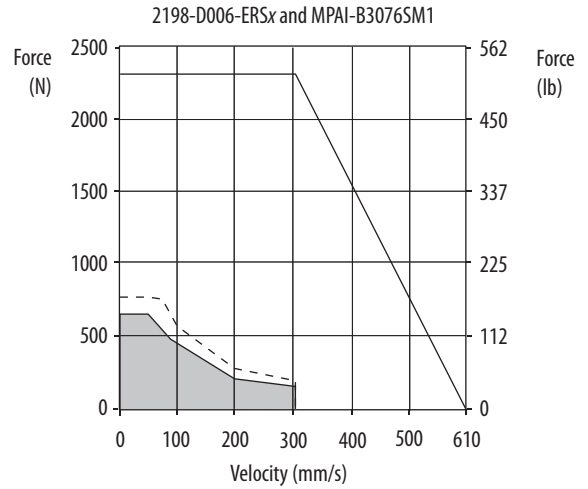
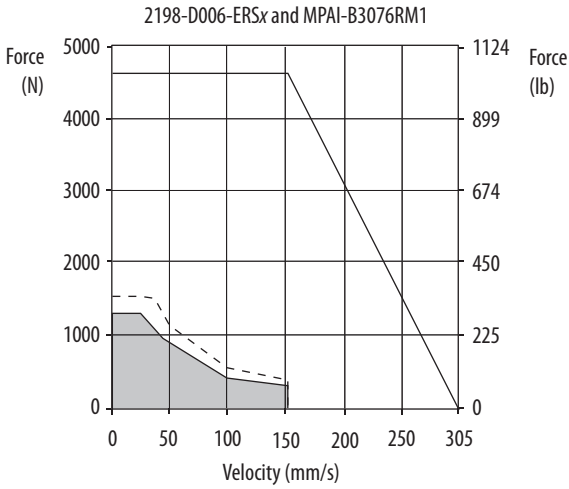

- = Continuous operating region @ 25 °C (77 °F)
- █ = Continuous operating region @ 40 °C (104 °F)
- - - = Intermittent operating region, 450 mm (18 in.) stroke length only
- = Intermittent operating region, 076...300 mm (3...12 in.) stroke lengths

Kinetix 5700 (400V-class) Drives with LDC-Series Iron-core Linear Motors

This section provides system combination information for the Kinetix 5700 drives (with 400 and 480V, nominal input) when matched with LDC-Series linear motors. Included are motor power and feedback cable catalog numbers, system performance specifications, and the optimum force/velocity curves.

LDC-Series Cable Combinations

Linear Motor Cat. No.	Motor Power Cable	Motor Feedback Cable ⁽¹⁾
LDC-C030100-DHT, LDC-C030200-DHT, LDC-C030200-EHT	2090-CPWM7DF-16AAxx (standard, non-flex) 2090-CPWM7DF-16AFxx (continuous-flex)	2090-XXNFMF-Sxx (standard, non-flex) 2090-CFBM7DF-CDAFxx (continuous-flex) Sin/Cos or TTL Encoder Feedback
LDC-C050100-DHT, LDC-C050200-DHT, LDC-C050200-EHT, LDC-C050300-DHT, LDC-C050300-EHT		
LDC-C075200-DHT, LDC-C075200-EHT, LDC-C075300-DHT, LDC-C075300-EHT, LDC-C075400-DHT, LDC-C075400-EHT		
LDC-C100300-DHT, LDC-C100300-EHT, LDC-C100400-DHT, LDC-C100400-EHT, LDC-C100600-DHT		
LDC-C150400-DHT, LDC-C150600-DHT		

(1) Use the 2198-K57CK-D15M feedback connector kit with flying-lead cables on the drive end. Refer to Required Drive Accessories on [page 11](#).

For cable configuration illustrations and feature descriptions, by catalog number, refer to 2090-Series Motor Power/Brake and Feedback Cables Overview beginning on [page 19](#). Motor-end connector kits, and panel-mounted breakout components (drive end), are available for motor power and feedback cables. Refer to the Kinetix Motion Accessories Technical Data, publication [KNX-TD004](#), for connector kit catalog numbers and cable specifications. Cable length xx is in meters. For information on maximum cable lengths see Kinetix 5700 Servo Drives User Manual, publication [2198-UM002](#).

LDC-Series Performance Specifications with Kinetix 5700 (400V-class) Drives

Linear Motor Cat. No.	Maximum Speed m/s (ft/s)	System Continuous Stall Current ⁽¹⁾ Amps 0-pk	System Continuous Stall Force ⁽¹⁾ N (lb)	System Peak Stall Current Amps 0-pk	System Peak Stall Force N (lb)	Linear Motor Rated Output kW	Kinetix 5700 Drives (480V AC input)	
LDC-C030100-DHT	10.0 (32.8)	4.1...6.1	74...111 (17...25)	12.1	188 (42)	0.37...0.55	2198-D012-ERSx	
LDC-C030200-DHT		8.1...12.2	148...222 (33...50)	24.3	375 (84)	0.74...1.11	2198-D020-ERSx	
LDC-C030200-EHT		4.1...6.1		12.1			2198-D012-ERSx	
LDC-C050100-DHT	10.0 (32.8)	3.9...5.9	119...179 (27...40)	11.7	302 (68)	0.59...0.89	2198-D012-ERSx	
LDC-C050200-DHT		7.9...11.8	240...359 (54...81)	23.3	600 (135)	1.20...1.79	2198-D020-ERSx	
LDC-C050200-EHT		3.9...5.9		11.6			2198-D012-ERSx	
LDC-C050300-DHT		11.8...17.7	363...544 (82...122)	35.9	941 (212)	1.81...2.72	2198-D032-ERSx	
LDC-C050300-EHT		3.9...5.9		12.0			2198-D012-ERSx	
LDC-C075200-DHT		7.7...11.5		348...523 (78...117)			22.9	882 (198)
LDC-C075200-EHT		3.8...5.7	11.5		2198-D012-ERSx			
LDC-C075300-DHT	10.0 (32.8)	11.5...17.2	523...784 (117...176)	35.6	1368 (308)	2.61...3.92	2198-D032-ERSx	
LDC-C075300-EHT		3.8...5.7	11.9	2198-D012-ERSx				
LDC-C075400-DHT		15.3...23.0	697...1045 (157...235)	47.4	1824 (410)	3.48...5.22	2198-D032-ERSx	
LDC-C075400-EHT		7.7...11.5	23.7	2198-D020-ERSx				
LDC-C100300-DHT		10.0 (32.8)	11.1...16.7	674...1012 (152...227)	34.3	1767 (397)	3.37...5.06	2198-D032-ERSx
LDC-C100300-EHT			3.7...5.6	11.4	2198-D012-ERSx			
LDC-C100400-DHT	14.8...22.2		899...1349 (202...303)	45.7	2356 (530)	4.49...6.74	2198-D032-ERSx	
LDC-C100400-EHT	7.4...11.1		22.8	2198-D020-ERSx				
LDC-C100600-DHT	22.2...33.3		1349...2023 (303...455)	68.5	3534 (794)	6.74...10.11	2198-D057-ERSx	
LDC-C100600-EHT	11.1...16.7		34.3	2198-D032-ERSx				
LDC-C150400-DHT	10.0 (32.8)		14.1...21.1	1281...1922 (288...432)	45.2	3498 (786)	6.40...9.61	2198-D032-ERSx
LDC-C150400-EHT			7.0...10.6	22.6	2198-D020-ERSx			
LDC-C150600-DHT		21.1...31.7	1922...2882 (432...648)	67.8	5246 (1179)	9.61...14.41	2198-D057-ERSx	
LDC-C150600-EHT		10.6...15.8	33.9	2198-D032-ERSx				

(1) Values represent the range between no cooling (low value) and water cooling (high value).

Performance specification data and curves reflect nominal system performance of a typical system with the motor ambient at 40 °C (104 °F), drive ambient at 50 °C (122 °F), and rated line voltage. For additional information on ambient and line conditions, refer to Motion Analyzer software.

Kinetix 5700 (400V-class) Drives/LDC-Series Linear Motor Curves

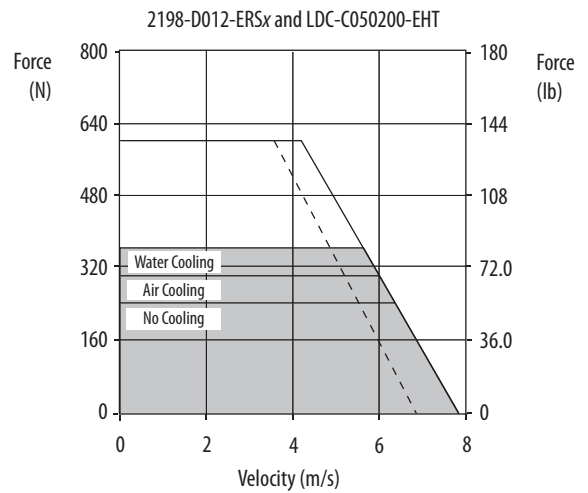
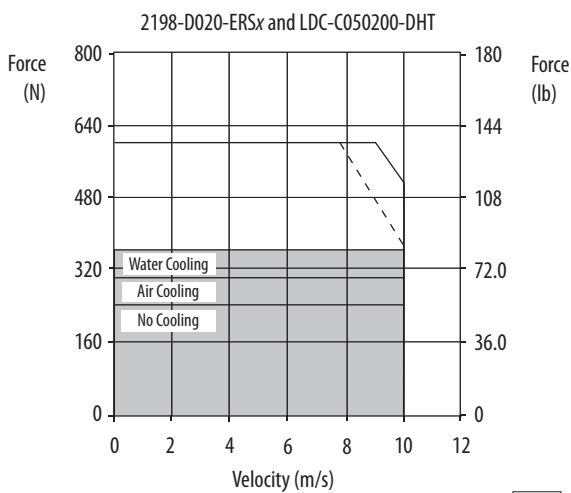
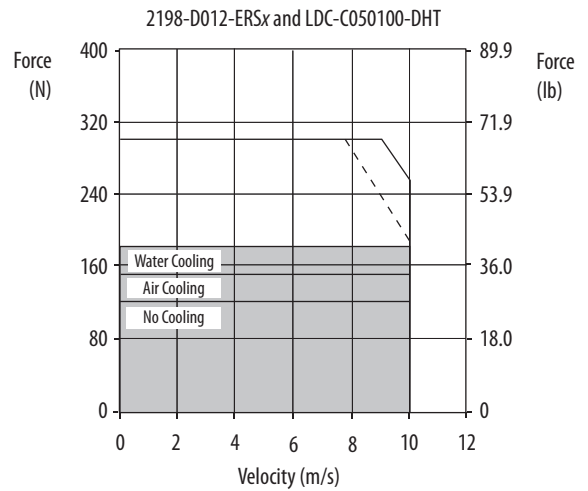
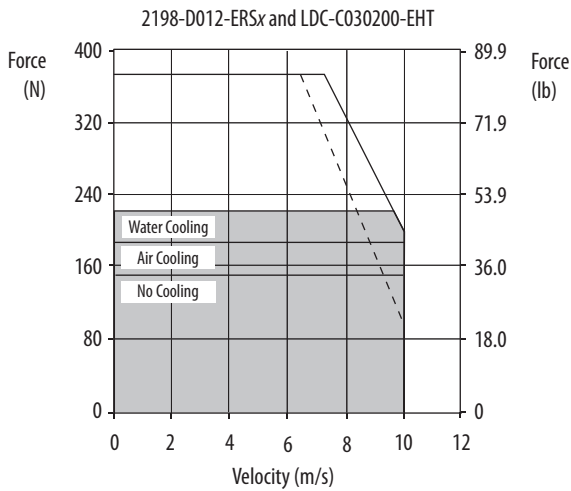
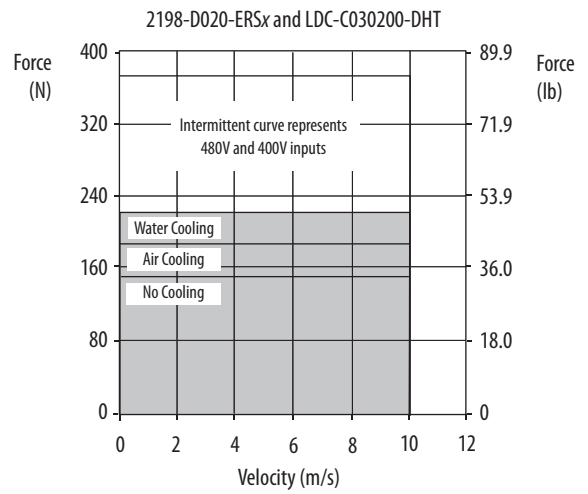
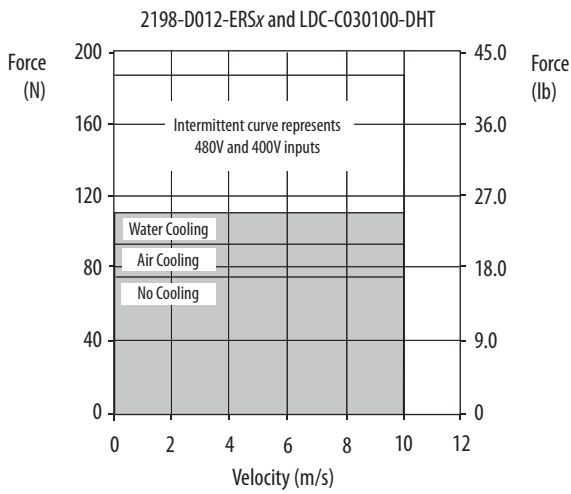

- = Intermittent operating region
- = Continuous operating region
- = Drive operation with 400V AC rms input voltage

Kinetix 5700 (400V-class) Drives/LDC-Series Linear Motor Curves (continued)

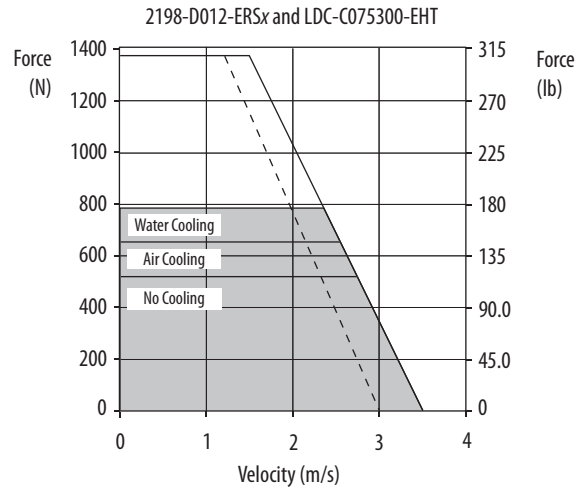
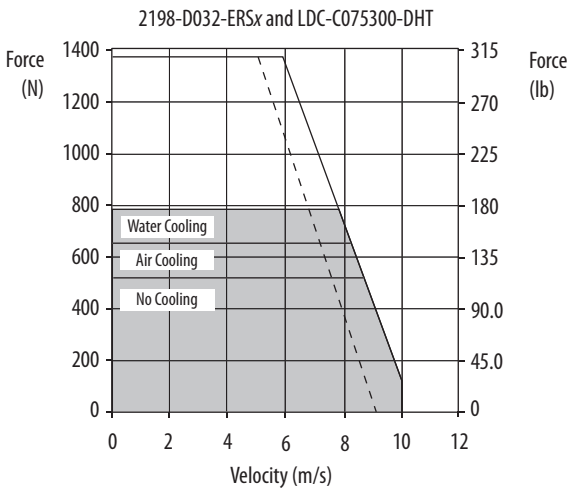
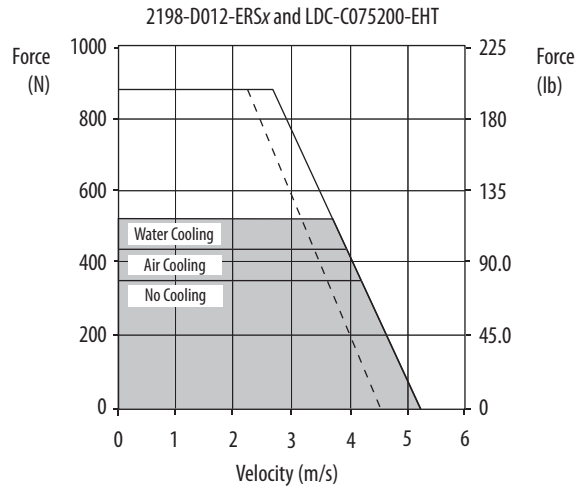
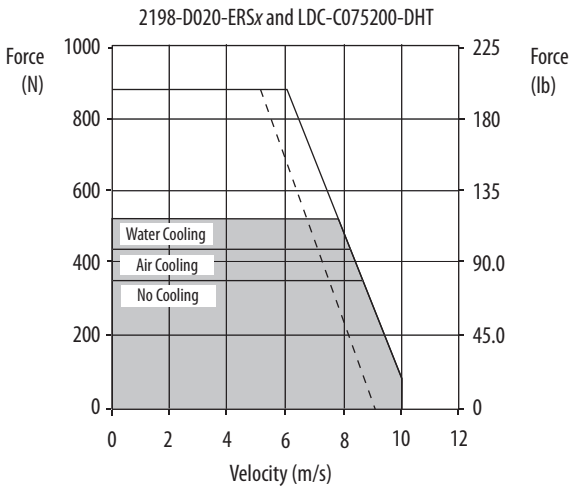
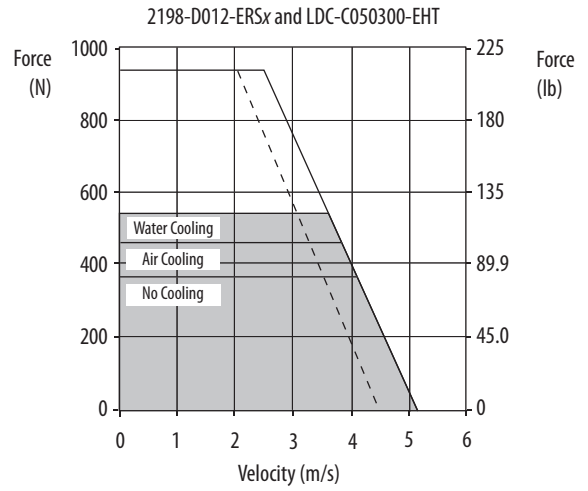
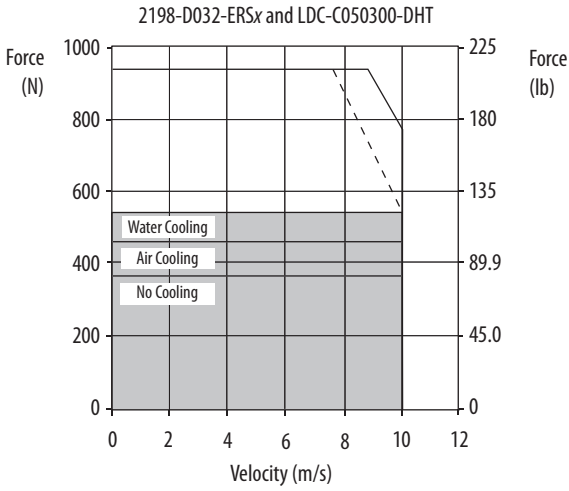

= Intermittent operating region
 = Continuous operating region
 = Drive operation with 400V AC rms input voltage

Kinetix 5700 (400V-class) Drives/LDC-Series Linear Motor Curves (continued)

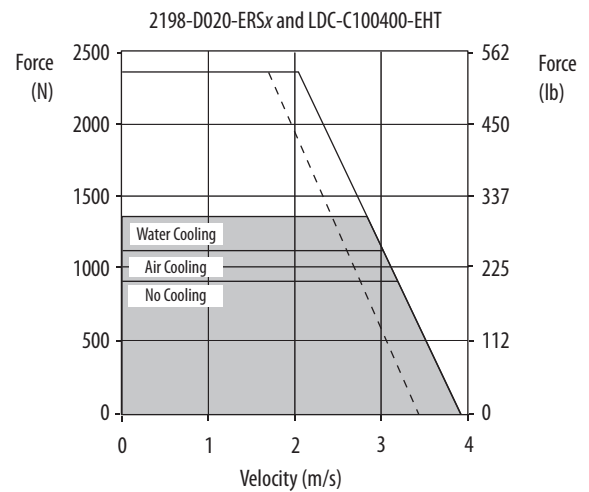
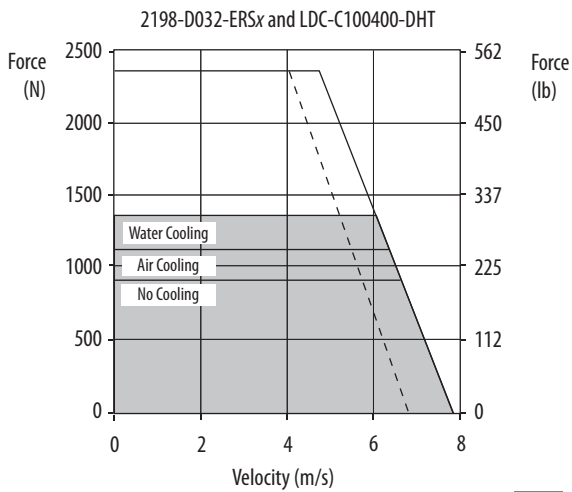
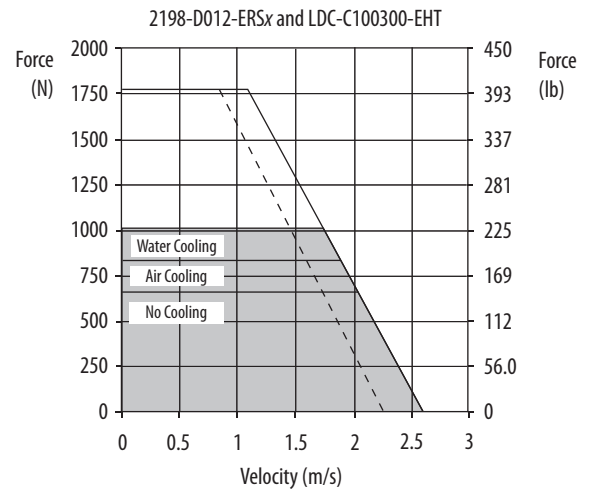
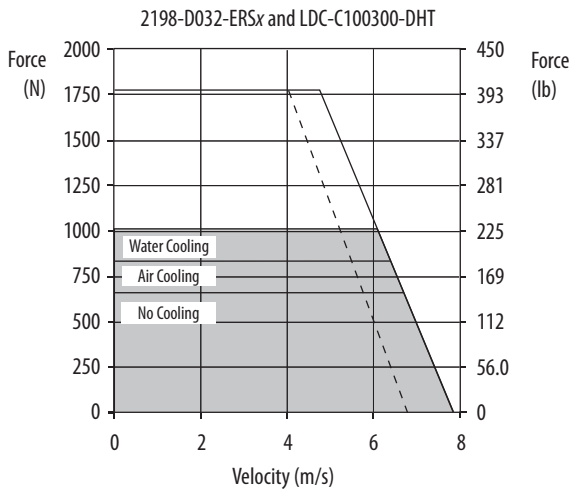
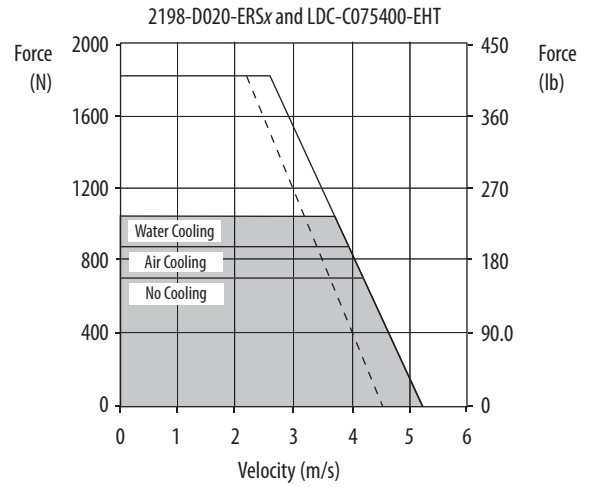
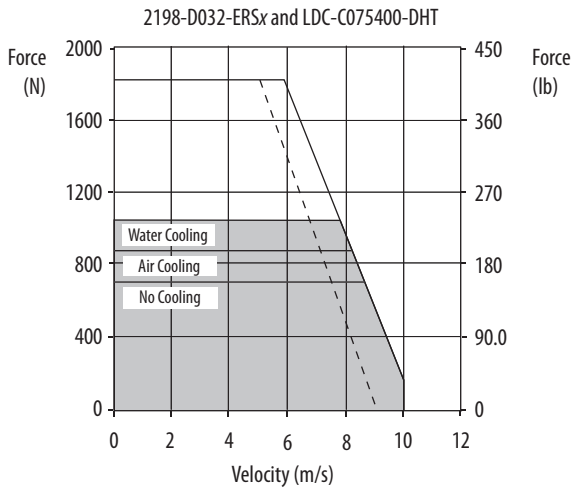

= Intermittent operating region
 = Continuous operating region
 = Drive operation with 400V AC rms input voltage

Kinetix 5700 (400V-class) Drives/LDC-Series Linear Motor Curves (continued)

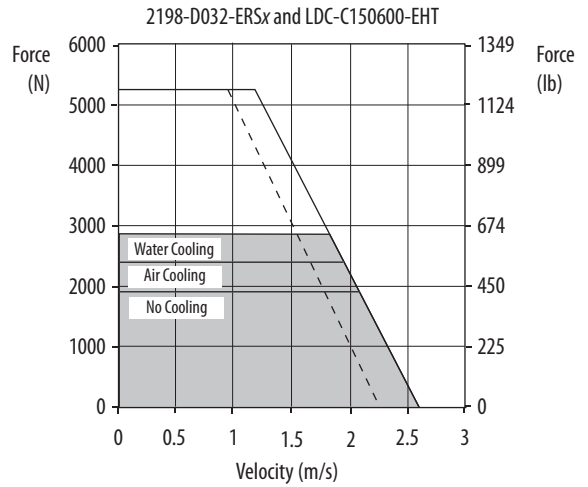
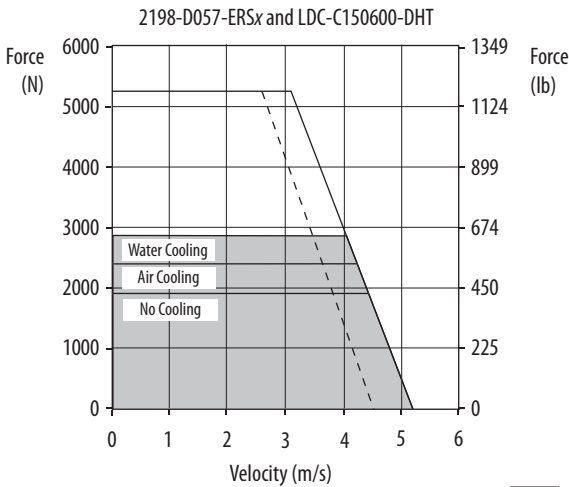
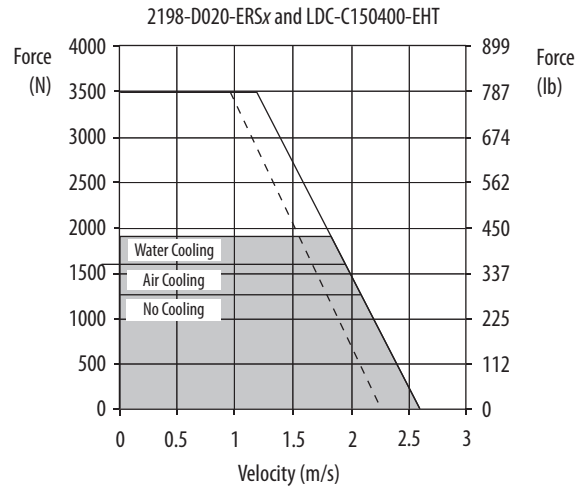
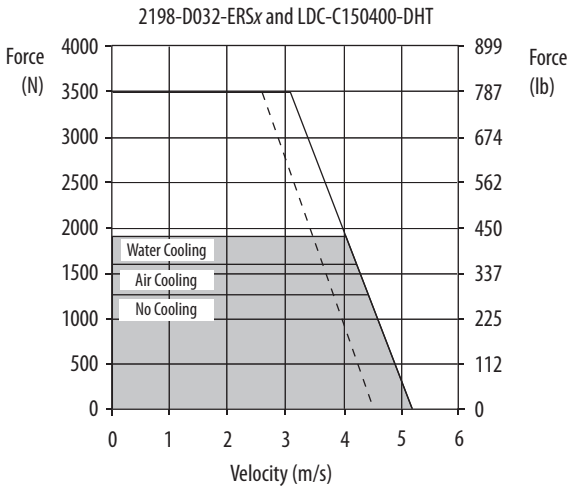
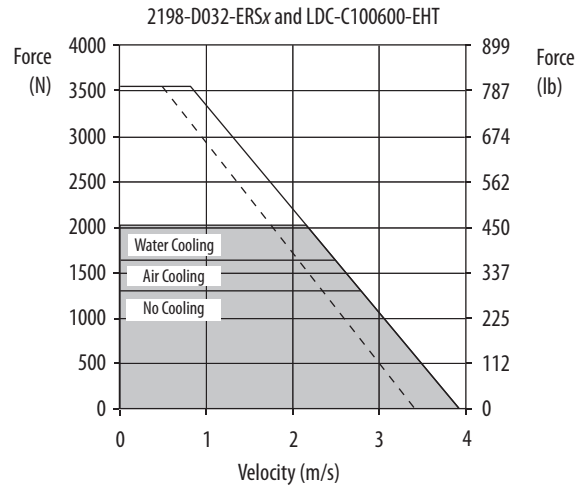
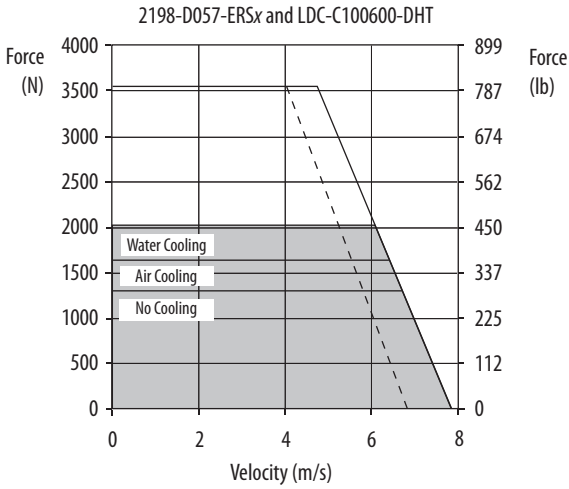

- = Intermittent operating region
- = Continuous operating region
- = Drive operation with 400V AC rms input voltage

Additional Resources

These documents contain additional information concerning related products from Rockwell Automation.

Resource	Description
Kinetix Rotary Motion Specifications, publication KNX-TD001	Product specifications for Kinetix VP, Kinetix MP, Kinetix TL and TLY, Kinetix RDB, and Kinetix HPK rotary motors.
Kinetix Linear Motion Specifications, publication KNX-TD002	Provides product specifications for Kinetix MPAS and MPMA linear stages, Kinetix VPAR, MPAR, and MPAL electric cylinders, and LDC-Series and LDL-Series linear motors.
Kinetix Servo Drives Specifications, publication KNX-TD003	Provides product specifications for Kinetix Integrated Motion over the EtherNet/IP network, Integrated Motion over sercos interface, EtherNet/IP networking, and component servo drive families.
Kinetix Motion Accessories Specifications, publication KNX-TD004	Provides product specifications for 2090-Series motor and interface cables, low-profile connector kits, drive power components, and other servo drive accessory items.
Kinetix Halogen-free PUR and PVC Single Motor Cables Quick Reference, publication 2090-QR002	Provides product specifications comparing 2090-CSBM1Dx-xxLFxx (Halogen-free PUR) and 2090-CSxM1Dx-xxVAxx (PVC) single motor cables.
Kinetix 5700 Servo Drives User Manual, publication 2198-UM002	Provides information on how to install, configure, startup, and troubleshoot your Kinetix 5700 servo drive system.
Kinetix 5700 Safe Monitor Functions Safety Reference Manual, publication 2198-RM001	Provides information on safety functions available with 2198-xxxx-ERS4 dual-axis and single-axis inverters. Includes Studio 5000 Logix Designer configuration and troubleshooting for your Kinetix 5700 servo drive system.
Kinetix Motion Control Selection Guide, publication KNX-SG001	Provides overview of Kinetix servo drives, motors, actuators, and motion accessories designed to help make initial decisions for the motion control products best suited for your system requirements.
Kinetix 5500 Drive Systems Design Guide, publication KNX-RM009	Provides system design guide to determine and select the required (drive specific) drive module, power accessory, connector kit, motor cable, and interface cable catalog numbers for your drive and motor/actuator motion control system. Included are system performance specifications and torque/speed curves (rotary motion) and force/velocity curves (linear motion) for your motion application.
Kinetix 5100 Drive Systems Design Guide, publication KNX-RM011	
Kinetix 6000 and Kinetix 6200/6500 Drive Systems Design Guide, publication KNX-RM003	
Kinetix 300/350 Drive Systems Design Guide, publication KNX-RM004	
Kinetix 3 Drive Systems Design Guide, publication KNX-RM005	
Kinetix 2000 Drive Systems Design Guide, publication KNX-RM006	
Kinetix 7000 Drive Systems Design Guide, publication GMC-RM007	
System Design for Control of Electrical Noise Reference Manual, publication GMC-RM001	Provides information, examples, and techniques designed to minimize system failures caused by electrical noise.
ControlLogix Selection Guide, publication 1756-SG001	Provides information to determine which ControlLogix controller fits your application and the product specifications to help design a ControlLogix system and select the appropriate components.
CompactLogix Selection Guide, publication 1769-SG001	Provides information to determine which CompactLogix controller fits your application and the product specifications to help design a CompactLogix system and select the appropriate components.
Industrial Ethernet Media Brochure, publication 1585-BR001	Provides information to determine which Bulletin 1585 Ethernet cable fits your application and the product specifications to help select the appropriate components.
Motion Analyzer System Sizing and Selection Tool website https://motionanalyzer.rockwellautomation.com/	Provides comprehensive motion application sizing tool used for analysis, optimization, selection, and validation of your Kinetix Motion Control system.
Rockwell Automation Configuration and Selection Tools, website http://ab.rockwellautomation.com	Provides online product selection and system configuration tools, including AutoCAD (DXF) drawings.
Product Certifications website, rok.auto/certifications	Provides declarations of conformity, certificates, and other certification details.
Rockwell Automation Industrial Automation Glossary, publication AG-7.1	A glossary of industrial automation terms and abbreviations.

You can view or download publications at <http://www.rockwellautomation.com/global/literature-library/overview.page>.

Rockwell Automation Support

Use the following resources to access support information.

Technical Support Center	Knowledgebase Articles, How-to Videos, FAQs, Chat, User Forums, and Product Notification Updates.	www.rockwellautomation.com/knowledgebase
Local Technical Support Phone Numbers	Locate the phone number for your country.	www.rockwellautomation.com/global/support/get-support-now.page
Direct Dial Codes	Find the Direct Dial Code for your product. Use the code to route your call directly to a technical support engineer.	www.rockwellautomation.com/global/support/direct-dial.page
Literature Library	Installation Instructions, Manuals, Brochures, and Technical Data.	www.rockwellautomation.com/literature
Product Compatibility and Download Center (PCDC)	Get help determining how products interact, check features and capabilities, and find associated firmware.	www.rockwellautomation.com/global/support/pcdc.page

Documentation Feedback

Your comments will help us serve your documentation needs better. If you have any suggestions on how to improve this document, complete the How Are We Doing? form at http://literature.rockwellautomation.com/idc/groups/literature/documents/du/ra-du002_-en-e.pdf.

Rockwell Automation maintains current product environmental information on its website at <http://www.rockwellautomation.com/rockwellautomation/about-us/sustainability-ethics/product-environmental-compliance.page>.

Allen-Bradley, CompactLogix, ControlLogix, Encompass, FactoryTalk, GuardLogix, Kinetix, LDC-Series, LISTEN. THINK. SOLVE., Logix 5000, PanelView, POINT Guard I/O, POINT I/O, PowerFlex, Rockwell Automation, Rockwell Software, Stratix, Studio 5000, and Studio 5000 Logix Designer are trademarks of Rockwell Automation, Inc.

EtherNet/IP and CIP Security are trademarks of ODVA, Inc.

Trademarks not belonging to Rockwell Automation are property of their respective companies.

Rockwell Otomasyon Ticaret A.Ş., Kar Plaza İş Merkezi E Blok Kat:6 34752 İçerenköy, İstanbul, Tel: +90 (216) 5698400

www.rockwellautomation.com

Power, Control and Information Solutions Headquarters

Americas: Rockwell Automation, 1201 South Second Street, Milwaukee, WI 53204-2496 USA, Tel: (1) 414.382.2000, Fax: (1) 414.382.4444

Europe/Middle East/Africa: Rockwell Automation NV, Pegasus Park, De Kleetlaan 12a, 1831 Diegem, Belgium, Tel: (32) 2 663 0600, Fax: (32) 2 663 0640

Asia Pacific: Rockwell Automation, Level 14, Core F, Cyberport 3, 100 Cyberport Road, Hong Kong, Tel: (852) 2887 4788, Fax: (852) 2508 1846

Publication KNX-RM010J-EN-P - February 2020

Supersedes Publication KNX-RM010I-EN-P - December 2019

Copyright © 2020 Rockwell Automation, Inc. All rights reserved. Printed in the U.S.A.